



2021  
Catalog  
of dreams

# Unilock. The Original

## Trust The Best

*When the time is right to create a truly exceptional outdoor space, from driveways and entrances, to backyard sanctuaries, and more, trust the original to make your dreams come true.*

*“Unilock helped us create our dream outdoor living space. We practically live in it now! Thank you Unilock!”*

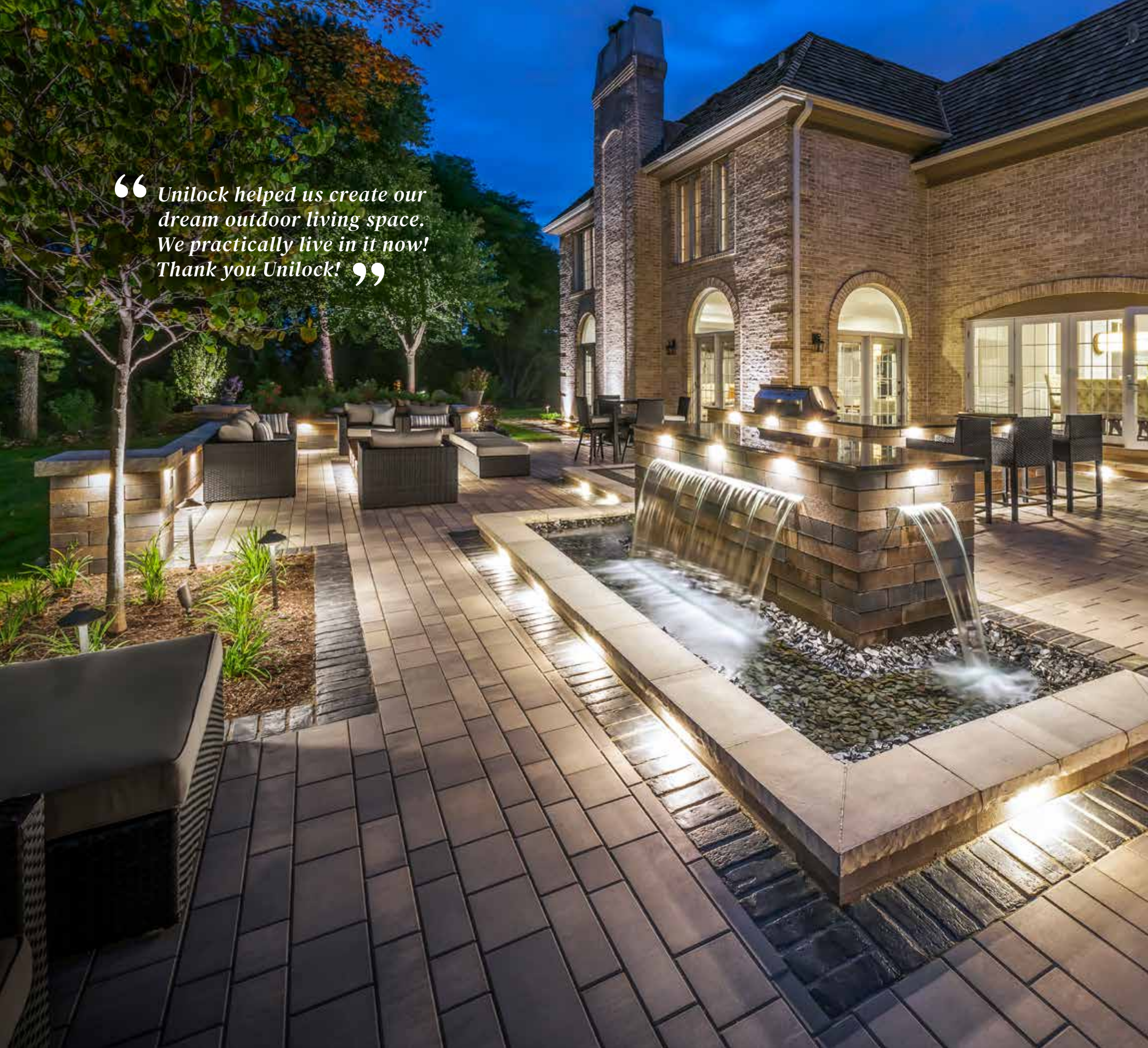

**What's  
inside**



## 8 Dream

---

*If you can dream it,  
we can make it happen!*

- 10 Outdoor Living
- 20 Pool Decks
- 26 Driveways
- 32 Entrances & Walkways
- 38 Urban spaces

## 42 Products

---

*Unilock makes your landscape dreams  
come true with the highest quality  
products in the industry.*

- 46 Pavers & Slabs
- 112 Retaining Walls & Vertical Features
- 134 Steps, Treads, Coping & Caps
- 142 Making Your Project Unique

## 152 Where Do I Begin?

---

*Now that you've been inspired by our  
products and ideas, it's time to get  
down to the nitty gritty.*

- 154 Learn about Unilock Products
- 159 Learn about the Process
- 162 Find a Contractor
- 164 Protect your Investment
- 166 Prestigious Public Spaces
- 168 Unilock Guarantee

# 10 Reasons to Choose Unilock

There's more to a successful project than what you see on the finished surface.

## 1 STYLES YOU CAN'T GET ANYWHERE ELSE



From the sleek, contemporary look of Umbriano™ to the timeless feel of weathered European cobblestones and everything in between, Unilock® has something for everyone's landscape dreams.

## 2 UNILOCK IDEA CENTER



The Unilock Outdoor Idea Center is a real place where you can walk through inspiring displays of Unilock products in a full-scale outdoor setting. Let our friendly customer service staff show you our amazing products and help you create your dream plan. We'll even provide you with **free product samples**.

We're here to help you every step of the way.



**Unilock Outdoor Idea Center**  
301 E. Sullivan Rd. Aurora, IL 60505

## 3 ADVANCED TECHNOLOGY



With products to suit every budget and a huge variety of material types, Unilock will make your landscape dreams come true!

- > **EasyClean™ Stain Resistance**  
Factory sealed to provide integral surface protection from stains
- > **Reala™ Technology**  
Cast from natural stone, brick and historic European cobblestones
- > **Ultima™ Concrete Technology**  
Up to 4x stronger than poured-in-place concrete
- > **ColorFusion™ Technology**  
Randomly dispersed color and granite particles

## 4 GREENER CHOICES - WATER MANAGEMENT



We began selling permeable pavers more than 25 years ago and have more experience in this area than any other manufacturer. Permeable pavers are a popular choice to unlock useable space in municipalities where non-permeable lot coverage is restricted. They allow water to flow through extra wide joints to replenish the natural eco-system.

 This icon indicates permeable products.

## 5 UNSURPASSED DURABILITY



There isn't a better paving product in the world. Unilock products set the standard for quality in the industry.

Every Unilock product is...

- > **Durable**
- > **Made with colorfast pigments**
- > **Slip resistant**
- > **Resistant to salt erosion**
- > **Designed to tolerate oil and gas spills**
- > **Backed by our Transferable Lifetime Guarantee**





## 6 THE GO-TO PRODUCT FOR PROFESSIONALS

There's good reason why the pros choose Unilock products. From architects and landscape architects to city engineers and commercial property owners, Unilock is preferred by professionals.

Many of the products featured in this catalog have been installed in large scale commercial projects in some of the most prestigious spaces in North America. **If we're the choice of the pros, shouldn't you choose us, too?**

## 7 MORE EXPERIENCE THAN ANYONE ELSE

Founded in 1972, Unilock was the first to manufacture paving stones in North America. Over the past 48 years, we have perfected our manufacturing process and have developed technologies to create products that set the bar for innovation and creativity.

Our world-class production facilities are renowned for their safety and cleanliness and are staffed with the most experienced production people in the industry.

This, in combination with our ongoing investment in technologically advanced equipment, ensures we're able to provide the best in quality, consistency and design.



## 8 UNBEATABLE PRODUCT GUARANTEE

Unilock was the first to offer a transferable Lifetime Guarantee on our manufactured products. That's quite the commitment since we have almost 2 billion stones on the ground! You can sleep well at night knowing that **Unilock is behind you 100%**.

## 9 GUARANTEED TO DO THE JOB RIGHT

A product is only as good as the workmanship used to install it. Unilock Authorized Contractors are rigorously screened and hand-picked for their quality workmanship and exceptional business practices which enables us to guarantee their workmanship for a period of two years. When you choose a Unilock Authorized Contractor, you can be assured that you are getting the best in the business.

## 10 WE'RE HERE TO HELP

Unilock is a family owned company that cares about the success of your project. Contractors know that help from Unilock is only a phone call away and we're committed to providing the best customer experience in the industry.

Outdoor Living  
Pool Decks  
Driveways  
Entrances & Walkways  
Urban Spaces

# Dream

**If you can dream it,  
we can make it happen!**

*Whether you're dreaming of an intimate patio, a practical driveway or a luxurious outdoor living space, Unilock has everything you need to make your dream come true.*





# Unlock the Possibilities!

## Outdoor Living

---

Imagine extending your living space outdoors. An elegant and beautiful backyard not only adds tremendous value to your home, it also adds wonderful opportunities for your family to enjoy time together.

**Pavers:** Umbriano™ (Winter Marvel) with Copthorne® (Basalt) accent  
**Wall:** Rivercrest™ Wall (Coastal Slate) with Copthorne (Basalt) accent and LedgeStone™ (Grey) coping and pillar caps

*“ We have a great time out here with our family. We couldn't be happier with our Unilock patio. ”*

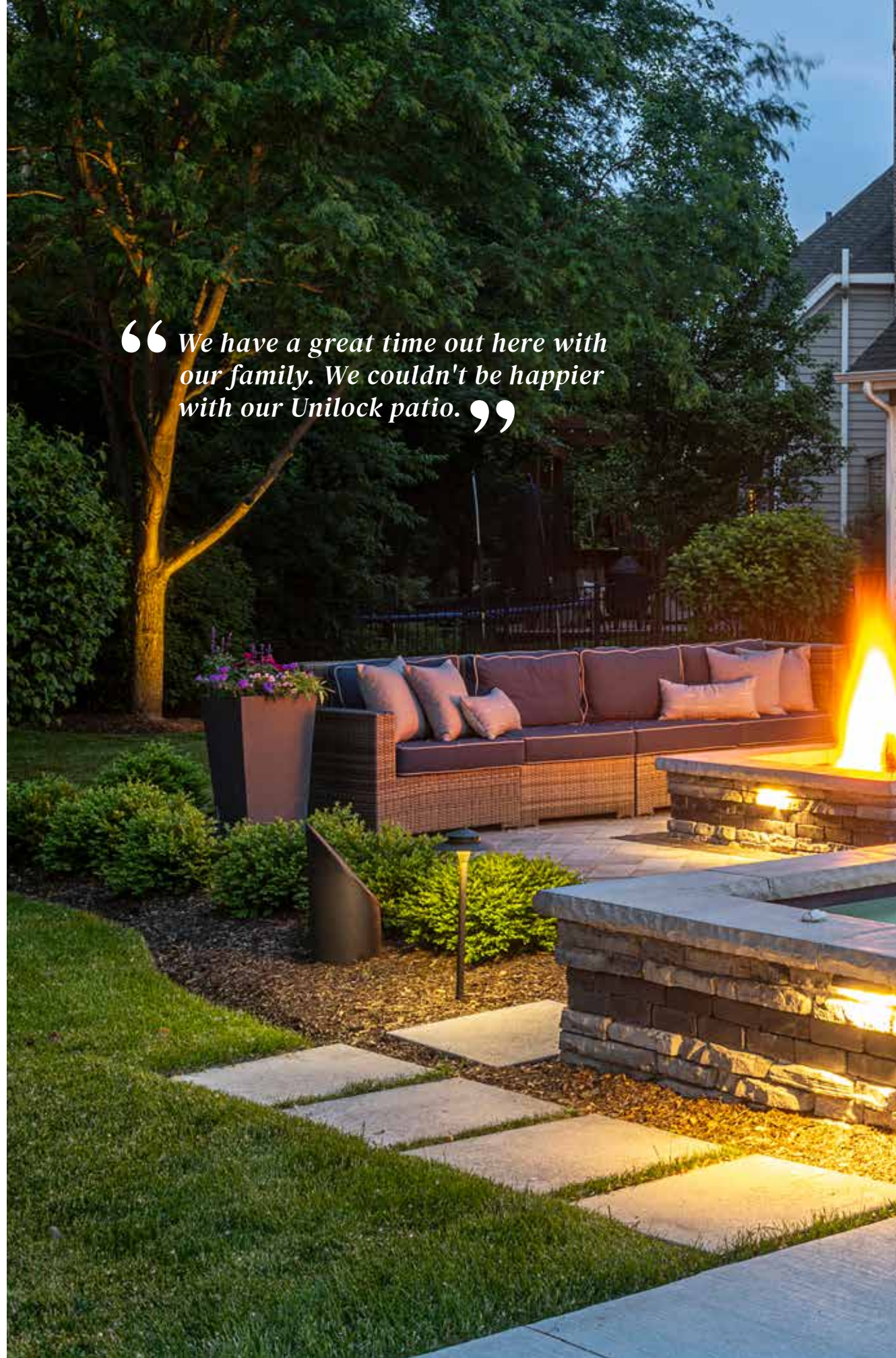



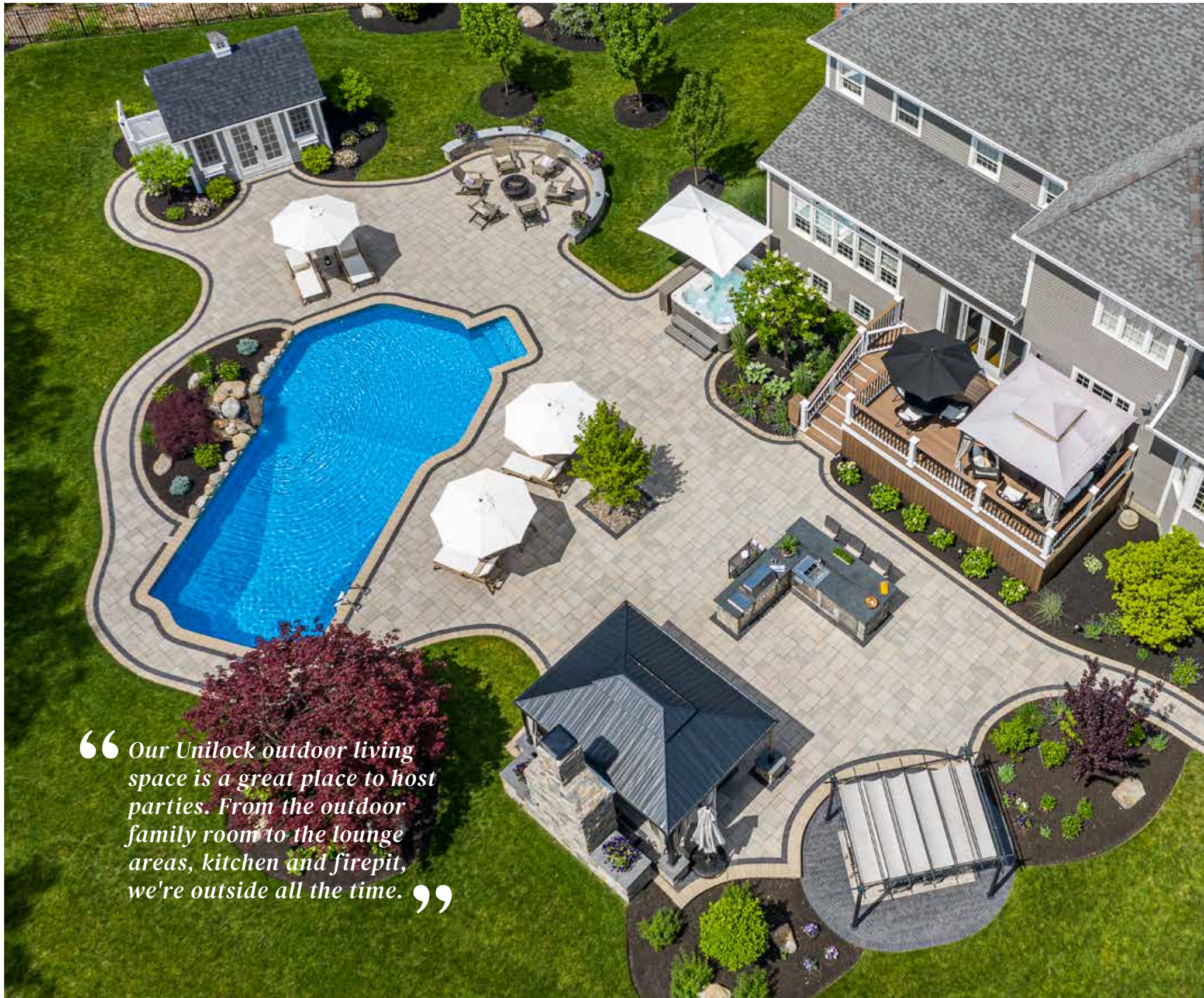

*“ Our Unilock outdoor living space is a great place to host parties. From the outdoor family room to the lounge areas, kitchen and firepit, we're outside all the time. ”*



With outdoor spaces designed for alfresco living, you'll gain a new appreciation for outdoor dining, relaxing, enjoying conversation in a peaceful environment and entertaining friends and family in style.

#### LEFT PAGE

**Pavers:** Beacon Hill™ Flagstone (Bavarian Blend) with Copthorne® (Basalt) and Brussels Block® (Sandstone) accents

#### TOP RIGHT

**Pavers:** Umbriano™ (Summer Wheat) with Town Hall® (Burnt Clay) accent and Natural Stone (Indian Coast) step

#### BOTTOM RIGHT

**Pavers:** Bristol Valley® (Steel Mountain) with Copthorne® (Basalt) and Brussels Block® (Sandstone) accent  
**Wall:** Brussels Dimensional Stone® (Sierra) with Copthorne (Basalt) accent and Ledgestone™ (Buff) coping



## EXPAND YOUR HOME

A new outdoor living space can add functional square footage to your existing home by providing a new space to relax and entertain. Consider first how you would like to use the space, and then design it as an extension of your interior decorating style. Even a small space can appear bigger by using different paver colors, paver borders, elevation changes and seat walls to define distinct areas for cooking, eating and relaxing.



**Pavers:** Beacon Hill Smooth (Bavarian Blend) with Mattoni™ (Dark Charcoal) accent  
**Walls:** Lineo™ Dimensional Stone (River) with Mattoni (Dark Charcoal) accent and LedgeStone™ (Buff) coping and trim detail



**Pavers:** Beacon Hill™ Smooth (Bavarian Blend) with Town Hall™ (Basalt) accent  
**Wall:** U-Cara™ (Bavarian Blend Pitched)



### *Did You Know?*

Unilock offers a software program that creates 3D visuals of your design. The software is called Uvision® 3D Landscape Creator and it's available to your contractor or designer.

## GET INSPIRED!

Fire features are growing in popularity because they add visual interest and warmth that makes the space more enjoyable to use in cooler weather. Lighting installed in gardens, low walls, steps and pillars will also help draw people outside in the evening and adds visual appeal that you can enjoy from inside your home. Snow-covered pillars and walls can make beautiful accents to your property in the winter months.



### TOP LEFT

**Pavers:** Beacon Hill™ Smooth (Granite Fusion) with Town Hall® (Basalt) accent

**Seat Wall:** U-Cara® (Granite Fusion Pitched) with U-Cara (Opal Smooth) accent and Universal Coping (Grey)

**Firepit:** U-Cara (Opal Smooth) with Universal Coping (Grey)

### BOTTOM LEFT

**Pavers:** Thornbury™ (Bavarian Blend) with Town Hall® (Basalt) accent

**Wall:** U-Cara (Bavarian Pitched) with Universal Coping (Tan)

### RIGHT PAGE

**Pavers:** Umbriano™ (Winter Marvel) with Umbriano (Midnight Sky) accent

**Wall:** Rivercrest® Wall (Coastal Slate) with Natural Stone (Black River) pillar caps and LedgeStone™ (Grey) steps



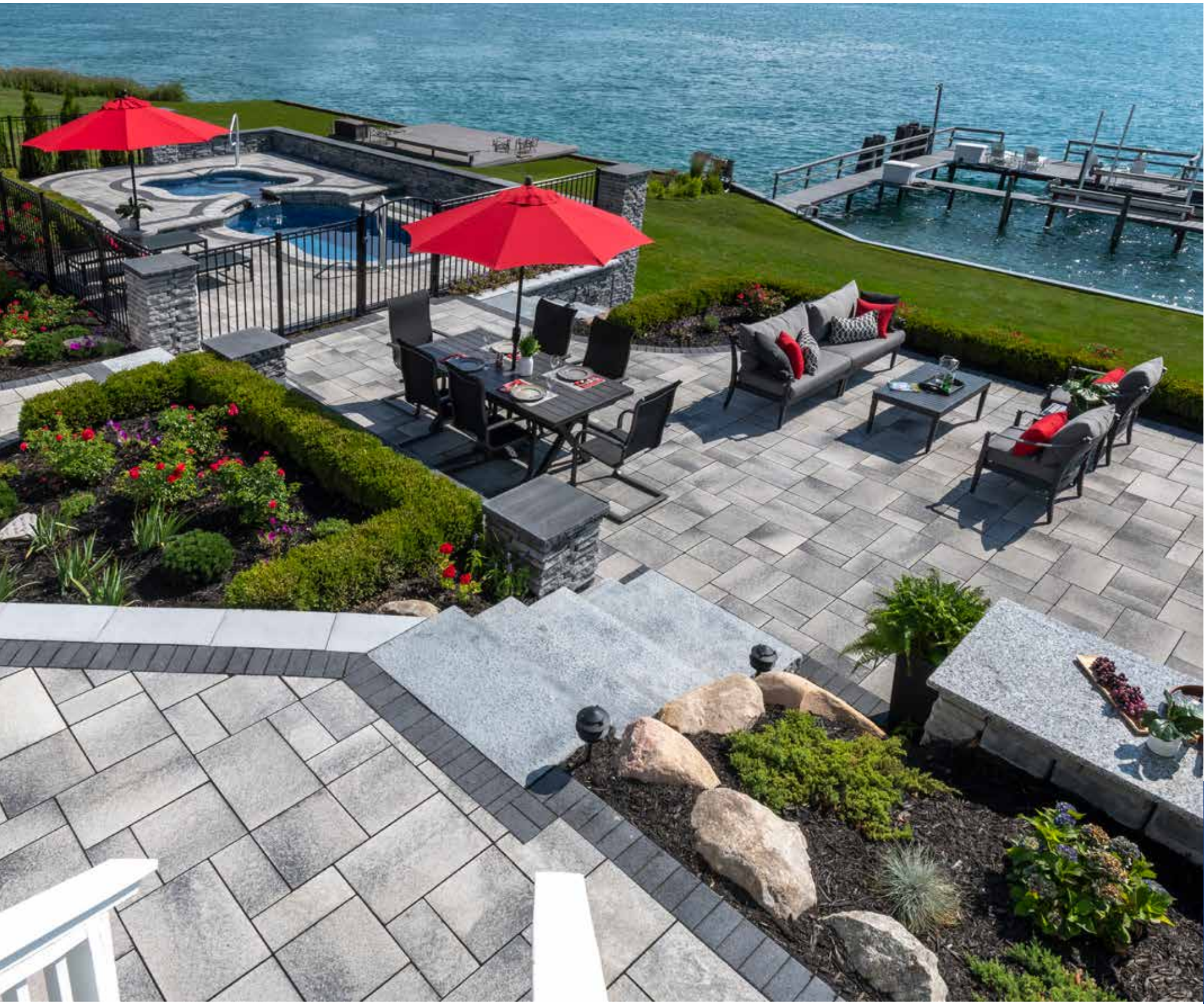



**BEST IN SHOW**

## Atlas Outdoor shows its strength in design and workmanship

2020 Best in Show Winner in the Unilock Awards of Excellence

This home was in the midst of construction when Sam Gembel, President of Atlas Outdoor, first met with the owners of this golf course-side property. During these early conversations he learned that the homeowners love to entertain, and that they didn't want any lawn to maintain in the approximately 5,500 sq. ft. backyard. This gave Atlas a very generous canvas to work with.



"There are no amenities missed in this job. It was a real honor, for sure."

*Sam Gembel*  
PRESIDENT OF ATLAS OUTDOOR





“When we were dreaming of our outdoor living space, we had two non-negotiables at the top of our list. We wanted it to be built to last, and we wanted to work with a local, reputable contractor. Unilock made it an easy choice with many products to choose from, and the Atlas Outdoor team brought it to life even better than we could have imagined!”

***Mike & Kathy***

HOMEOWNERS



Using Uvision 3D Landscape Creator from Unilock, the team created a captivating outdoor design complete with a fly-through video. “We were able to include every feature you could think of – even the kitchen sink,” Sam quipped.

“Getting to see the Uvision design gave us a better idea of how the space would lay out before the heavy machinery even showed up to start digging!” said the homeowner.

The stunning, multi-level design was constructed with Lineo verticals and Umbriano pavers. It contains numerous water elements, two fire features (a gas fire pit and a wood-burning fireplace) and a covered pavilion with a complete outdoor kitchen and bar, with smaller patios used to divide the large area into intimate “rooms.” LED lights add ambience and help ensure safe footing after dark.

In order to complete the project, the Atlas team was on site nearly every day for approximately four months.

However, they did experience an unusual job hazard...stray golf balls from the “very active fairway” behind the home. “We heard ‘fore!’ several times a day,” said Sam jokingly.

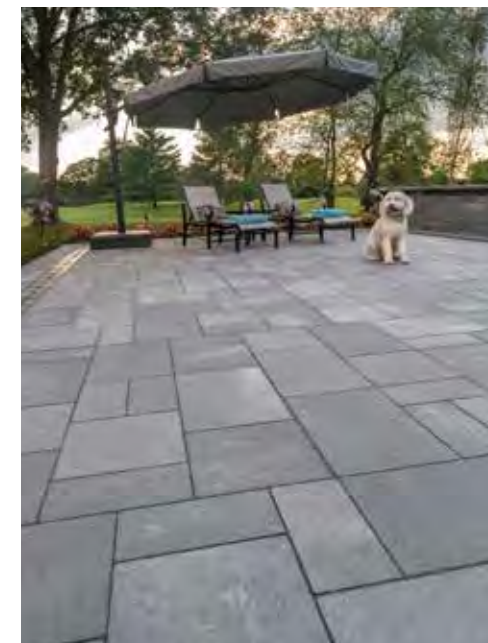

**Pavers:** Umbriano™ (French Grey) with Town Hall™ (Basalt) accent

**Wall:** Fire Feature, Water Feature and Outdoor Kitchen built with Lineo Dimensional Stone™ (Granite Blend)

**Steps & Coping:** Natural Stone

# Pool Decks

---

The beauty of a built-in swimming pool is trumped by the excitement of having it right in your own backyard! Here your imagination can run wild, with the addition of complementary pavers, slabs, borders, and vertical features to enhance and distinguish.

**Pavers:** Bristol Valley® (Steel Mountain) with Cophorne® (Basalt) and Brussels Block® (Sandstone) accents and Brussels Fullnose Coping (Sierra)  
**Wall:** Brussels Dimensional Stone® (Sierra) with Brussels Fullnose (Sierra) pool coping and Brussels Fullnose (Sandstone) coping and step treads





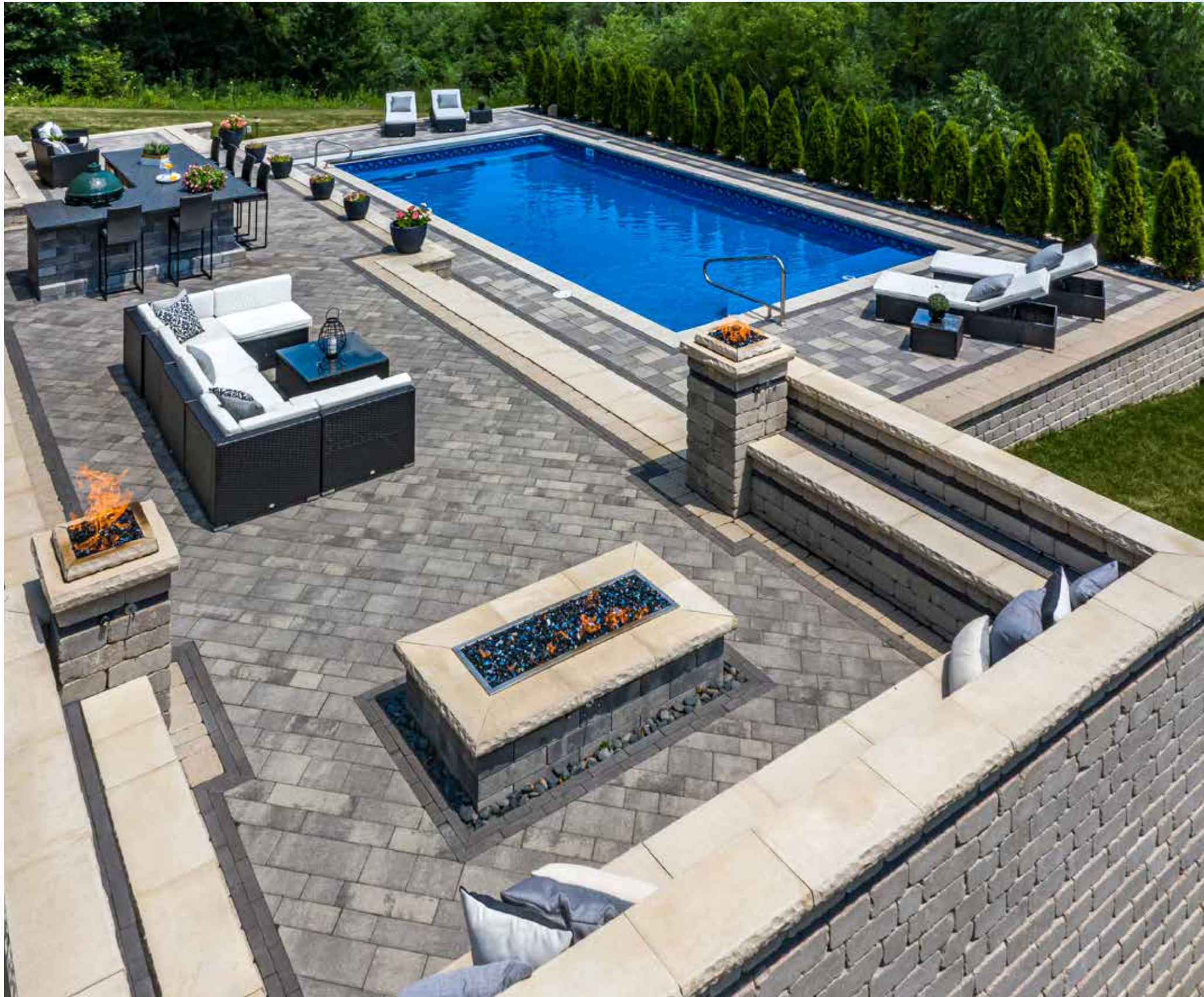



## SIZE MATTERS

When planning your pool deck, four feet is the minimum perimeter around the pool for basic access. However, if you intend to use the pool deck as a patio for entertaining or sunbathing, you'll need to increase this significantly. Be sure to keep in mind the size of your outdoor furniture; it's typically much bigger than indoor furniture!

### LEFT PAGE

**Upper Pavers:** Artline™ (Steel Mountain) and with Mattoni™ (Dark Charcoal) and Brussels Block® (Sandstone) accents

**Lower Pavers:** Westport™ (Granite) with Mattoni (Dark Charcoal) and Brussels Block (Sandstone) accents

**Walls:** Olde Quarry® (Sandstone) with Ledgestone™ (Buff) coping and pillar caps

### TOP RIGHT

**Paver:** Beacon Hill™ Smooth (Granite Fusion)

### BOTTOM RIGHT

**Water Feature:** U-Cara® (Granite Fusion Pitched) with Natural Stone (Stone Cliff Grey) coping



Naturally, the deck surrounding a pool not only enhances its elegance, it's also important for safety reasons.

### **SAFETY CONSIDERATIONS**

The paver you choose for your pool deck deserves special consideration because you'll be walking on it in your bare feet! Be sure to choose a color that won't absorb too much heat from the summer sun. A smoother surface is pleasing to walk on, but make sure it's sufficiently non-slip. Umbriano™ is our most popular choice for pool decks. For the coping around the edge of the pool, avoid products with abrasive edges. A contrasting coping color or inset border is also something to consider, as it helps define the pool edge.





**LEFT**

**Pavers:** Beacon Hill™ Flagstone (Bavarian Blend) with Mattoni™ (Cocoa Brown and Dark Charcoal) and Brussels Block® (Sandstone) accents

**Wall:** Rivercrest® Wall (Buff) with Ledgestone™ (Buff) coping and pillar caps

**RIGHT**

**Pavers:** Copthorne® (Steel Blue) with Copthorne (Basalt) accents and Umbriano™ (Winter Marvel)



# Driveways

---

There's nothing like the welcome you'll feel when you pull up to your Unilock driveway. A stunning paver driveway is an investment that adds instant curb appeal and value to your home. Your Unilock driveway will be strong, durable and designed to withstand heavy use throughout the year while looking beautiful for years to come!





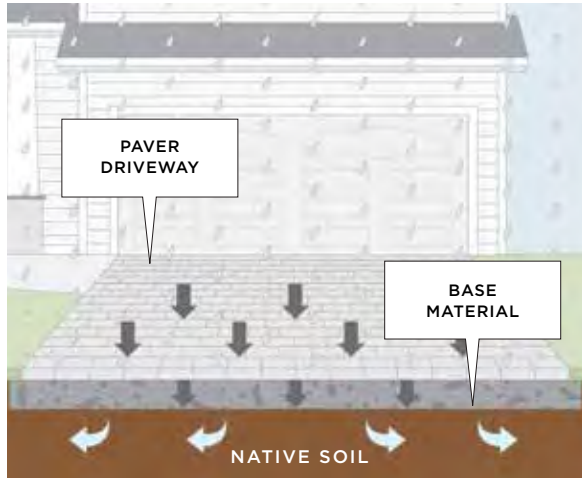

## THINK GREEN

Permeable pavers allow rainwater to flow between the joints, through base materials and into the subsoil below. This reduces puddling on the driveway surface when it rains, and reduces ice build-up in winter. It also provides a dual “green” benefit; not only does it reduce the amount of water that flows into storm sewers but it also provides moisture to surrounding plant material.



### TOP LEFT

**Paver:** Town Hall® (Basalt)

### BOTTOM LEFT

**Paver:** Thornbury™ (Bavarian) with Town Hall® (Basalt) accent

### RIGHT PAGE

**Paver:** Tribeca Cobble™ (Cobalt Grey) with Tribeca Cobble (Peppered Granite) accent and Cophorne (3 Color Blend) insert

*“ The Authorized Contractor  
that Unilock recommended  
was just outstanding! ”*



**LEFT PAGE**

Richcliff® (Dawn Mist) with Cophorne®  
(3 Color Blend) accent and apron

**TOP RIGHT**

Umbriano™ (Summer Wheat) with  
Courtstone® (Basalt) accent and driveway

**BOTTOM RIGHT**

Courtstone (Pebble Taupe and Dawn Mist) with  
Cophorne (3 Color Blend) accent



# Entrances & Walkways

---

A great looking front entrance gives guests a warm welcome. Attractive steps that are wide enough to easily navigate, low garden walls and planter boxes, and smartly placed lighting all contribute to a cozy feeling that smooths the transition from the street to your home.

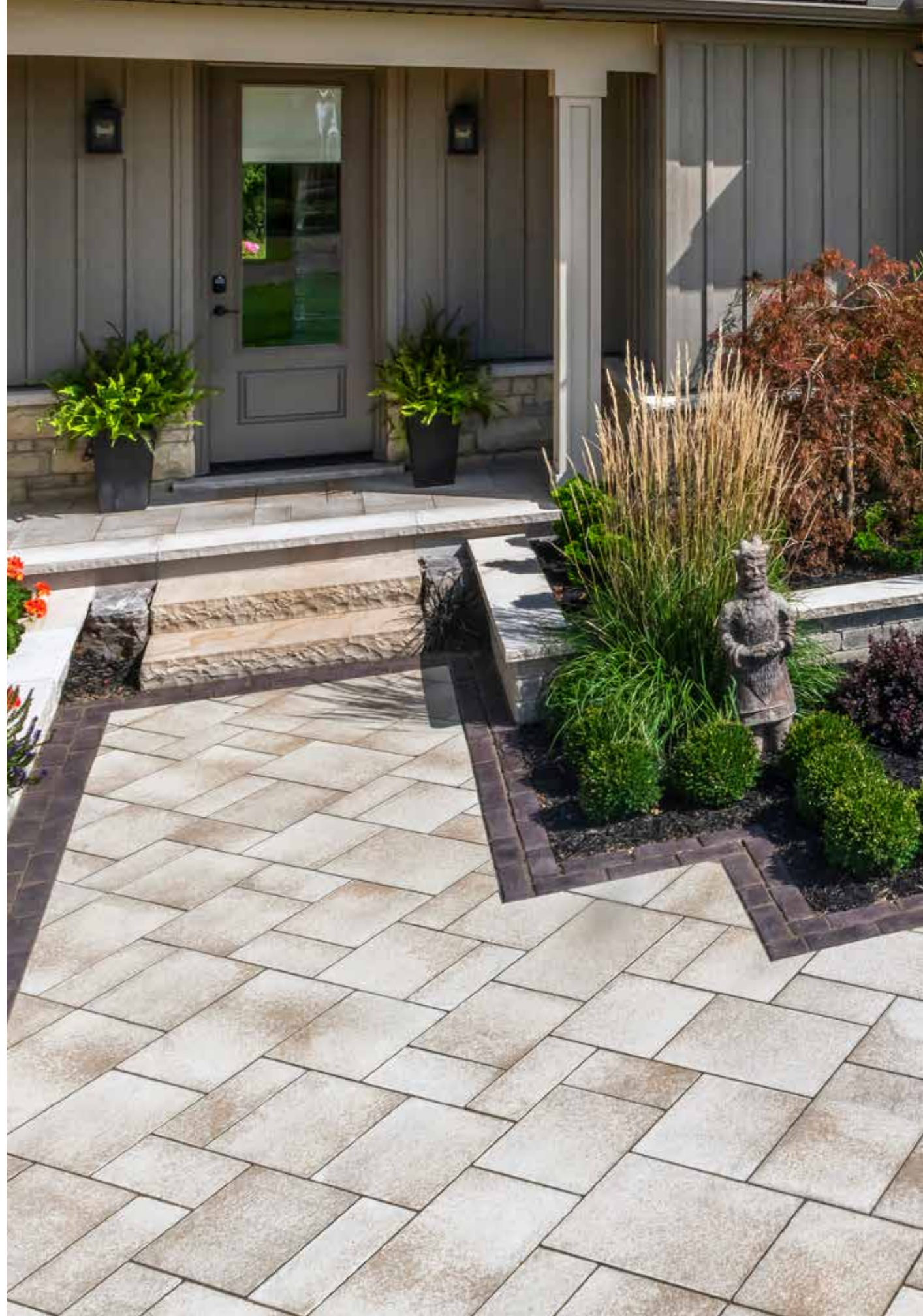

**Pavers:** Umbriano™ (Summer Wheat) with Town Hall® (Burnt Clay) accent







**Paver:** Copthorne® (3 Color Blend) accent

### *Did You Know?*

Unilock offers homeowners and contractors free samples so you can match our products to your home.

## **A PLACE TO SIT**

Even a modest front yard can usually accommodate a small seating space. Picture yourself enjoying your morning coffee or watching the kids playing as you proudly admire your beautiful Unilock entry.

**Pavers:** Richcliff® (Dawn Mist and Pebble Taupe) with Copthorne (3 Color Blend) accent





**Pavers:** Beacon Hill™ Smooth (Granite Fusion) with Copthorne (Basalt) accents  
**Steps:** Copthorne (Basalt) accent fascia with Ledgestone™ (Buff) step treads

*“Richcliff was the perfect choice for the front entrance of our lakeside home.”*

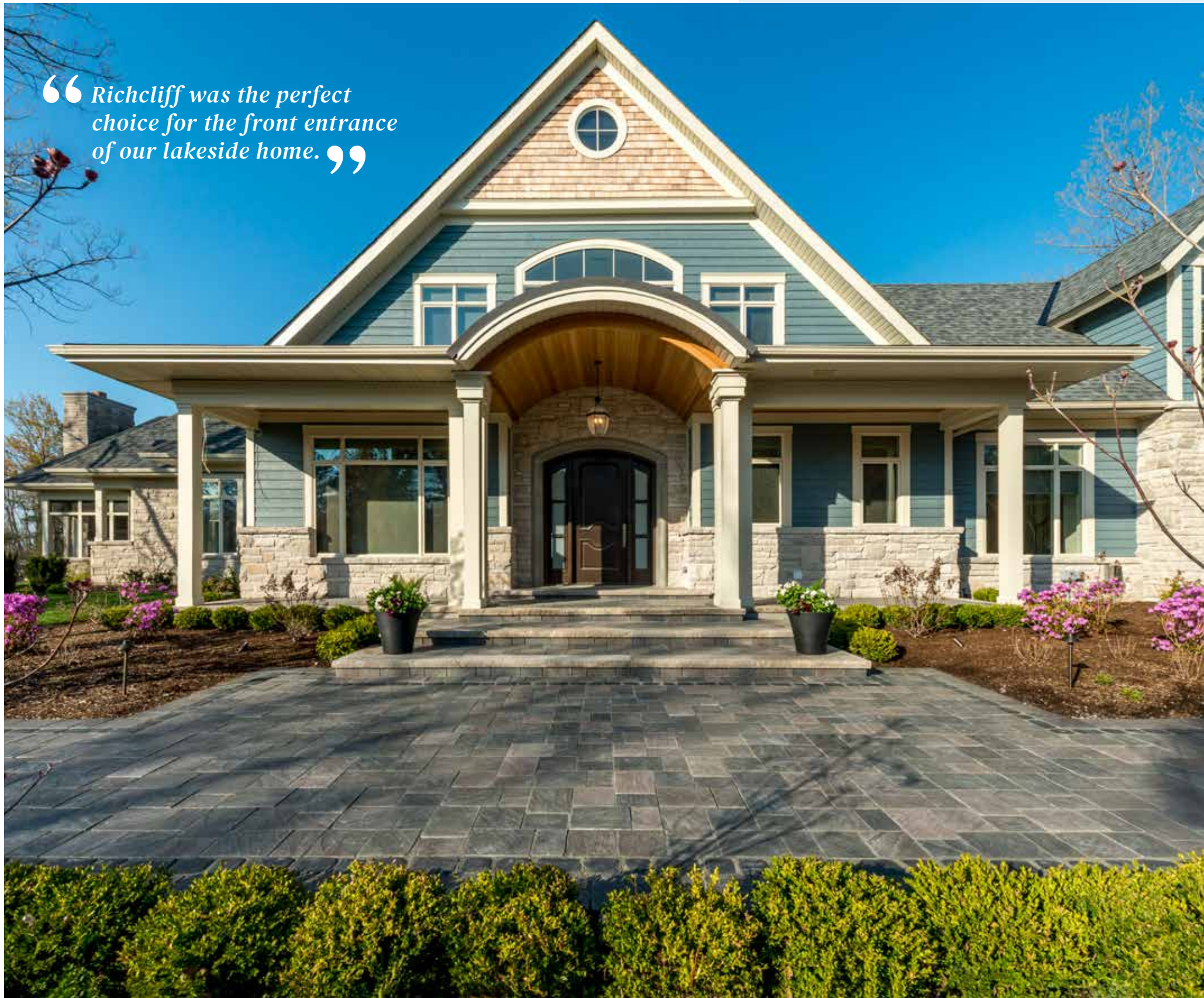



## COMPLEMENT YOUR HOME

The exterior of your home should set the stage for the design, textures and colors you choose. Consider replicating, augmenting or complementing the architectural features of your home.

### LEFT PAGE

**Pavers:** Richcliff® (Dawn Mist and Pebble Taupe) with Courtstone® (Basalt) accent

### TOP RIGHT

**Pavers:** Town Hall® (Heritage Red) with LedgeStone™ (Buff) step treads

### BOTTOM RIGHT

**Pavers:** Copthorne® (3 Color Blend) with Brussels Block® (Sandstone) paver rug accents  
**Wall:** Rivercrest® Wall (Buff) with LedgeStone (Buff) coping and pillar caps



# Urban Spaces

---

You can use any of our products to create unique Urban Spaces that work beautifully in diminutive yards. Improve your curb appeal with a stunning front entrance with or without a driveway and extend your living area outdoors. Unilock is the perfect solution for economical, functional and beautiful outdoor spaces no matter the size!

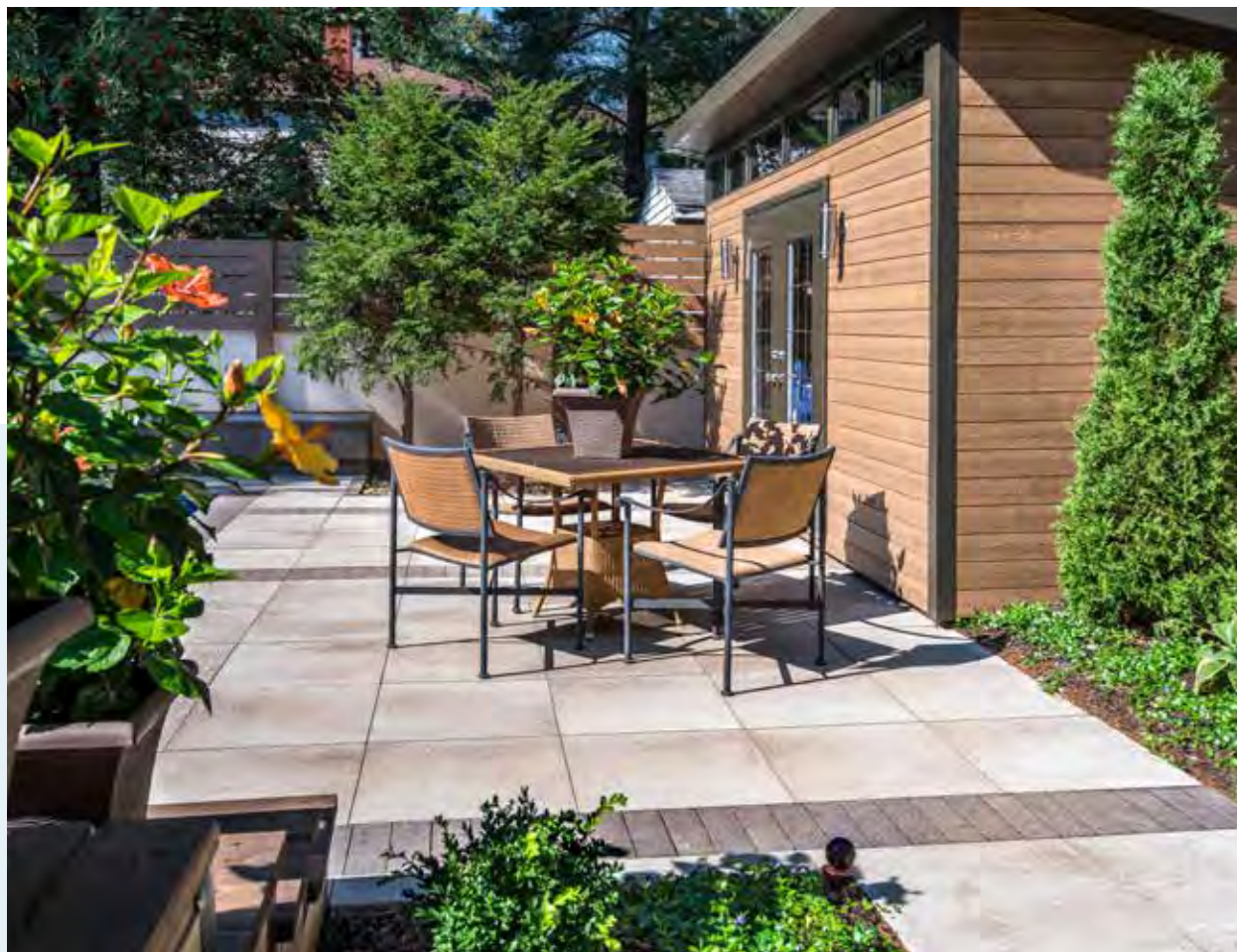

**TOP RIGHT**

**Paver:** Umbriano™ (Summer Wheat)

**BOTTOM RIGHT**

**Pavers:** Richcliff® (Dawn Mist) with  
Cophorne (Basalt) accent

**Grill Island:** Rivercrest® Wall (Coastal Slate)









### LOOK HERE!

The right focal point will add visual interest that will make your modestly-sized space feel more grand.

#### LEFT PAGE

**Paver:** Umbriano™ (French Grey)

#### TOP RIGHT

**Paver:** Natural Stone (Stone Cliff Grey)  
**Firepit:** Lineo™ Dimensional Stone (Granite Blend) with Ledgestone™ Fullnose (Buff) coping

#### BOTTOM RIGHT

**Pavers:** Beacon Hill™ Smooth (Granite Fusion) with Mattoni™ (Dark Charcoal) accent  
**Grill Island:** Lineo Dimensional Stone (Granite Blend) with Mattoni (Dark Charcoal) accent



Pavers  
Slabs  
Retaining Walls & Vertical Features  
Steps, Treads, Coping & Caps  
Making your Project Unique

# Products

*Unilock makes your landscape dreams come true  
with the highest quality products in the industry.*



# Unilock Product Categories

---

Unilock makes your landscape dreams come true with the highest quality pavers and walls in the industry. We offer five categories of products that are designed to offer you beauty, longevity and low maintenance. Whatever Unilock product you choose, we stand behind it 100%.

## *Did You Know?*

Unilock was the first company to bring EnduraColor technology to North America, more than 25 years ago.

## CLASSIC

Our budget-friendly, Unilock Classic pavers and walls are manufactured to exceed ASTM standards for quality and strength. Available in classic shapes and styles, these products utilize a traditional product mix of large and small aggregates that is consistent from top to bottom with color mixed throughout.



## ENDURACOLOR™

The refined surface of Unilock EnduraColor products is achieved with a two-step manufacturing process that combines a base of coarser aggregates for a stronger foundation with concentrated color and wear-resistant finer aggregates on top. This process protects the surface from the appearance of fading over time because the top layer prevents large, lighter color aggregates from ever showing through. Now, with U-Cara®, walls are available with EnduraColor too!

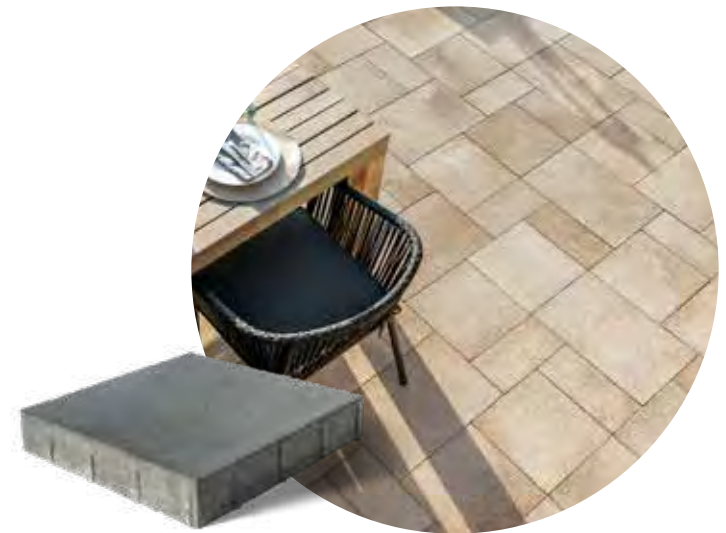

## ELEGANCE®

Deep, rich colors and a multitude of unique Reala™ textures combine to deliver the timeless beauty of Unilock Elegance. From the timeworn look of European cobblestones, to the classic luxury of riven natural stone slabs, our Elegance collection offers styles you can't get anywhere else. Thanks to Ultima™ Concrete, the look you purchase is the look that will last, with up to 4x the strength of poured-in-place concrete.





## STONEMARK™

The highly detailed surface texture of StoneMark products is created using Reala Technology. Combined with careful color blending, the result is surface texture and color variation resembling natural stone, but with the durability and precision of a manufactured paver or wall product.



## PERMEABLE

To reduce the amount of rainwater that flows off the surface of your new pavers and into storm sewers, consider a permeable paving system. Unilock permeable pavers have extra wide joint spaces and are installed on a special aggregate base so water flows through, replenishing the natural ecosystem.



# The Product is Roughly 20% of the Total Cost

**BUY THE BEST!**

The major cost of your project is the prep work and installation – not the cost of the product (the ratio is approximately 20% product 80% installation). Don't compromise! Choose the product you love, to get the maximum enjoyment from the investment you've made below the surface

### CONSTRUCTION CROSS SECTION

### PROJECT COST

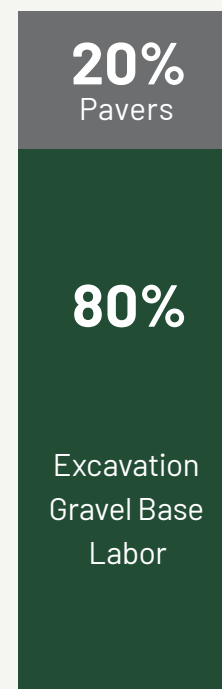

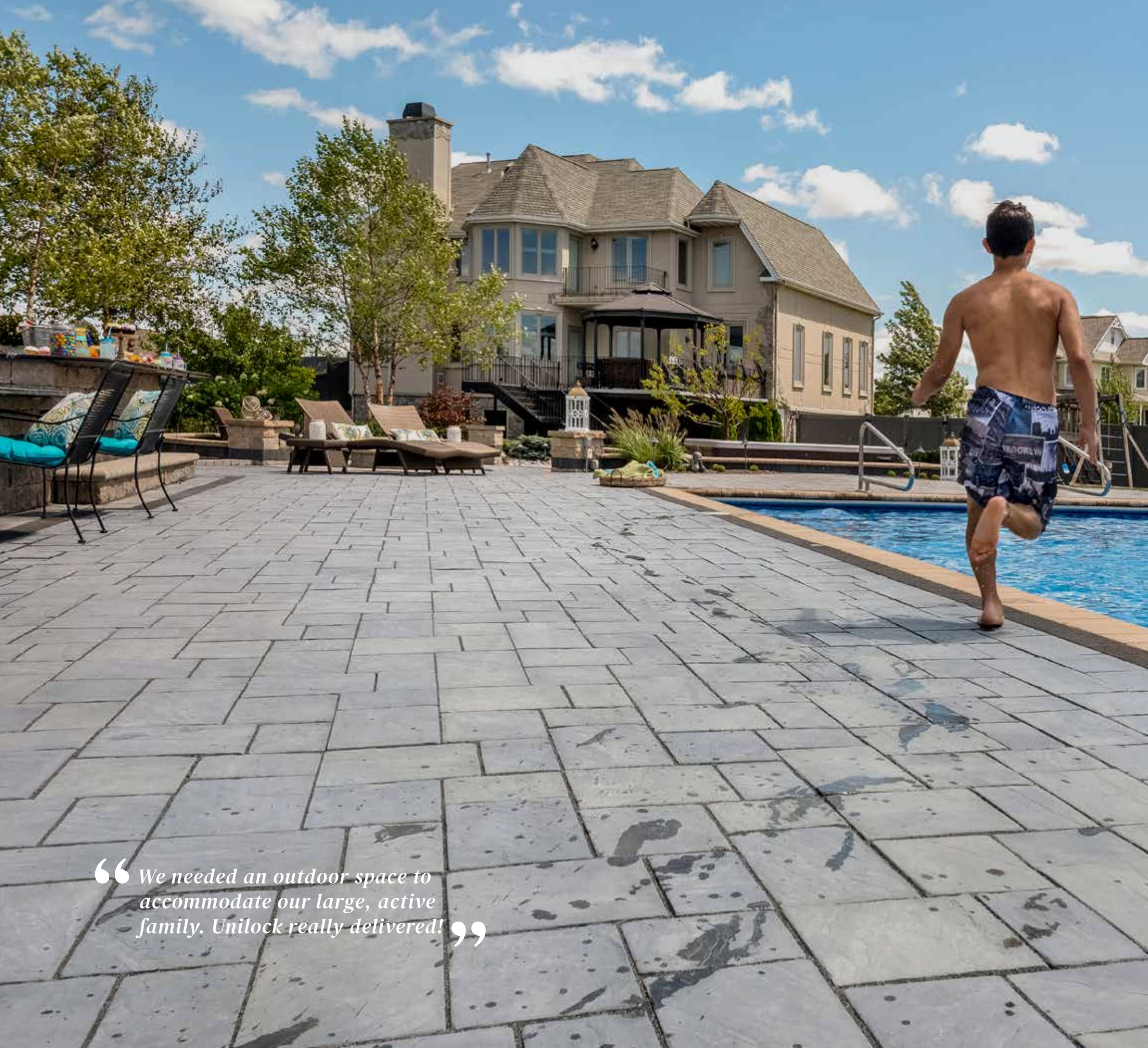

*“ We needed an outdoor space to accommodate our large, active family. Unilock really delivered! ”*



UNILOCK® COLLECTION OF

# Pavers & Slabs

From traditional shapes and textures to the most advanced technology and unique styles, the choices available in our paver collection are unrivaled in the industry.

Richcliff® (Dawn Mist) with Series™ (Onyx Black) accent and Brussels Fullnose™ (Sandstone) coping





**CLASSIC**

# Westport™

---

**ADVANTAGES**

**ClassicCoat**

Factory sealed to protect surface texture and color

**DRIVE FRIENDLY**

Can handle vehicular loads



**GRANITE**



**RIVER NEW**



**SIERRA**



**LARGE RECTANGLE**  
10 x 15 x 2¾"  
254 x 380 x 70mm



**SQUARE**  
10 x 10 x 2¾"  
254 x 254 x 70mm



**RECTANGLE**  
5 x 10 x 2¾"  
127 x 254 x 70mm



**RECTANGLE**  
5 x 10 x 2¾"  
127 x 254 x 70mm

3 UNIT RANDOM BUNDLE

Sierra with Series™ (Onyx Black) accent



## CLASSIC

# Brussels Block<sup>®</sup>

### ADVANTAGES

#### ANTIQUED FINISH

Distressed, timeworn finish

#### DRIVE FRIENDLY

Can handle vehicular loads



**COFFEE CREEK**



**LIMESTONE** NOT AVAILABLE IN COPING



**RIVER** NOT AVAILABLE IN COPING



**SANDSTONE**



**SIERRA**



**XL STONE**  
8<sup>1</sup>/<sub>4</sub> x 13<sup>3</sup>/<sub>4</sub> x 2<sup>3</sup>/<sub>4</sub>"  
208 x 348 x 70mm



**STANDARD STONE**  
6<sup>7</sup>/<sub>8</sub> x 8<sup>1</sup>/<sub>4</sub> x 2<sup>3</sup>/<sub>4</sub>"  
173 x 208 x 70mm



**HALF STONE**  
4<sup>1</sup>/<sub>8</sub> x 6<sup>7</sup>/<sub>8</sub> x 2<sup>3</sup>/<sub>4</sub>"  
104 x 173 x 70mm



**FULLNOSE COPING**  
6 x 12 x 2<sup>3</sup>/<sub>4</sub>"  
150 x 300 x 70mm

Non-antiqued coping also available see page 137.

Sierra with Courtstone<sup>®</sup> (Basalt) accent



## CLASSIC

# Olde Greenwich Cobble™

---

### ADVANTAGES

#### DRIVE FRIENDLY

Can handle vehicular loads



**AUTUMN RED**



**RIVER**



**SIERRA**



#### **MEDIUM RECTANGLE**

4<sup>3</sup>/<sub>4</sub> x 7 x 2<sup>3</sup>/<sub>8</sub>"

120 x 180 x 60mm

Autumn Red and Sierra Mix with Brussels Block® (Sandstone) accent

## CLASSIC

# Hollandstone™

### ADVANTAGES

#### DRIVE FRIENDLY

Can handle vehicular loads



**AUTUMN RED**



**CHARCOAL**



**RIVER**



**RUSTIC RED**



**SIERRA**



**STANDARD**  
4 x 8 x 2<sup>3</sup>/<sub>8</sub>"  
100 x 200 x 60mm

Sierra with Copthorne® (3 Color Blend) accent



## CLASSIC

# Eco-Priora™

---

### ADVANTAGES

#### PERMEABLE

Can be installed to allow water to flow through

#### DRIVE FRIENDLY

Can handle vehicular loads



RIVER



SIERRA



#### RECTANGLE

5 x 10 x 3 1/8"

120 x 240 x 80mm

River

**ENDURACOLOR™**

*Refined surface and  
long-lasting color*

## Eco-Priora™

### ADVANTAGES

#### PERMEABLE

Can be installed to allow  
water to flow through

#### DRIVE FRIENDLY

Can handle vehicular loads



**SABLE BLEND**



**GRANITE NEW**



#### RECTANGLE

5 x 10 x 3 1/8"  
120 x 240 x 80mm

Granite





**ENDURACOLOR™***Refined surface and  
long-lasting color*

# Holland Premier™

## ADVANTAGES

### DRIVE FRIENDLY

Can handle vehicular loads



**CHARLESTON**

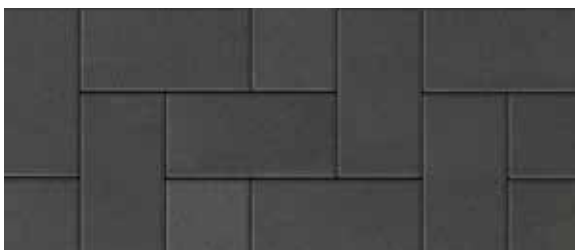

**DARK CHARCOAL** NEW



**GRANITE BLEND**



**HERITAGE BROWN**



**RIVER**



**SIERRA**



**STANDARD**  
4 x 8 x 2<sup>3</sup>/<sub>8</sub>"  
100 x 200 x 60mm

Charleston



**ENDURACOLOR™***Refined surface and  
long-lasting color*

# Brussels Premier™

## ADVANTAGES

### ANTIQUED FINISH

Distressed, timeworn finish

### DRIVE FRIENDLY

Can handle vehicular loads



**ALPINE GREY**



**BAVARIAN BLEND**



**SYCAMORE**



### **XL STONE**

8¼ x 13¾ x 2¾"  
208 x 348 x 70mm



### **STANDARD STONE**

6⅞ x 8¼ x 2¾"  
175 x 208 x 70mm



### **HALF STONE**

4⅞ x 6⅞ x 2¾"  
104 x 175 x 70mm

Bavarian Blend and Sycamore (Blended on Site) with Cophorne® (Basalt) accent



**ENDURACOLOR™***Refined surface and  
long-lasting color*

# Thornbury™

## ADVANTAGES

### PERMEABLE

Can be installed to allow  
water to flow through

### DRIVE FRIENDLY

Can handle vehicular loads

**ALPINE GREY****BAVARIAN BLEND****FOSSIL****LARGE RECTANGLE**  
13<sup>3</sup>/<sub>4</sub> x 16<sup>1</sup>/<sub>2</sub> x 2<sup>3</sup>/<sub>4</sub>"  
350 x 420 x 70mm**MEDIUM RECTANGLE**  
13<sup>1</sup>/<sub>2</sub> x 8<sup>1</sup>/<sub>4</sub> x 2<sup>3</sup>/<sub>4</sub>"  
350 x 210 x 70mm**SMALL RECTANGLE**  
6<sup>7</sup>/<sub>8</sub> x 8<sup>1</sup>/<sub>4</sub> x 2<sup>3</sup>/<sub>4</sub>"  
173 x 210 x 70mm**3 UNIT RANDOM BUNDLE**

Bavarian Blend with Town Hall® (Basalt) accent



**ENDURACOLOR™***Refined surface and  
long-lasting color*

# Treo® Smooth

## New

**ADVANTAGES****PERMEABLE**

Can be installed to allow water to flow through

**DRIVE FRIENDLY**

Can handle vehicular loads

**GRANITE****RIVER****SIERRA**

**LARGE RECTANGLE**  
 $8\frac{7}{8} \times 13\frac{1}{4} \times 2\frac{3}{8}$ "  
 225 x 338 x 60mm



**SQUARE**  
 $8\frac{7}{8} \times 8\frac{7}{8} \times 2\frac{3}{8}$ "  
 225 x 225 x 60mm



**SMALL RECTANGLE**  
 $4\frac{1}{2} \times 8\frac{7}{8} \times 2\frac{3}{8}$ "  
 112 x 225 x 60mm

3 UNIT RANDOM BUNDLE

**Pavers:** Granite with Holland Premier™ (Dark Charcoal) accent  
**Wall:** Estate Wall™ (Granite) with Universal Coping (Grey)





**ENDURACOLOR™***Refined surface and  
long-lasting color*

# Beacon Hill™ Flagstone

## 60 mm

### ADVANTAGES

#### PEDESTRIAN FRIENDLY

Not recommended for vehicular

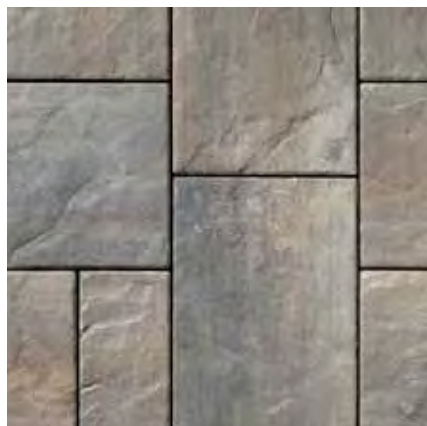
**ALPINE GREY****BAVARIAN BLEND****FOSSIL****OAKWOOD NEW****LARGE RECTANGLE**  
14 x 21 x 2<sup>3</sup>/<sub>8</sub>"  
360 x 540 x 60mm**SQUARE**  
14 x 14 x 2<sup>3</sup>/<sub>8</sub>"  
360 x 360 x 60mm**SMALL RECTANGLE**  
7 x 14 x 2<sup>3</sup>/<sub>8</sub>"  
180 x 360 x 60mm**XL UNIT**  
21 x 35 x 2<sup>3</sup>/<sub>8</sub>"  
540 x 890 x 60mm**3 UNIT RANDOM BUNDLE****Pavers:** Alpine Grey with Mattoni™ (Dark Charcoal) accent**Wall:** Brussels Dimensional Stone™ (Sandstone) with Town Hall™ (Basalt) accent and Ledgestone™ (Buff) coping and steps



**ENDURACOLOR™***Refined surface and  
long-lasting color*

# Beacon Hill™ Flagstone

## 80 mm

**ADVANTAGES****DRIVE FRIENDLY**

Can handle vehicular loads

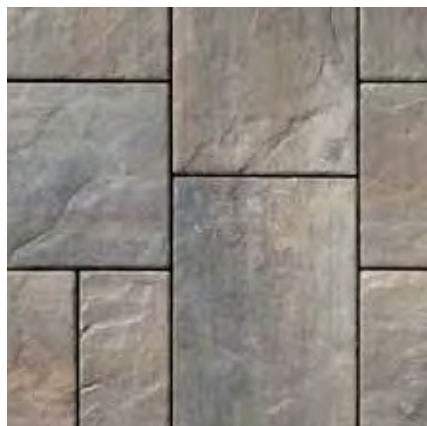
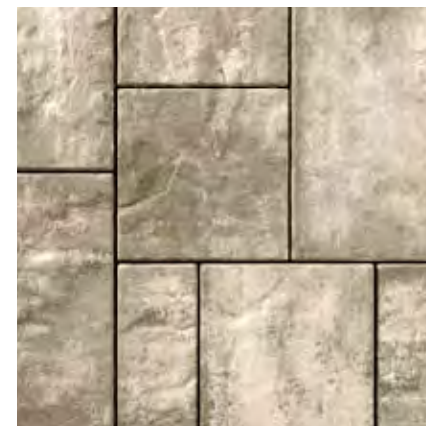
**ALPINE GREY****BAVARIAN BLEND****FOSSIL****OAKWOOD NEW**

**LARGE RECTANGLE**  
14 x 21 x 3 1/8"  
360 x 540 x 80mm



**SQUARE**  
14 x 14 x 3 1/8"  
360 x 360 x 80mm



**SMALL RECTANGLE**  
7 x 14 x 3 1/8"  
180 x 360 x 80mm

3 UNIT RANDOM BUNDLE

Bavarian Blend with Series™ (Onyx Black) accent



**ENDURACOLOR™**

*Refined surface and  
long-lasting color*

# Beacon Hill™ Smooth

## ADVANTAGES

### PEDESTRIAN FRIENDLY

Not recommended for vehicular



**BAVARIAN**



**FOSSIL**



**GRANITE FUSION**



**OPAL**



**LARGE RECTANGLE**  
15 x 22½ x 2⅜"  
380 x 570 x 60mm



**SQUARE**  
15 x 15 x 2⅜"  
380 x 380 x 60mm



**SMALL RECTANGLE**  
7½ x 15 x 2⅜"  
190 x 380 x 60mm

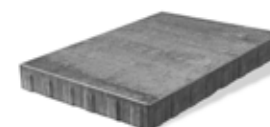

**XL UNIT**  
22½ x 37⅜ x 2⅜"  
570 x 950 x 60mm

3 UNIT RANDOM BUNDLE

**Pavers:** Bavarian Blend with Copthorne® (Basalt) accent

**Wall:** U-Cara® (Pitched Bavarian Blend) with LedgeStone™ (Buff) coping



**ENDURACOLOR™***Refined surface and  
long-lasting color*

# Bristol Valley®

Exclusive to **UNILOCK****ADVANTAGES** **EasyClean™**Factory sealed to provide integral  
surface protection from stains**PEDESTRIAN FRIENDLY**

Not recommended for vehicular

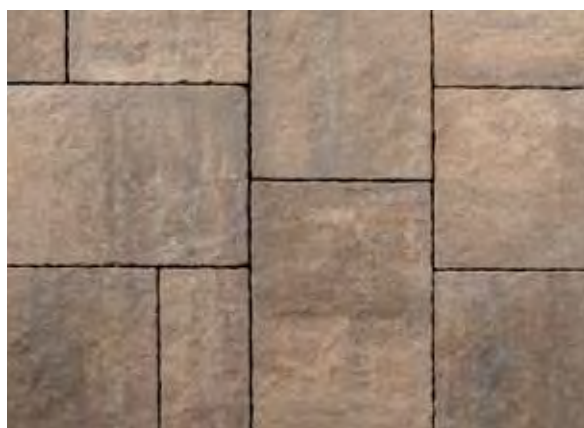
**BAVARIAN BLEND****FOSSIL NEW****STEEL MOUNTAIN****LARGE RECTANGLE**  
14 x 21 x 2<sup>3</sup>/<sub>8</sub>"  
360 x 540 x 60mm**SQUARE**  
14 x 14 x 2<sup>3</sup>/<sub>8</sub>"  
360 x 360 x 60mm**SMALL RECTANGLE**  
7 x 14 x 2<sup>3</sup>/<sub>8</sub>"  
180 x 360 x 60mm**XL UNIT**  
21 x 35 x 2<sup>3</sup>/<sub>8</sub>"  
540 x 890 x 60mm**3 UNIT RANDOM BUNDLE***8 mm Standard also available by Special Order.*

Steel Mountain with Copthorne® (Basalt) and Brussels Block® (Sandstone) accents





**ENDURACOLOR™***Refined surface and  
long-lasting color*

# Mattoni™

Exclusive to **UNILOCK**

## ADVANTAGES

### ANTIQUED FINISH

Distressed, timeworn finish

### DRIVE FRIENDLY

Can handle vehicular loads

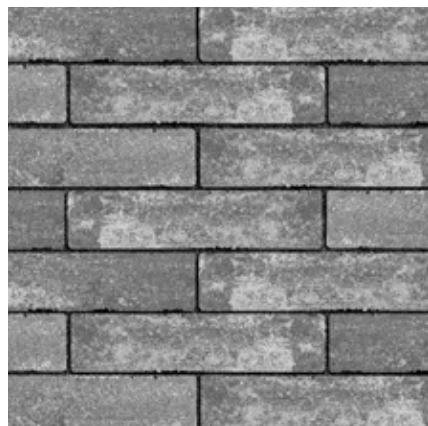
**COCOA BROWN****GRANITE FUSION NEW****SABLE BLEND****DARK CHARCOAL**

2¼ x 9½ x 2¾"  
60 x 240 x 70mm

Sable Blend with Cocoa Brown, Dark Charcoal and Brussels Block® (Sandstone) accents



**ENDURACOLOR™***Refined surface and  
long-lasting color*

# Artline™ SMOOTH FINISH

## ADVANTAGES



Factory sealed to provide integral surface protection from stains

## PEDESTRIAN FRIENDLY

Not recommended for vehicular

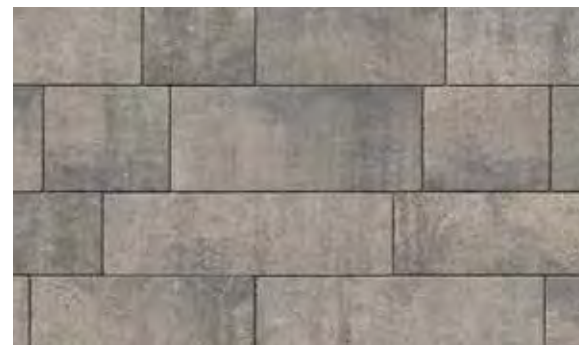
**BAVARIAN BLEND****FOSSIL****STEEL MOUNTAIN**

$7\frac{1}{2} \times 8\frac{7}{8} \times 2\frac{3}{4}$ "  
188 x 225 x 70mm



$7\frac{1}{2} \times 13\frac{3}{8} \times 2\frac{3}{4}$ "  
188 x 338 x 70mm



$7\frac{1}{2} \times 17\frac{3}{4} \times 2\frac{3}{4}$ "  
188 x 450 x 70mm



$4\frac{7}{8} \times 6\frac{3}{4} \times 2\frac{3}{4}$ "  
125 x 169 x 70mm



$4\frac{7}{8} \times 10\frac{3}{8} \times 2\frac{3}{4}$ "  
125 x 263 x 70mm



$4\frac{7}{8} \times 13\frac{3}{8} \times 2\frac{3}{4}$ "  
125 x 338 x 70mm



$4\frac{7}{8} \times 17\frac{3}{4} \times 2\frac{3}{4}$ "  
125 x 450 x 70mm

**7 UNIT RANDOM BUNDLE**

Steel Mountain



**ENDURACOLOR™***Refined surface and  
long-lasting color*

# Artline™ UMBRIANO™ FINISH

Exclusive to **UNILOCK****ADVANTAGES**

Factory sealed to provide integral surface protection from stains

**COLORFUSION™**

Subtly mottled color finish

**DRIVE FRIENDLY**

Can handle vehicular loads

**MIDNIGHT SKY****WINTER MARVEL** $7\frac{1}{2} \times 8\frac{7}{8} \times 2\frac{3}{4}$ "  
188 x 225 x 70mm $7\frac{1}{2} \times 13\frac{3}{8} \times 2\frac{3}{4}$ "  
188 x 338 x 70mm $7\frac{1}{2} \times 17\frac{3}{4} \times 2\frac{3}{4}$ "  
188 x 450 x 70mm $4\frac{7}{8} \times 6\frac{3}{4} \times 2\frac{3}{4}$ "  
125 x 169 x 70mm $4\frac{7}{8} \times 10\frac{3}{8} \times 2\frac{3}{4}$ "  
125 x 263 x 70mm $4\frac{7}{8} \times 13\frac{3}{8} \times 2\frac{3}{4}$ "  
125 x 338 x 70mm $4\frac{7}{8} \times 17\frac{3}{4} \times 2\frac{3}{4}$ "  
125 x 450 x 70mm**7 UNIT RANDOM BUNDLE**

Midnight Sky and Winter Marvel (Blended on Site)



**ENDURACOLOR™***Refined surface and  
long-lasting color*

# Artline™ IL CAMPO® FINISH

Exclusive to **UNILOCK****ADVANTAGES****BRUSHED FINISH**

Graphically interesting etched lines

**DRIVE FRIENDLY**

Can handle vehicular loads

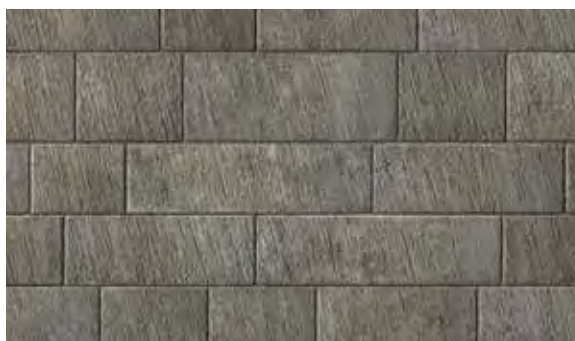
**BAVARIAN BLEND****GRANITE BLEND**
 $7\frac{1}{2} \times 8\frac{7}{8} \times 2\frac{3}{4}$ "  
188 x 225 x 70mm

 $7\frac{1}{2} \times 13\frac{3}{8} \times 2\frac{3}{4}$ "  
188 x 338 x 70mm

 $7\frac{1}{2} \times 17\frac{3}{4} \times 2\frac{3}{4}$ "  
188 x 450 x 70mm

 $4\frac{7}{8} \times 6\frac{3}{4} \times 2\frac{3}{4}$ "  
125 x 169 x 70mm

 $4\frac{7}{8} \times 10\frac{3}{8} \times 2\frac{3}{4}$ "  
125 x 263 x 70mm

 $4\frac{7}{8} \times 13\frac{3}{8} \times 2\frac{3}{4}$ "  
125 x 338 x 70mm

 $4\frac{7}{8} \times 17\frac{3}{4} \times 2\frac{3}{4}$ "  
125 x 450 x 70mm
**7 UNIT RANDOM BUNDLE**

Granite Blend Il Campo Finish with Steel Mountain Smooth Finish (Blended on Site) and Series™ (Onyx Black) accent



**LEFT**  
**Series banding idea for paver**  
Artline™ (Steel Mountain) with  
Onyx Black accent

**RIGHT**  
**Series banding idea for wall**  
Lineo Dimensional Stone (Granite Blend)  
with Onyx Black accent and Ledgestone™  
(Grey) coping and pillar cap

**BOTTOM**  
Cobalt Grey  
3 Unit Random Bundle

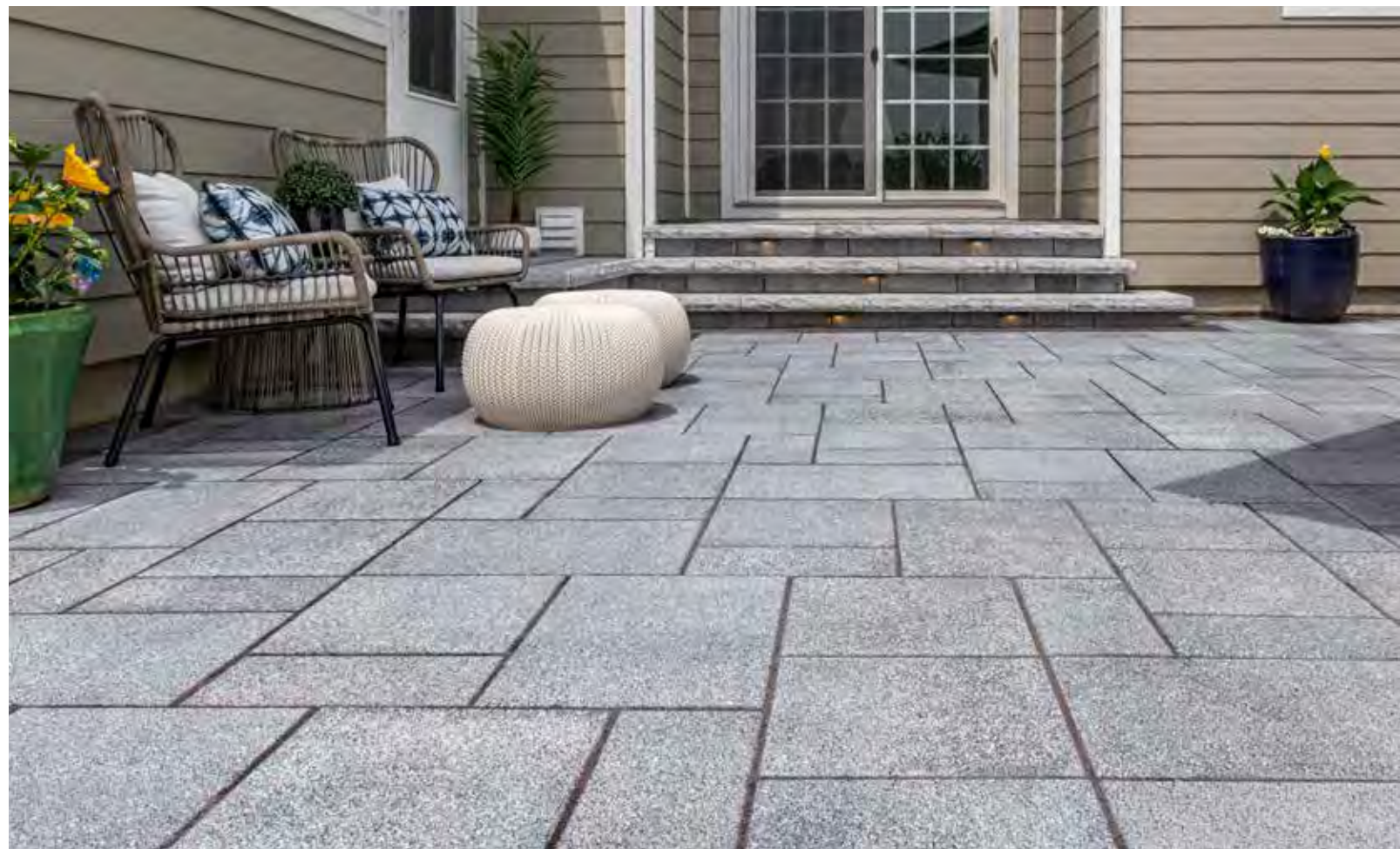



**ENDURACOLOR™***Refined surface and  
long-lasting color*

# Series™

## ADVANTAGES

Granite, Quartz and Marble surface materials

### DRIVE FRIENDLY

Random Bundle not recommended for vehicular  
All other sizes can handle vehicular loads

## 60mm

**COBALT GREY****AUTUMN GRANITE**

### 3 UNIT RANDOM BUNDLE

**LARGE RECTANGLE**  
14 x 21 x 2<sup>3</sup>/<sub>8</sub>"  
360 x 540 x 60mm**SQUARE**  
14 x 14 x 2<sup>3</sup>/<sub>8</sub>"  
360 x 360 x 60mm**SMALL RECTANGLE**  
7 x 14 x 2<sup>3</sup>/<sub>8</sub>"  
180 x 360 x 60mm

## 70mm

**ONYX BLACK****GOLDEN TAN**4 x 8 x 2<sup>3</sup>/<sub>4</sub>"  
100 x 200 x 70mm

## 80mm

**ARCTIC GREY****NORDIC STAR**4 x 12 x 3<sup>1</sup>/<sub>8</sub>"  
100 x 300 x 80mm



**ENDURACOLOR™**

*Refined surface and  
long-lasting color*

# Granito™

Exclusive to **UNILOCK**

## ADVANTAGES



Factory sealed to provide integral surface protection from stains

### ARTISTA™

Boldly mottled color finish

### DRIVE FRIENDLY

Can handle vehicular loads



**NOTTE**



**SABIA**



**HEX**  
8 x 8 x 2¾"  
200 x 200 x 70mm

**Pavers:** Notte and Sabia (Blended on Site)  
**Wall:** U-Cara® Granite Fusion (Smooth)

**ENDURACOLOR™***Refined surface and  
long-lasting color*

# Tribeca Cobble™

## ADVANTAGES

Granite, Quartz and Marble surface materials

### PERMEABLE

Can be installed to allow water to flow through

### DRIVE FRIENDLY

Can handle vehicular loads

**COBALT GREY****PEPPERED GRANITE****LARGE RECTANGLE**

5 1/8 x 12 x 2 3/4"  
130 x 305 x 70mm

**MEDIUM RECTANGLE**

5 1/8 x 9 x 2 3/4"  
130 x 230 x 70mm

**SMALL RECTANGLE**

5 1/8 x 7 x 2 3/4"  
130 x 175 x 70mm

**3 UNIT RANDOM BUNDLE**

Cobalt Grey



**ENDURACOLOR™**

*Refined surface and long-lasting color*

# Umbriano™

Exclusive to **UNILOCK**

## ADVANTAGES



Factory sealed to provide integral surface protection from stains

### COLORFUSION™

Subtly mottled color finish

### PEDESTRIAN FRIENDLY

Not recommended for vehicular



**NEW**  
4 x 12 x 4"  
100 x 300 x 100mm  
French Grey, Midnight Sky & Winter Marvel only



**PERMEABLE**   
3 x 12 x 4"  
80 x 300 x 100mm  
SPECIAL ORDER



4 x 8 x 2 3/8"  
100 x 200 x 60mm  
Midnight Sky only

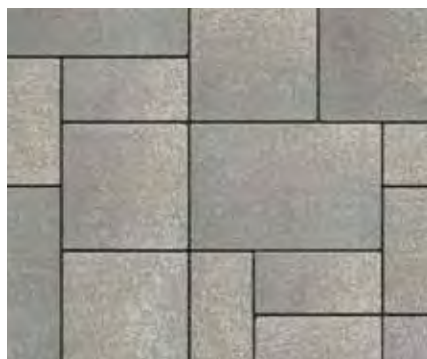

**FRENCH GREY**



**SUMMER WHEAT**



**WINTER MARVEL**



**MIDNIGHT SKY**



**LARGE RECTANGLE**  
15 x 22 1/2 x 2 3/8"  
380 x 570 x 60mm



**SQUARE**  
15 x 15 x 2 3/8"  
380 x 380 x 60mm



**SMALL RECTANGLE**  
7 1/2 x 15 x 2 3/8"  
190 x 380 x 60mm



**XL UNIT**  
22 1/2 x 37 3/8 x 2 3/8"  
570 x 950 x 60mm

3 UNIT RANDOM BUNDLE

Summer Wheat with Town Hall® (Burnt Clay) accent



**ENDURACOLOR™***Refined surface and  
long-lasting color*

# Arcana™

Exclusive to **UNILOCK**

## ADVANTAGES

Enhanced surface appearance

Factory sealed to provide integral  
surface protection from stains

## PEDESTRIAN FRIENDLY

Not recommended for vehicular

**CORVARA****LUGANO****MODENA****VIVANTO**24 x 24 x 2"  
606 x 606 x 50mm18 x 24 x 2"  
453 x 606 x 50mm12 x 24 x 2"  
301 x 606 x 50mm

Lugano





**ENDURACOLOR™***Refined surface and  
long-lasting color*

# Skyline™

---

## ADVANTAGES

*Perfect for roof decks and other  
raised floor applications.*

## PEDESTRIAN FRIENDLY

Not recommended for vehicular



**CHAMOIS**

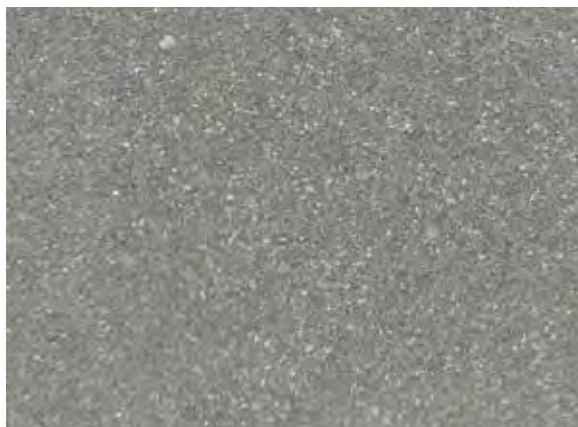

**MEDIUM GREY**



$23\frac{7}{8} \times 23\frac{7}{8} \times 2"$   
606 x 606 x 50mm



**Unilock Pedestal System**  
Contact your local Unilock  
Rep for more information.

Chamois with Medium Grey accent



**TOP**

Indian Coast with Black River banding

**BOTTOM**

Pavers Stone Cliff Grey

**Grill island and Firepit**  
Rivercrest® Wall (Buff) and  
Rivercrest Firepit (Buff)

Please contact your contractor or a local Unilock Authorized Dealer for more information and availability.

**LOOKING FOR MORE INFORMATION?**

Visit [Unilock.com](http://Unilock.com) to download a Natural Stone Brochure.



# Natural Stone

---

## ADVANTAGES

*Suitable for pool decks, wood decks, patios, entrances and concrete overlays.*

## PEDESTRIAN FRIENDLY

Not recommended for vehicular



**AUTUMN HARVEST** SANDSTONE



**INDIAN COAST** SANDSTONE



**STONE CLIFF GREY** SANDSTONE



**BLACK RIVER** LIMESTONE



12 x 24 x 7/8"  
300 x 600 x 22mm



18 x 24 x 7/8"  
450 x 600 x 22mm



24 x 24 x 7/8"  
600 x 600 x 22mm



24 x 36 x 7/8"  
600 x 900 x 22mm

*See page 138 for steps & coping.*



*From the  
rolling hills  
of Tuscany*



**BOTTOM**

Tuscan Bucine Bluestone with  
Series™ (Onyx Black) accents  
Wall: U-Cara® (Bavarian) with Series™  
(Onyx Black) accents

Please contact your contractor or a  
local Unilock Authorized Dealer for  
more information and availability.

**LOOKING FOR MORE  
INFORMATION?**

Visit [Unilock.com](http://Unilock.com) to download  
a Natural Stone Brochure.



# Natural Stone

## TUSCAN BUCINE BLUESTONE

Exclusive to **UNILOCK**

**BUCINE  
BLUESTONE®**  
from Tuscany



*Suitable for pool decks, wood decks,  
patios, entrances and concrete overlays.*

### PEDESTRIAN FRIENDLY

Not recommended for vehicular



### FLAMED SANDSTONE

**Bring a little bit of Florence and Tuscany to your project with Bucine Bluestone, exclusively from Unilock.**

The material of choice for leading artists in the history of Italian art and Renaissance, this stone has been widely used for centuries.

Our Bucine Bluestone is a sandstone, sourced directly from Italy. A classic material of beautiful, uniform grey color, it is highly durable for outdoor use, extremely versatile, easy to maintain and combines well with many other colors and materials.



12 x 24 x 1½"  
300 x 600 x 38mm



24 x 24 x 1½"  
600 x 600 x 38mm



18 x 24 x 1½"  
453 x 606 x 38mm



24 x 36 x 1½"  
600 x 900 x 38mm

*See page 138 for steps & coping.*



**LEFT**  
Travstone Beige



**RIGHT**  
Gotham Nero



**BOTTOM**  
Arbor Natural

Please contact your contractor or a local Unilock Authorized Dealer for more information and availability.

**LOOKING FOR MORE INFORMATION?**

Visit [Unilock.com](http://Unilock.com) to download a Porcelain Tile Brochure.

# Porcelain Tile



*Suitable for pool decks, wood decks, patios, entrances and concrete overlays.*

**PEDESTRIAN FRIENDLY**

Not recommended for vehicular



**GOTHAM GREY** DELCONCA USA



**EIKON GEA** CAESAR



**ARBOR BIANCO** DELCONCA USA



**GOTHAM NERO** DELCONCA USA



**EIKON TITANO** CAESAR



**ARBOR GREY** DELCONCA USA



**TRAVSTONE BEIGE** DELCONCA USA



**RIMINI** CAESAR



**ARBOR NATURAL** DELCONCA USA

Exclusive to **UNILOCK**



**UNILOCK COSMIC GREY** NEW



**UNILOCK DOVE GREY TRAVERTINE** NEW



23<sup>5</sup>/<sub>8</sub> x 23<sup>5</sup>/<sub>8</sub> x <sup>3</sup>/<sub>4</sub>"  
600 x 600 x 20mm



15<sup>3</sup>/<sub>4</sub> x 31<sup>1</sup>/<sub>2</sub> x <sup>3</sup>/<sub>4</sub>"  
400 x 800 x 20mm



15<sup>3</sup>/<sub>4</sub> x 31<sup>1</sup>/<sub>2</sub> x <sup>3</sup>/<sub>4</sub>"  
400 x 800 x 20mm







## Richcliff®

Exclusive to **UNILOCK**

Inspired by the texture of natural cut flagstone, Richcliff offers superior durability and timeless appeal ideal for driveways, patios, walkways and commercial projects. A multitude of stone textures were cast using Reala™ Technology, to ensure that finished projects will have a completely random and natural appearance. And unlike natural stone, which can crack, split and fade, Richcliff is virtually indestructible.



Dawn Mist





Deep rich colors and unique textures

# Richcliff®

Exclusive to **UNILOCK**

## ADVANTAGES

### REALA™

Cast from natural stone

### ULTIMA™

Up to 4x stronger than poured-in-place concrete

### DRIVE FRIENDLY

Random Bundle can handle vehicular loads



**DAWN MIST**



**PEBBLE TAUPE**



**PEBBLE TAUPE / DAWN MIST**  
BLENDED ON SITE

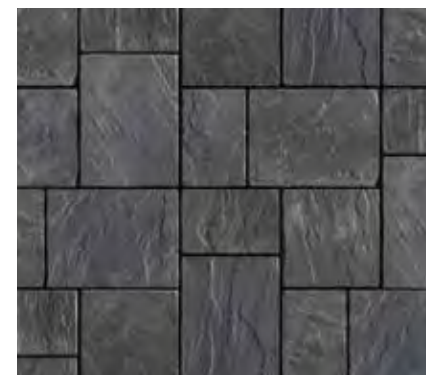

**SMOKE SHALE**



**RECTANGLE**  
12 x 9 x 2<sup>3</sup>/<sub>8</sub>"  
300 x 226 x 60mm



**SQUARE**  
9 x 9 x 2<sup>3</sup>/<sub>8</sub>"  
226 x 226 x 60mm



**SMALL RECTANGLE**  
6 x 9 x 2<sup>3</sup>/<sub>8</sub>"  
150 x 226 x 60mm



**LARGE RECTANGLE**  
21 x 12 x 2<sup>3</sup>/<sub>8</sub>"  
528 x 302 x 60mm  
NOT RECOMMENDED  
FOR DRIVEWAYS

3 UNIT RANDOM BUNDLE

Dawn Mist and Pebble Taupe with Courtstone® (Basalt) accent





## Courtstone®

Exclusive to **UNILOCK**

The polished look of Courtstone brings a luxurious, old-world elegance to driveways and walkways, with Ultima™ Concrete Technology providing up to four times the strength of conventional poured concrete. Using Realta™ Technology, the unique shapes of Courtstone were cast from real European cobblestones, but manufactured with a consistent base for efficient installation and superior interlock. It's a look that has remained popular for centuries.



Basalt with Brussels Block® (Sandstone) accent





Deep rich colors and unique textures

# Courtstone®

Exclusive to **UNILOCK**

## ADVANTAGES

### REALA™

Cast from natural stone

### ULTIMA™

Up to 4x stronger than poured-in-place concrete

### DRIVE FRIENDLY

Can handle vehicular loads

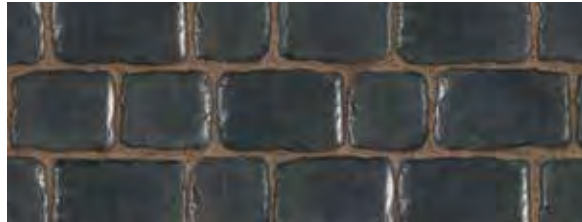

**BASALT**



**BELGIAN BLUE**



**BASALT / BELGIAN BLUE** BLENDED ON SITE



**DAWN MIST**



**PEBBLE TAUPE**



**DAWN MIST / PEBBLE TAUPE** BLENDED ON SITE



**XL RECTANGLE**  
5 1/8 x 8 3/8 x 2 3/8"  
130 x 215 x 60mm



**LARGE RECTANGLE**  
5 1/8 x 7 1/4 x 2 3/8"  
130 x 185 x 60mm



**RECTANGLE**  
5 1/8 x 6 1/2 x 2 3/8"  
130 x 165 x 60mm



**SMALL RECTANGLE**  
5 1/8 x 5 3/4 x 2 3/8"  
130 x 145 x 60mm



**SQUARE**  
5 1/8 x 5 1/8 x 2 3/8"  
130 x 130 x 60mm

5 UNIT RANDOM BUNDLE

Basalt, Belgian Blue and Dawn Mist with Copthorne® (Burgundy Red) accent







## Town Hall®

Exclusive to **UNILOCK**

The substantial proportions and unique color blending of Town Hall are modeled after historic North American clay street pavers. The timeless look makes it an excellent choice for driveways, patios, walkways and more, in either traditional or permeable applications. The rich colors and classic shape also make it popular for borders, banding and other accents. To ensure projects have a random appearance, Town Hall textures were cast from a multitude of different surfaces using Reala™ Technology. The result is vintage, streetscape charm that stands the test of time.



Heritage Red





*Deep rich colors and  
unique textures*

# Town Hall®

Exclusive to **UNILOCK**

## ADVANTAGES

### REALA™

Cast from historic brick

### ULTIMA™

Up to 4x stronger than poured-in-place concrete

### PERMEABLE

Can be installed to allow water to flow through

### DRIVE FRIENDLY

Can handle vehicular loads



**BURGUNDY RED**



**BURNT CLAY**



**OLD OAK**



**3 COLOR BLEND** BLENDED ON SITE



**HERITAGE RED**



**HERITAGE CLAY**



**HERITAGE 2 COLOR BLEND**  
BLENDED ON SITE

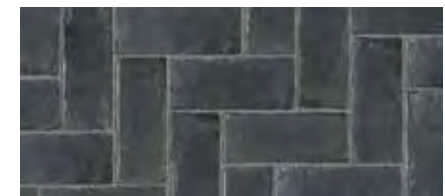

**BASALT**



**STANDARD**  
4 x 9<sup>3</sup>/<sub>4</sub> x 2<sup>3</sup>/<sub>4</sub>"  
100 x 250 x 70mm

Burgundy Red, Burnt Clay, Old Oak and Heritage Red (Blended on Site)





## Copthorne®

Exclusive to **UNILOCK**

Inspired by the rich color and timeworn beauty of European street pavers, Copthorne offers more delicate dimensions than Town Hall®. These proportions make it possible to design curved walkways and borders using Copthorne without the need for cutting. Cast using Reala™ Technology for an authentic surface appearance, and Ultima™ Concrete Technology to deliver up to four times the strength of conventional poured concrete, Copthorne offers timeless beauty.



3 Color Blend (Burgundy Red, Burnt Clay and Old Oak)





Deep rich colors and  
unique textures

# Copthorne®

Exclusive to **UNILOCK**

## ADVANTAGES

### REALA™

Cast from natural stone

### ULTIMA™

Up to 4x stronger than poured-in-place concrete

### DRIVE FRIENDLY

Can handle vehicular loads



**BURGUNDY RED**



**BURNT CLAY**



**BASALT**



**OLD OAK**



**3 COLOR BLEND**  
BLENDED ON SITE



**STEEL BLUE**



### STANDARD

2½ x 7⅞ x 2⅜"  
65 x 200 x 60mm

**Pavers:** 3 Color Blend (Burgundy Red, Burnt Clay and Old Oak) with Brussels Block® (Sandstone) accent  
**Wall:** Rivercrest® Wall (Buff) with Ledgestone™ (Buff) coping and steps





UNILOCK® COLLECTION OF

# Retaining Walls & Vertical Features

Unlimited creative possibilities exist for retaining soil or building vertical features like grill islands and firepits. Now the durability of EnduraColor™ is available, thanks to our new U-Cara® Multi-Face Wall System.

**Wall:** U-Cara® Granite Fusion Pitched with Opal Smooth accent and Universal Coping (Grey)  
**Pavers:** Beacon Hill™ Smooth (Granite Fusion) with Town Hall® (Basalt) accent



# ENDURACOLOR™

## U-Cara®

### Multi-Face Wall System

Exclusive to **UNILOCK**

This patented wall system, exclusive to Unilock, represents a revolution in wall design. With U-Cara it's now possible to design walls, pillars, planters, fire features, grill islands and more, with the refined surface and long-lasting color of exclusive Unilock EnduraColor finishes.



#### *Did You Know?*

In 2019, U-Cara received the "red dot" award for high design quality and innovation.

#### PITCHED FINISH



**BAVARIAN**



**GRANITE FUSION**

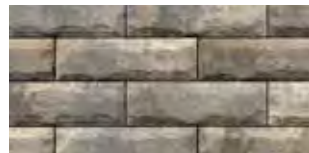

**FOSSIL NEW**

#### SMOOTH FINISH



**BAVARIAN**

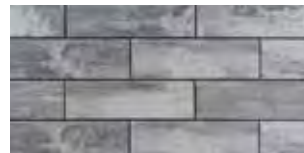

**GRANITE FUSION**

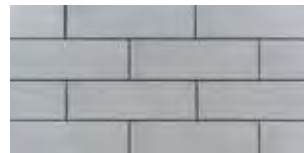

**OPAL**

#### UMBRIANO™ FINISH

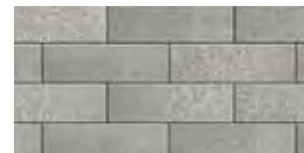

**FRENCH GREY**



**SUMMER WHEAT**

#### SERIES™ FINISH



**ONYX BLACK** 3" PANEL ONLY

Granite Fusion (Pitched) and Opal (Smooth) accent and Natural Stone step treads and coping



**LEFT**  
Granite Fusion Pitched with  
Series™ (Onyx Black) 3" panel accent

**RIGHT**  
Granite Fusion Smooth with  
Universal Coping (Grey)

**BOTTOM**  
Umbriano (Summer Wheat) with  
Natural Stone (Indian Coast) coping  
**Pavers:** Umbriano (Summer Wheat)  
with Town Hall® (3 ColorBlend)



**ENDURACOLOR™**

*Refined surface and long-lasting color*

# U-Cara®

## Multi-Face Wall System

U-Cara Fascia Panels can be placed anywhere along the patented SureTrack™ Backer Block, allowing for pattern, color and texture combinations that are impossible to achieve with other systems. The design possibilities are endless for single or double sided vertical landscape features and retaining walls.

Exclusive to **UNILOCK**

### 1 CHOOSE YOUR BASE UNIT



**UNIVERSAL BASE UNIT**  
14 x 19 x 2"  
355 x 482 x 55mm

### ADVANTAGES

**UMBRIANO™ FINISH**  
**COLORFUSION™**  
Subtly mottled color finish

**SERIES™ FINISH**  
Granite, Quartz and  
Marble surface materials

### 2 CHOOSE A BACKER SIZE



**SURETRACK STANDARD BACKER**  
6 x 8 x 6"  
150 x 200 x 150mm



**NEW SURETRACK LARGE BACKER**  
6 x 7½ x 12"  
150 x 190 x 300mm



**SURETRACK CORNER/PILLAR UNIT**  
6 x 7 x 12"  
150 x 175 x 30mm



**SURE TRACK CORNER INSERT**  
L = 2"  
50mm

### 3 CHOOSE PANEL SIZES



**6" STANDARD FASCIA PANEL**  
6 x 18½ x 2¾"  
150 x 466 x 60mm



**STANDARD FASCIA HALF PANEL**  
6 x 9¼ x 2¾"  
150 x 233 x 60mm



**CLOSED-END FASCIA PANEL**  
6 x 21 x 2¾"  
150 x 540 x 60mm



**3" FASCIA PANEL**  
3 x 9¼ x 2¾"  
75 x 233 x 60mm  
SERIES AND SMOOTH FINISH ONLY

2 UNIT CORNER BUNDLE

### 4 CHOOSE PANEL STYLES



**PITCHED**



**SMOOTH**



**UMBRIANO**



**SERIES 3" PANEL ONLY**

### 5 CHOOSE COPING



**UNIVERSAL COPING**  
14 x 19 x 2¾"  
355 x 482 x 70mm

See page 136-141 for more coping options



**LEFT**  
Rapid Pillar System (Buff) with  
Ledgestone™ (Buff) pillar caps and  
Rivercrest Wall (Buff) risers with  
Ledgestone (Buff) treads

**RIGHT**  
Coastal Slate with Natural Stone  
(Black River) coping

**BOTTOM**  
Coastal Slate with Copthorne®  
(Basalt) accent  
**Pavers:** Umbriano™ (Winter Marvel) and  
Courtstone® (Basalt) accent



# Rivercrest® Wall

Exclusive to **JUNILOCK®**

**ADVANTAGES**

**REALA™**

Cast from natural stone

**COPING OPTIONS**

We recommend using Ledgestone™ or Natural Stone.



**Did You Know?**

In 2013, Rivercrest received the "red dot" award for high design quality and innovation.



**BUFF**



**COASTAL SLATE**

**RIVERCREST FIREPIT KIT**



**RAPID PILLAR SYSTEM**



COMPLETED UNIT SHOWN  
PILLAR CAP SOLD SEPARATELY



**PILLAR UNIT**  
20 x 20 x 4½"  
500 x 500 x 114mm  
CENTER OPENING 9 x 9"



**STANDARD UNIT 1**  
8 x 9-10 x 2¼"  
200 x 230-250 x 57mm



**STANDARD UNIT 2**  
12 x 9-10 x 2¼"  
300 x 230-250 x 57mm



**STANDARD UNIT 3**  
12 x 9-10 x 2¼"  
300 x 230-250 x 57mm



**STANDARD UNIT 4**  
17 x 9-10 x 2¼"  
425 x 230-250 x 57mm

**4 UNIT RANDOM BUNDLE**



**JUMPER UNIT 1**  
8 x 9-10 x 4½"  
200 x 230-250 x 114mm



**JUMPER UNIT 2**  
12 x 9-10 x 4½"  
300 x 230-250 x 114mm



**JUMPER UNIT 3**  
12 x 9-10 x 4½"  
300 x 230-250 x 114mm



**JUMPER UNIT 4**  
17 x 9-10 x 4½"  
425 x 230-250 x 114mm



**JUMPER CORNER UNIT**  
12 x 9-10 x 4½"  
300 x 230-250 x 114mm

**4 UNIT JUMPER BUNDLE**



**LONG CORNER UNIT**  
17½ x 9-10 x 2¼"  
450 x 230-250 x 57mm



**SHORT CORNER UNIT**  
14½ x 9-10 x 2¼"  
375 x 230-250 x 57mm



**UNIVERSAL BASE UNIT**  
14 x 19 x 2"  
355 x 482 x 55mm

**2 UNIT CORNER BUNDLE**



**LEFT**  
**Grill Island:** Sierra  
**Paver:** Artline™ (Bavarian) with  
Town Hall® (Basalt) accent

**RIGHT**  
Granite Blend with Series™ (Onyx Black)  
accent and Ledgestone™ (Grey) coping  
and pillar cap

**BOTTOM**  
**Seat wall and Water Feature:**  
Granite Blend with Natural Stone  
(Stone Cliff Grey) coping  
**Paver:** Richcliff® (Dawn Mist and Pebble  
Taupe) with Courtstone® (Basalt) accent

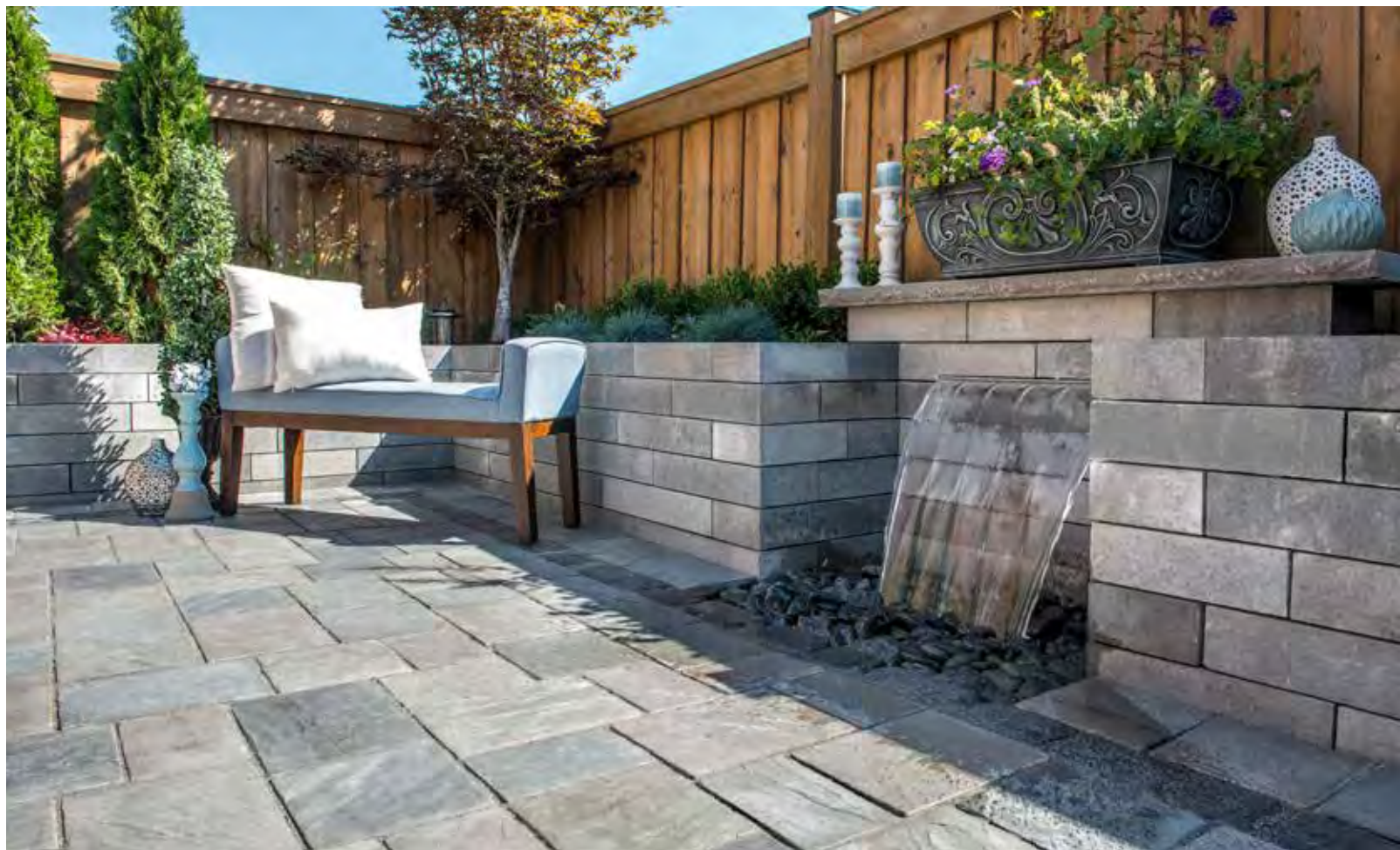



**CLASSIC**

# Lineo™ Dimensional Stone

**COPING OPTIONS**

We recommend using Ledgestone™, Natural Stone or Universal Coping.



**GRANITE BLEND**



**RIVER NEW**



**SIERRA**



8 x 24 x 4"  
200 x 600 x 100mm



8 x 20 x 4"  
200 x 500 x 100mm



8 x 16 x 4"  
200 x 400 x 100mm



8 x 12 x 4"  
200 x 300 x 100mm

4 UNIT RANDOM BUNDLE



**PILLAR UNIT / CORNER UNIT**  
8 x 12 x 4"  
200 x 300 x 100mm



**LEDGESTONE™ PILLAR CAP**  
24 x 24 x 4"  
600 x 600 x 100mm



**UNIVERSAL BASE UNIT**  
14 x 19 x 2"  
355 x 482 x 55mm



**LEFT**  
**Pizza Oven:** Sierra with Copthorne® (Basalt) accent and Brussels Fullnose™ (Sierra) details  
**Paver:** Bristol Valley® (Steel Mountain) with Copthorne (Basalt) accent

**RIGHT**  
**Firepit:** Granite with Series™ (Onyx Black) accent and LedgeStone™ (Buff) coping  
**Paver:** Bristol Valley® (Steel Mountain)

**BOTTOM**  
Sierra with Copthorne (Basalt) accent and Sandstone coping



**CLASSIC**

# Olde Quarry™

---

**COPING OPTIONS**

We recommend using Ledgestone™, Natural Stone, Universal Coping or Brussels Fullnose™.



**COFFEE CREEK**



**GRANITE**



**RIVER**



**SANDSTONE**



**SIERRA**



**15" UNIT**  
15(12) x 4 x 8"  
381 x 100 x 200mm



**12" UNIT**  
12(9) x 4 x 8"  
300 x 100 x 200mm



**9" UNIT**  
9(6) x 4 x 8"  
229 x 100 x 200mm

3 UNIT RANDOM BUNDLE



**STANDARD**  
12 x 9 x 4½"  
300 x 10 x 150mm



**COPING**  
12 x 3 x 12"  
305 x 76 x 305mm



**UNIVERSAL BASE UNIT**  
19 x 14 x 2"  
482 x 355 x 55mm



**LEFT**  
**Steps and Coping:** Sierra  
**Paver:** Copthorne® (3 Color Blend)

**RIGHT**  
River with LedgeStone  
(Buff) coping

**BOTTOM**  
River with Copthorne®  
(Basalt) accent  
**Paver:** Beacon Hill™ Flagstone  
(Alpine Grey)



## CLASSIC

# Estate Wall™

### COPING OPTIONS

We recommend using Estate Wall or Ledgestone™.



**GRANITE**



**RIVER**



**SANDSTONE**



**SIERRA**



**LARGE UNIT**  
9 x 16 x 6"  
230 x 380 x 150mm



**MEDIUM UNIT**  
9 x 12 x 6"  
230 x 320 x 150mm



**SMALL UNIT**  
8 x 9 x 6"  
200 x 230 x 150mm

3 UNIT RANDOM BUNDLE



**CORNER**  
9 x 12½ x 6"  
230 x 320 x 150mm



**COPING**  
12 x 12½ (9½) x 3"  
300 x 320 (240) x 75mm



**UNIVERSAL BASE UNIT**  
14 x 19 x 2"  
355 x 482 x 55mm



**TOP**  
River with Copthorne® (Basalt) accent  
and LedgeStone™ (Buff) coping

**BOTTOM**  
Sierra with Series (Onyx Black) accent  
and Natural Stone (Black River) pillar cap

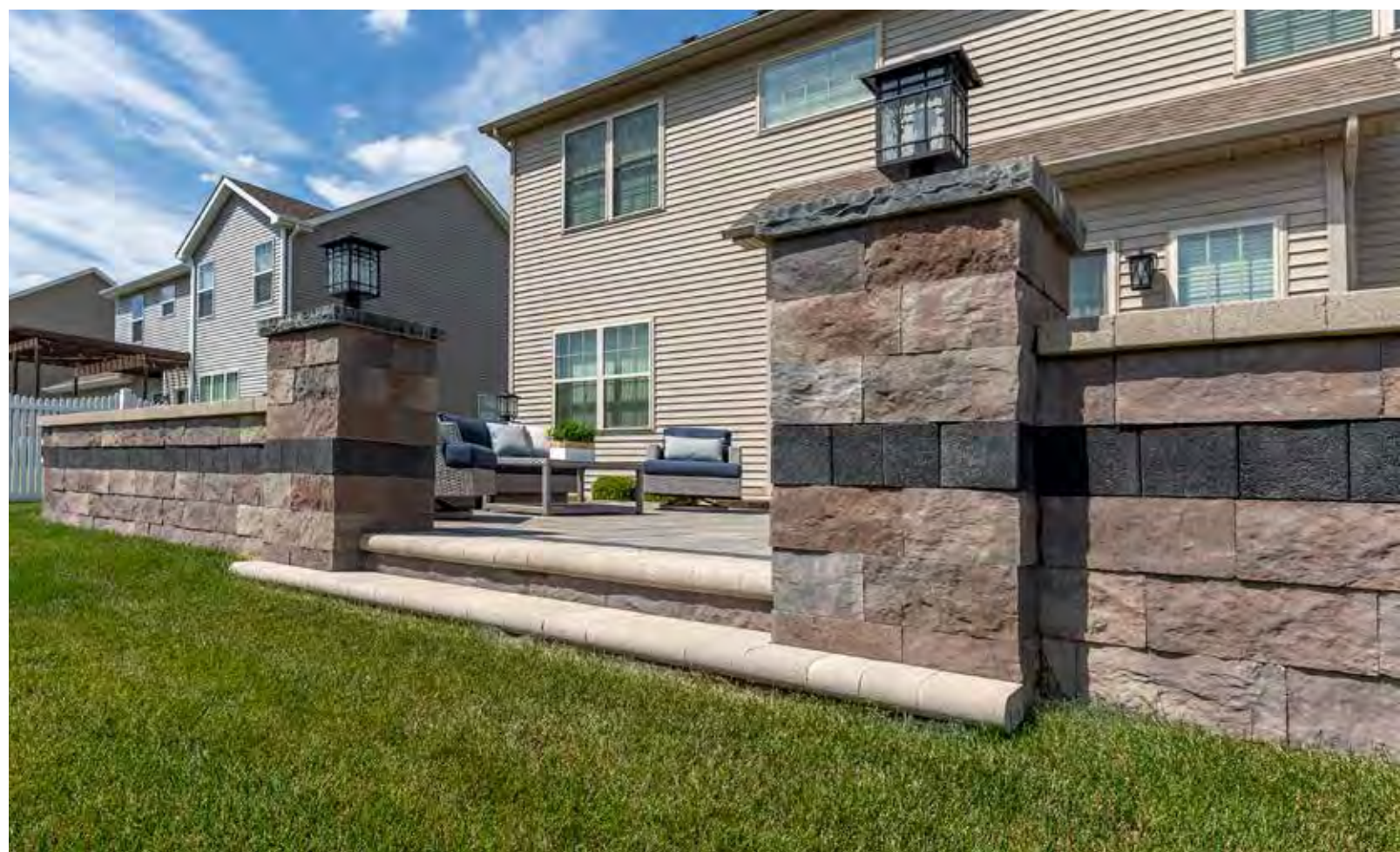

## CLASSIC

# Cumberland Wall™

### COPING OPTIONS

We recommend using Natural Stone or Ledgestone™ coping.



**RIVER**



**SIERRA**



**6" LARGE UNIT**  
15 (12½) x 6 x 9"  
380 x 150 x 230mm



**6" MEDIUM UNIT**  
12½ (10) x 6 x 9"  
320 x 150 x 230mm



**6" SMALL UNIT**  
10 (7½) x 6 x 9"  
25 (19) x 15 x 23cm



**6" CORNER / PILLAR UNIT**  
12½ x 6 x 9"  
32 x 15 x 23cm

3 UNIT RANDOM BUNDLE



**LEFT**  
Granite with Copthorne® (Basalt)  
accent and Natural Stone  
(Stone Cliff Grey) coping  
**Paver:** Copthorne® (Basalt)



**RIGHT**  
Limestone with Brussels Fullnose™  
(Limestone) coping

**BOTTOM**  
Sandstone with Series™  
(Onyx Black) accent and Brussels  
Fullnose (Sandstone) ledge  
**Paver:** Brussels Block® (Sandstone)





**CLASSIC**

# Brussels Dimensional Stone®

---

**COPING OPTIONS**

We recommend using LedgeStone™, Natural Stone or Universal Coping.

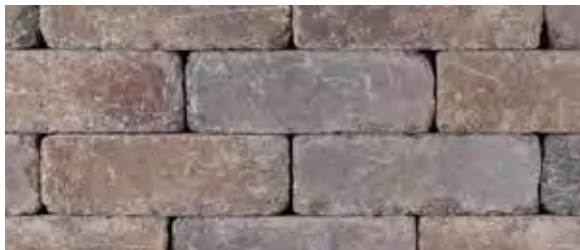

**COFFEE CREEK**



**GRANITE** SMALL TAPERED ONLY



**LIMESTONE**



**SANDSTONE**



**SIERRA**



**STANDARD**  
12 x 4 x 8"  
300 x 100 x 200mm



**SMALL TAPERED**  
9 x 3 7/8 x 7 7/8"  
229 x 100 x 200mm



**UNIVERSAL BASE UNIT**  
19 x 14 x 2"  
482 x 355 x 55mm

**SUNSET FIREPIT KITS**

**Round**



**Square**



Available Colors: Coffee Creek, Sandstone and Sierra.



**CLASSIC**

**SienaEdge™**  
**New**

**SPECIAL ORDER PRODUCT**

Minimum quantities may apply



**GRANITE**



**SIERRA**



**STANDARD / CORNER UNIT**

11½ x 39 x 7"  
290 x 1000 x 180mm



**COPING UNIT**

11½ x 39 x 7"  
290 x 1000 x 180mm

*NOTE: Coping Unit can also act as a closed end unit with the unique patented locking mechanism.*

Granite



**CLASSIC**

**SienaStone™**

---



**NATURAL**



**STANDARD 333**  
13 x 47 $\frac{1}{4}$  x 7 $\frac{1}{4}$ "  
333 x 1200 x 185mm



**COPING**  
20 x 47 $\frac{1}{4}$  x 7 $\frac{1}{4}$ "  
500 x 1200 x 185mm



**CORNER 45° (left & right)**  
20 x 43 $\frac{1}{3}$  x 7 $\frac{1}{4}$ "  
500 x 1100 x 185mm



**CORNER 90° (left & right)**  
20 x 43 $\frac{1}{3}$  x 7 $\frac{1}{4}$ "  
500 x 1100 x 185mm

See page 141 for SienaStone Smooth Step.

## CLASSIC

# PisaXL™

### COPING OPTIONS

We recommend using Pisa, Natural Stone or Universal Coping.



**SIERRA**



**NEVADA**



**GRANITE**

GRANITE ONLY IN COPING,  
CORNER & XL WALL



**CORNER**  
12 x 6 x 8"  
300 x 150 x 200mm



**COPING**  
12 x 12 x 6"  
300 x 300 x 150mm



**XL UNIT**  
12 x 16 x 6"  
300 x 400 x 150 mm



**UNIVERSAL BASE UNIT**  
14 x 19 x 2"  
355 x 482 x 55mm

Sierra XL Unit



*“Unilock walls allowed us to manage the grades on our property and create a new place for our kids to play!”*

UNILOCK® COLLECTION OF

# Steps, Treads, Coping & Caps

From classic, fullnose shapes to pitched-face edges, our steps, treads and coping offer a wide variety of choices for the finishing touch on your project.

**Wall:** U-Cara® Granite Fusion (Pitched) with Natural Stone coping and steps  
**Pavers:** Beacon Hill™ Flagstone (Granite Fusion) with Town Hall® (Basalt) accent

# Ledgestone™

## Steps, Coping & Pillar Cap



**BUFF**



**GREY**



**48" STEP**  
24 x 48 x 5<sup>7</sup>/<sub>8</sub>"  
610 x 1220 x 150mm



**COPING UNIT**  
12 x 24 x 2<sup>3</sup>/<sub>4</sub>"  
305 x 610 x 70mm



**72" STEP**  
24 x 72 x 6"  
610 x 1830 x 150mm



**CLOSED END COPING**  
12 x 24 x 2<sup>3</sup>/<sub>4</sub>"  
300 x 610 x 70mm



**24" PILLAR CAP**  
24 x 24 x 4"  
610 x 610 x 100mm



**FULLNOSE COPING**  
12 x 24 x 2<sup>3</sup>/<sub>8</sub>"  
300 x 610 x 60mm



**28" PILLAR CAP**  
28<sup>1</sup>/<sub>2</sub> x 28<sup>1</sup>/<sub>2</sub> x 4"  
740 x 740 x 100mm



**LARGE COPING UNIT**  
13<sup>1</sup>/<sub>2</sub> x 30 x 2<sup>3</sup>/<sub>4</sub>"  
343 x 762 x 70mm



**LARGE CLOSED END COPING**  
13<sup>1</sup>/<sub>2</sub> x 30 x 2<sup>3</sup>/<sub>4</sub>"  
343 x 762 x 70mm



**TOP** Fullnose Buff

**BOTTOM** 48" Steps Buff

### ADVANTAGES

**REALA™**  
Cast from natural stone

**STONEMARK™**



# Fullnose Coping

## 6 x 12" Fullnose



**COFFEE CREEK**



**CHARCOAL** NEW



**SANDSTONE**



**SIERRA**



**STANDARD**  
6 x 12 x 2<sup>3</sup>/<sub>4</sub>"  
150 x 300 x 70mm

## Brussels Fullnose™



**COFFEE CREEK**



**CHARCOAL** NEW



**SANDSTONE**



**SIERRA**



**STANDARD**  
6 x 12 x 2<sup>3</sup>/<sub>4</sub>"  
150 x 300 x 70mm

### ADVANTAGES

#### ANTIQUED FINISH

Distressed, timeworn finish



**TOP** Antiqued Sandstone

**BOTTOM** 6x12 Fullnose Sierra

# NaturalStone Steps, Coping & Pillar Cap

## SANDSTONE



## INDIAN COAST



## STONE CLIFF GREY

## LIMESTONE



## BLACK RIVER



### 4' ROCKFACE COPING

48 x 12 x 2"  
1200 x 300 x 50mm

### 6' ROCKFACE COPING

72 x 12 x 2"  
1830 x 300 x 50mm



### 4' FULLNOSE

48 x 12 x 2"  
1200 x 300 x 50mm

### 6' FULLNOSE

72 x 12 x 2"  
1830 x 300 x 50mm  
INDIAN COAST ONLY



### 4' ROCK FACE STEP

48 x 16 x 6"  
1200 x 410 x 150mm

INDIAN COAST AND  
BLACK RIVER ONLY



### 24" PILLAR CAP

24 x 24 x 4"  
600 x 600 x 100mm

### 28" PILLAR CAP

28 x 28 x 4"  
710 x 710 x 100mm

Exclusive to **JNILOCK**

## TUSCAN BUCINE BLUETONE



## FLAMED SANDSTONE



### STEP NEW

24 x 48 x 6"  
600 x 1200 x 150mm



### COPING NEW

14 x 48 x 2"  
356 x 1200 x 50mm



### PILLAR CAP NEW

24 x 24 x 2"  
600 x 600 x 50mm

BUCINE  
BLUESTONE®  
from Tuscany

# Architectural Coping & Pillar Cap **New**



**BUFF**



**CHARCOAL**



**COPING**

24 x 14 x 2<sup>3</sup>/<sub>8</sub>"  
609 x 355 x 60mm



**PILLAR CAP**

28 x 28 x 3"  
711 x 711 x 76mm

## ADVANTAGES

Enhanced surface appearance

**ENDURACOLOR™**



**TOP** Buff Pillar Cap

**BOTTOM** Charcoal Coping

# Universal Coping



TAN



GREY



**COPING/STEP UNIT**  
14 x 19 x 2¾"  
360 x 480 x 70mm



**TOP** Grey Coping  
**BOTTOM** Tan Step Treads

# Pisa2™



GRANITE



NEVADA



SIERRA



12 x 12 x 3  
300 x 300 x 75mm

## ADVANTAGES

**ENDURACOLOR™**

# Estate Wall™

---



**GRANITE**



**RIVER**



**SANDSTONE**



**SIERRA**



12½ (9½) x 3 x 12"  
320 (240) x 75 x 300mm

# SienaStone™

---



**NATURAL**



**NEVADA**



**SIERRA**



**COPING/STEP UNIT**  
20 x 39 x 7¼"  
500 x 1000 x 185mm

# SienaStone™ Smooth

---



**BUFF**



**GREY**



**48" STEP**  
47¼ x 7 x 20"  
1200 x 180 x 500mm

Note: 2 Edge details available on the same unit (Chamfer and Rounded) Contact a Unilock representative for more information.



A photograph of a stone wall and pergola structure. The wall is made of stacked stone blocks. Above the wall is a pergola with a wooden top and decorative brackets. In the foreground, there is a planter box with pink and purple flowers and green foliage. The image is partially obscured by white geometric shapes.

# Making Your Project Unique

Using Unilock finishing touches can make all the difference in the world to your finished product. With special attention to the details, your landscape dreams can soar above your expectations!

**Wall:** U-Cara® Bavarian (Pitched)  
**Pavers:** Beacon Hill™ Smooth (Bavarian)

# Borders & Banding

---

The creative use of Unilock borders and banding adds a touch of elegance to your driveway, walkway, patio or vertical features. Use them to enhance your design selections and create distinctive designs.



PAVER Richcliff® (Smoke Shale)  
ACCENT Courtstone® (Basalt)



PAVER Mattoni™ (Sable Blend)  
ACCENT Mattoni (Dark Charcoal)

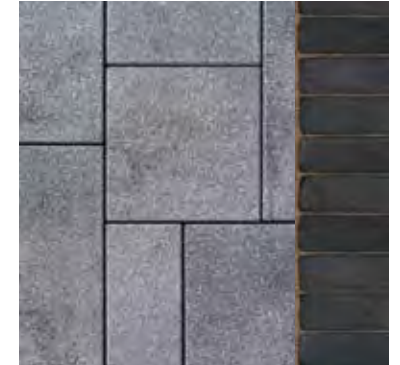

PAVER Series™ (Cobalt Grey)  
ACCENT Courtstone (Basalt)



PAVER Courtstone (Basalt)  
ACCENT Copthorne® (Steel Blue)



PAVER Bristol Valley® (Steel Mountain)  
ACCENT Copthorne (Basalt)



PAVER Beacon Hill™ Flagstone (Granite Fusion)  
ACCENT Town Hall® (Basalt)

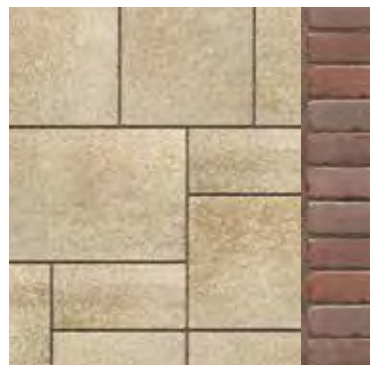

PAVER Umbriano (Summer Wheat)  
ACCENT Copthorne (3 Color Blend)

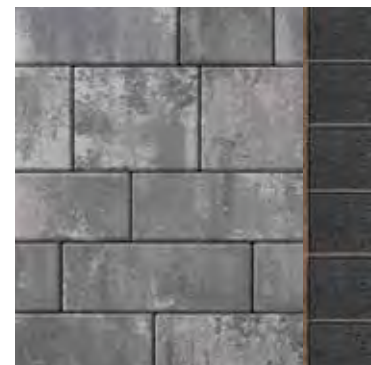

PAVER Artline™ (Steel Mountain)  
ACCENT Series (Onyx Black)



PAVER Thornbury™ (Bavarain)  
ACCENT Town Hall (Old Oak)





WALL Rivercrest® Wall (Coastal Slate)  
ACCENT Cophthorne® (Basalt)



WALL U-Cara® (Bavarian) Smooth Face  
ACCENT U-Cara (Bavarian) Pitched Face

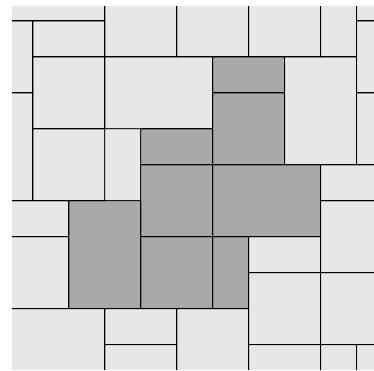

### LAYING PATTERNS

One of the factors that makes your landscape project unique, is the laying pattern you choose. Your contractor can recommend choices that will utilize the best laying pattern for the product you've selected.

*Visit [Unilock.com](http://Unilock.com) for laying patterns.*



WALL U-Cara (Opal Blend Smooth)  
ACCENT U-Cara (Series Onyx Black)



WALL Lineo™ Dimensional Stone (Granite)  
ACCENT Series (Onyx Black)

### JOINTING SAND COLOR CHOICE

Jointing sand color is another way to enhance your landscape dreams, offering a remarkable visual effect by creating stunning contrasts that can visually tie a hardscape together.

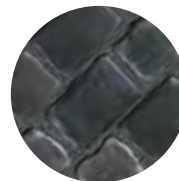

**BLACK SAND**

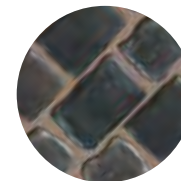

**TAN SAND**

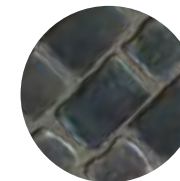

**GREY SAND**

# Firepits & Fire Features

---

Imagine the pure joy of sitting around an outdoor firepit with your friends and family! Envision getting cozy on a cool night and enjoying the mesmerizing flames from your backyard Unilock firepit or fireplace. It's a dreamer's dream come true!

## *Did You Know?*

Unilock products can be used to build a custom fire feature that's perfect for your project.



**Top:** Rivercrest® (Bella) Fireplace with Series and Universal Coping  
**Bottom:** Lineo™ Dimensional Stone with Ledgestone™ coping  
**Left:** U-Cara® (Pitched) with Universal Coping

**Rivercrest Firepit Kit** See page 119 for color options.



**REMEMBER** To ensure a long lasting fire feature, direct exposure to extreme heat from an open flame should be avoided. Always construct fire features with a protective heat barrier such as a metal insert, refractory blocks or approved firebrick to prevent potential heat damage.



**FIREPIT GRILL**

Rivercrest firepit kits comes with a firepit grill that fits securely into the firepit.

**Sunset Firepit Kit** Firepit Grill accessory is optional. See page 129 for color options.



**Pre-built Elements**

SPECIAL ORDER

**BELLA FIREPLACE**

Rivercrest® Wall and Series accents.



**TUSCANY FIREPLACE**

Brussels Dimensional Stone® and Copthorne® accents.



**BARCELONA FIREPLACE**

Brussels Dimensional Stone® and Umbriano® accents.

# Outdoor Kitchens

---

The evolution of the backyard BBQ is a Unilock specialty. We have a fabulous selection of products to help build custom grill islands and outdoor kitchens that fit your space perfectly and will make you the culinary star of the neighborhood!



# U-Cara® Modular System

The U-Cara® Modular System offers a variety of aluminum frames that can be mixed and matched to construct vertical features like grill islands. Speak to your contractor to select a design and a U-Cara fascia panel finish to suit your project.

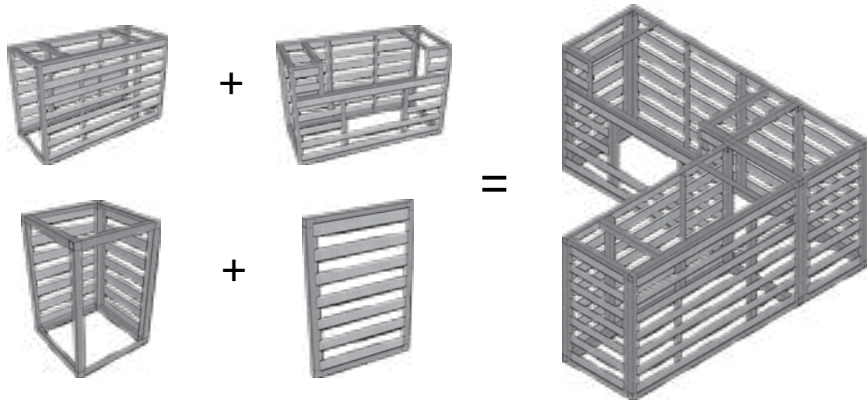

**With the U-Cara Modular System you can build Grill Islands, Bars, Back splashes, Fire Tables and Pillars.**

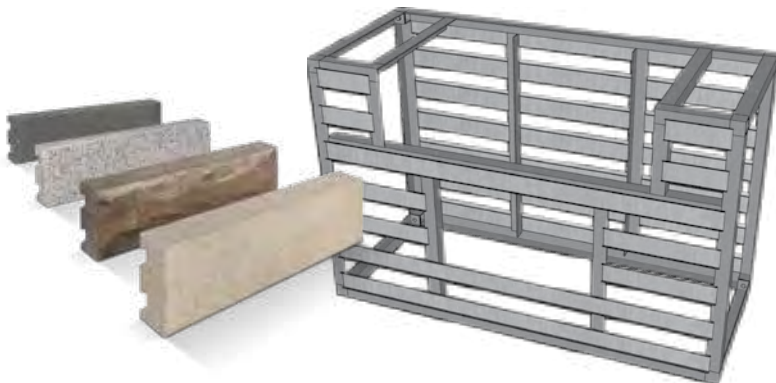

**LOOKING FOR MORE INFORMATION?**  
Visit [Unilock.com](http://Unilock.com) to download the U-Cara Modular System Brochure.



# Pillars & Water Features

---

## Pillars

Pillars add a sense of permanence and strength to your landscape dreams, creating visual interest with height variation and functionality. Pillars are great for creating a visual anchor to walls and a place for extra lighting. By adding pillars, you can let your imagination run wild!

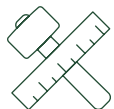
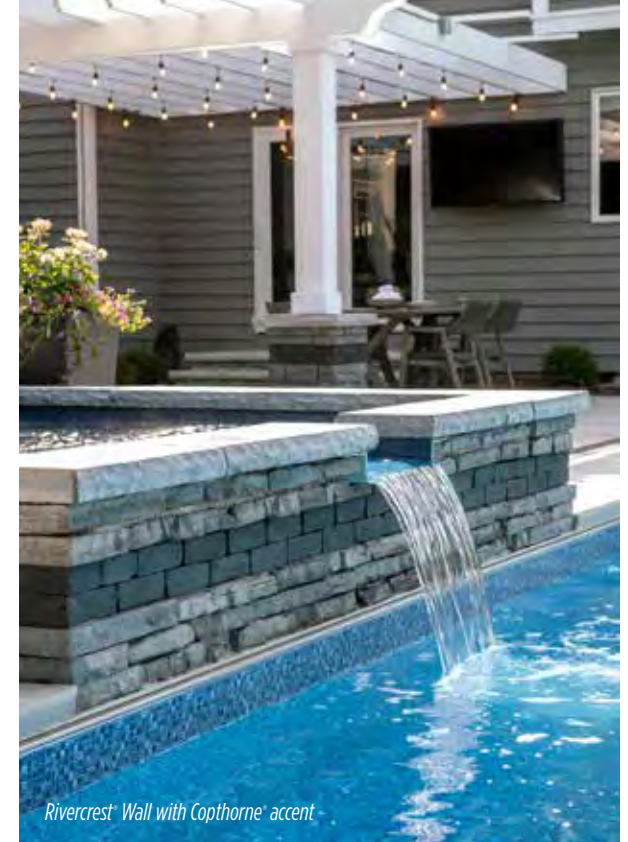

**Looking for Something Different?**  
Speak to your contractor about using Unilock products to build a custom feature that's just right for your project.



## Water Features

From fountains and ponds to waterfalls and custom water features, these soothing additions are a popular way to enhance your landscape. Unilock products can be used to build an endless variety of water features, perfect for your landscape dream.



*U-Cara (Smooth) with U-Cara (Pitched) accent*



*Brussels Dimensional Stone  
with Town Hall' accent*

## U-Cara Wall Mount System

The U-Cara Wall Mount System allows you to put the finishing touches on your project by cladding existing structures like unsightly exposed foundation areas or concrete steps with U-Cara fascia panels.



**LOOKING FOR MORE INFORMATION?**  
Visit [Unilock.com](http://Unilock.com) to download the U-Cara Wall Mount System Brochure.

# Where Do I Begin?

*Sometimes it can seem like a daunting task to turn your landscape dreams into reality. We understand and we're here to help you every step of the way. Whether you are looking to create a simple front entry or a complete outdoor living installation, no project is too big or too small for Unilock! We've heard the question asked many times, "Where Do I Begin?" The short answer? You begin with Unilock!*





STEP

1

# Learn About Unilock Superior Products

Discover revolutionary Unilock technologies that have led to the creation of the world's finest concrete products.



The more you know, the more you'll understand why Unilock is the best choice of all.



# Exclusive Unilock Technologies

All products are not created equal. Many products look great when they're first installed, but after time the difference shows. For over 48 years, the very best designers and contractors have relied on Unilock to supply cutting edge paver and wall products that enable them to build extraordinary projects that stand the test of time.



Courtstone



Town Hall



Rivercrest



**Without Ultima**  
*Deteriorating brick pavers exposed to deicing salts*

**With Ultima**  
*Unilock Town Hall pavers are built to last*

## Reala™

Utilizing REALA technology, a multitude of natural stone surfaces, brick and historic cobblestones are cast to create a wide variety of authentic textures with consistent dimensions that are more cost efficient to install.

**PRODUCTS WITH REALA:**  
COPTHORNE®, COURTSTONE®, RICHCLIFF®, TOWN HALL®, RIVERCREST® WALL, AND LEDGESTONE™



## Ultima™

Only Unilock has the technology in North America to manufacture Ultima Concrete resulting in pavers up to four times the stronger than poured concrete. With Ultima, the look you purchase is the look that will last.

**PRODUCTS WITH ULTIMA:**  
COPTHORNE®, COURTSTONE®, RICHCLIFF® AND TOWN HALL®

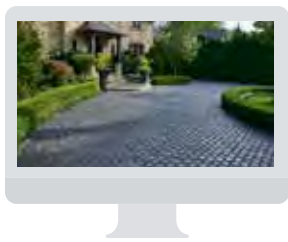

*Learn more about Unilock Technologies at [Unilock.com](http://Unilock.com).*

# Exclusive Unilock Technologies

---

Unilock is the only company in North America with memberships in Eurobeton and Stein + Design, two prestigious European concrete product innovation groups, which give us exclusive access to leading edge product designs and manufacturing processes.

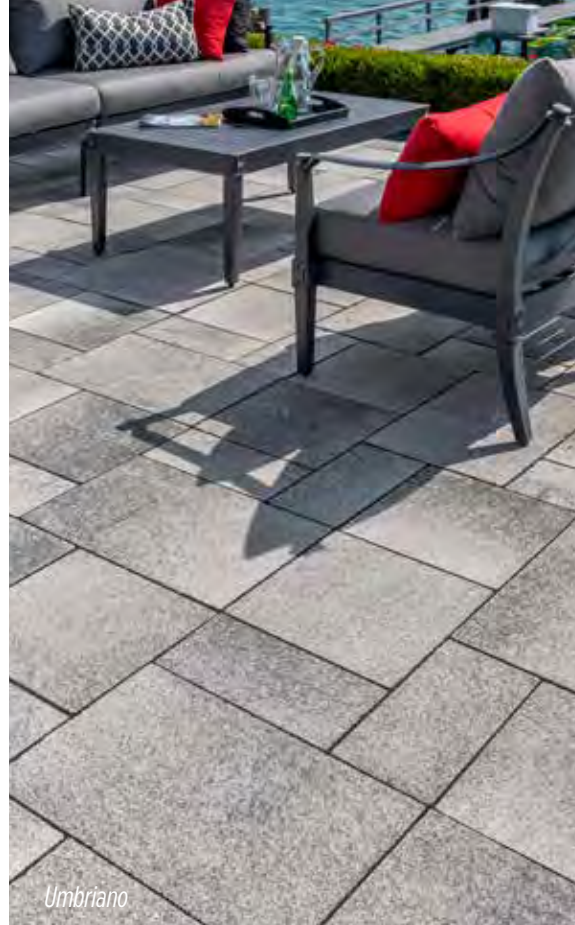

## ColorFusion™

The look of natural granite is achieved when color and granite particles are randomly dispersed using proprietary ColorFusion technology to achieve a unique mottled surface.

**PRODUCTS WITH COLORFUSION:**  
UMBRIANO™ AND U-CARA®



With EasyClean, the occasional spill doesn't have to leave a lasting mark on your new pavement. Unlike costly after-market sealers which merely coat the top, EasyClean goes beyond the surface and becomes integral to the product during manufacturing, making spills and other debris easier to clean before a stain can develop.

**PRODUCTS WITH EASYCLEAN:**  
ARTLINE™, ARCANA™, BRISTOL VALLEY®, GRANITO™ AND UMBRIANO™

Nothing protects pavers from stains like EasyClean.

- ✓ Pavers are pre-sealed at the factory
- ✓ Enhanced resistance to weathering
- ✓ Reduced dirt absorption
- ✓ Stains from leaves, coffee, ketchup, mustard, wine and BBQ oils are easier to remove

# Unilock Paver Reference Guide

UNILOCK PAVERS	Classic	EnduraColor	Elegance	Classic Coat	EasyClean	Reala	Ultima	ColorFusion	Permeable	Vehicular
Arcana™		•			•					
Artline™		•			•					•
Beacon Hill™ Flagstone 60mm		•								
Beacon Hill Flagstone 80mm		•								•
Beacon Hill Flagstone XL		•								
Beacon Hill Smooth		•								
Beacon Hill Smooth XL		•								
Bristol Valley®		•			•					
Brussels Block®	•									•
Brussels Premier™		•								•
Copthorne®		•	•			•	•			•
Courtstone®		•	•			•	•			•
Eco-Priora™	•	•							•	•
Granito™		•			•					•
Hollandstone™	•									•
Holland Premier™		•								•
Mattoni™		•								•
Richcliff®		•	•			•	•			•
Series 60mm		•								
Series 70mm		•								•
Series 80mm		•								•
Skyline™		•								
Thornbury™		•							•	•
Town Hall®		•	•			•	•		•	•
Treo™ Smooth		•							•	•
Tribeca Cobble™		•							•	•
Umbriano™		•			•			•		
Westport™	•			•						•

# Unilock Wall Reference Guide

UNILOCK WALLS	Classic	EnduraColor	StoneMark	Reala	ColorFusion	Two-Sided	Garden	Engineered
Brussels Dimensional Stone®	•					•	•	
Cumberland Wall™	•					•	•	•
Estate Wall™	•					•	•	•
Lineo™ Dimensional Stone	•					•	•	
PisaXL®	•						•	•
Rivercrest® Wall			•	•		•	•	•
SienaEdge™	•					•		•
SienaStone™	•							•
Olde Quarry™	•					•	•	•
U-Cara®		•			•	•	•	•

STEPS	Classic	StoneMark	Reala	Natural
Ledgestone™		•	•	
SienaStone	•			
Natural Stone Sandstone				•
Natural Stone Limestone				•

## COPING PAIRING OPTIONS

UNILOCK COPINGS	Architectural Coping	Ledgestone	Natural Stone	Brussels Fullnose	Estate Wall	Pisa
Brussels Dimensional Stone		•	•	•		
Cumberland Wall		•	•			
Estate Wall		•	•		•	
Lineo Dimensional Stone		•	•			
Pisa2			•			•
Olde Quarry		•	•	•		
Rivercrest Wall		•	•			
U-Cara	•	•	•			

STEP

2

## Learn About The Process

Now that you've been inspired by our many different products and ideas, it's time to get down to the nitty gritty. We want you to have all of the information you need to make your project a huge success.



**3D Rendering** Created with Uvision® 3D Design Software

The construction process on the following pages will guide you through the various steps of a landscape project. As always - the helpful people at Unilock are always here to answer your questions and provide solutions.

# Construction Process

## STEP 1 | EXCAVATION

The first step in any project is excavation of grass and topsoil. The depth will depend on two factors:

1. Soil Type - Clay soil requires deeper excavation; sandy soil requires less.
2. Use - Heavy loads like driveways and retaining walls require deeper excavation; lighter loads like patios and walkways require less.

Depth of excavation can be reduced by adding DriveGrid™ once the soil has been removed.

## STEP 2 | GRAVEL BASE

The excavated area will be filled with a gravel base. This gravel base needs to be:

- > **Strong enough** to handle the load of whatever is placed on the surface.
- > **Free draining** so that water drains out of the base into the subsoil. Retaining walls may require a perforated drain pipe in the gravel base to direct water away from the base of the wall.
- > **Extended** at least six inches beyond the edges of the finished paver surface.
- > **Compacted** in several layers, using the proper equipment.



## STEP 3 | BEDDING LAYER

A 1" (25mm) layer of sand or tiny stone chips is spread out and smoothed on top of the solid gravel base.

This layer allows paver or wall units to be leveled or sloped for smoothness and drainage.

Some contractors may recommend a poured concrete surface instead of a typical bedding layer, which is fine as long as the concrete is accurately poured and sits on a stable and well-drained base. *Note: Once concrete is poured, the height of paver or wall units can no longer be adjusted.*

## PAVER CONSTRUCTION

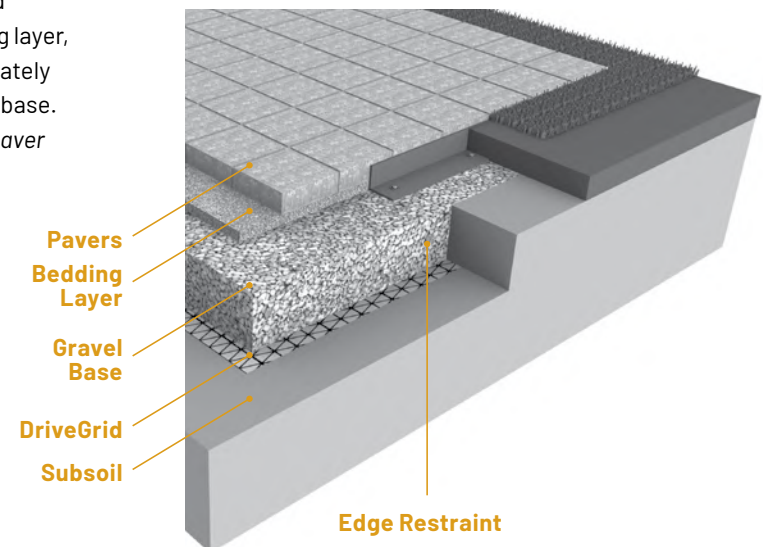

**Need help finding a qualified contractor?**

Call us at 1-800-UNILOCK or register online at [Unilock.com](https://www.unilock.com) and we'll match you with a Unilock Authorized Contractor in your area.



## WALL CONSTRUCTION

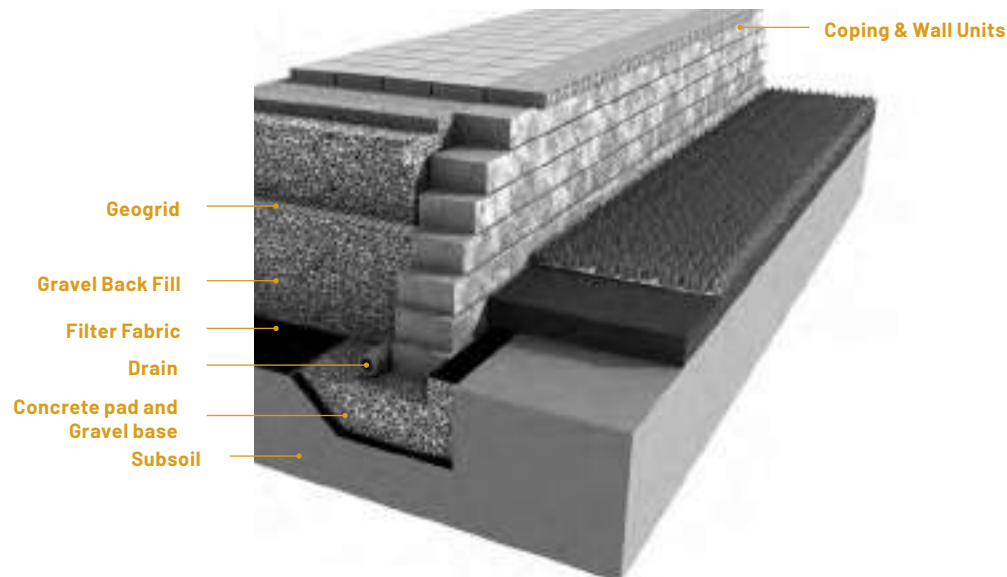

### STEP 4 | RESTRAINT SYSTEM

For pavers, an edge restraint will be secured with long metal spikes or a concrete edge will be installed to prevent perimeter pavers from drifting out. For walls, glue may be used to secure rows of blocks. Larger retaining walls may require geogrid every few layers to secure the wall into the soil that is being retained.

### STEP 5 | JOINT MATERIAL

The color you choose for joint material impacts the overall aesthetic. It also plays an important role between pavers by keeping out weeds and other debris. Your contractor can help you decide which joint material is right for your project.

*There are two types of joint material to choose from:*

**Basic Jointing Sand** – Years ago, this was the only joint material available. As it wears away, issues with weeds could arise. If you choose a basic sand, we recommend that you use a joint stabilizing sealer and be prepared to replenish the sand when needed.

**Polymeric Sand** – This special sand stays in place longer because it is combined with a binding agent. However, it's not right for every project and needs to be installed with care to prevent hazing.

### STEP 6 | SEALING

Unilock pavers will be durable with, or without, a sealer. Some homeowners choose to apply a sealer to enhance the color of the pavers, while others choose to appreciate the color of the pavers as they are. Some Unilock pavers are sold factory sealed. If you choose to seal, you should plan to re-seal every 3-5 years.

#### Factory Sealed Products

Elegance® Pavers and Unilock pavers manufactured with EasyClean™, have been pre-sealed in the factory and do not require sealing after installation. To clean and brighten the surface at any time, a gentle power washing of the surface is recommended. If you still wish to re-seal the surface, you must wait a minimum of 3 years before applying sealer. Only use solvent based sealers.

*REMEMBER: A quality project relies on a quality foundation. We recommend hiring a professional contractor.*

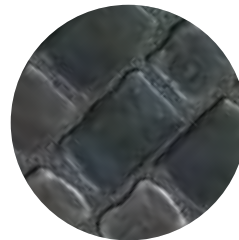
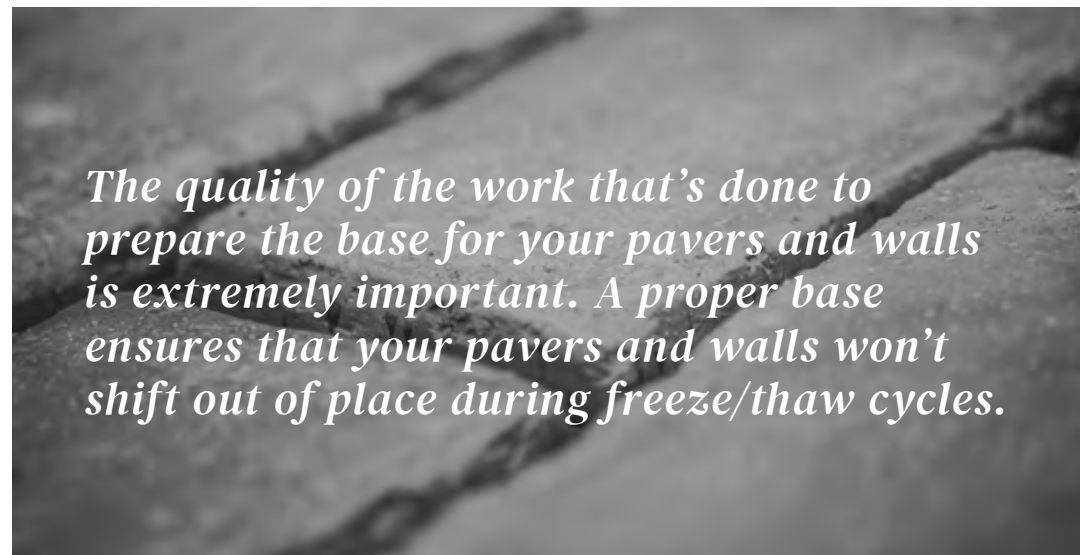

**BLACK SAND**

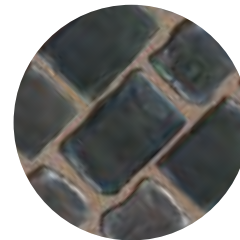

**TAN SAND**

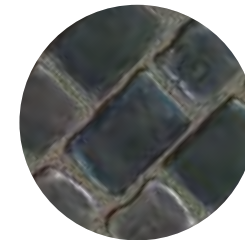

**GREY SAND**

STEP

3

## Find a Contractor

*Contact us at 1-800-UNILOCK or register online at [Unilock.com](http://Unilock.com) and we'll match you with a Unilock Authorized Contractor in your area.*

Choosing the right contractor for your project is the most important decision of all because even the best materials can be spoiled by poor installation and workmanship. Be sure to ask the right questions and keep in mind that the cheapest quote is rarely the best option.

Our Referral Program will match you with a highly competent contractor who meets the rigid standards we impose to ensure the best quality work and results. Simply contact us online, by phone or at one of our locations and we'll help you find a contractor guaranteed to do the job right.

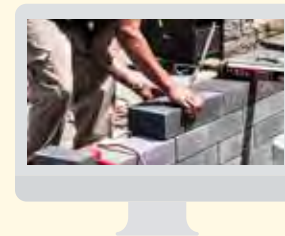

*Learn more about  
Authorized Contractors  
at [Unilock.com](http://Unilock.com)*

# 8 Tips for Choosing A Contractor



## 1 WORKMANSHIP

- > Ask to see projects the contractor completed more than two years ago so you can see how their work holds up over time.
- > Are the pavers laid in a way that minimizes awkward cuts?
- > Are the curves of the project cut in a way that minimizes large gaps?
- > Have edge restraints been used and still in place?
- > How long does the contractor guarantee the work? How many warranty claims has the company had in the past two years?

## 2 SUB-CONTRACTING

- > Some contractors will hire other companies to perform parts of the work, like lighting and irrigation. Be sure to ask the contractor about these sub-contractors and how they will be managed.

## 3 RELEVANT EXPERIENCE

- > How long has the contractor been installing pavers and walls?
- > Has the contractor installed projects in the past with the features you're considering (eg. a raised patio, retaining wall or water feature)?

## 4 BASE PREPARATION

- > What are the contractor's base preparation methods?
- > What materials are used and why?
- > Is there a standard procedure for base preparation or will the contractor assess your site's unique needs?

## 5 TIMING

- > Ask the contractor how far in advance they are booking projects and how long your project might take.
- > What are the contractor's payment terms?
- > Is an upfront deposit required to secure the timing of the project?

## 6 DOCUMENTATION

- > Does the contractor have the proper licensing for their work?
- > Does the contractor have liability insurance and are employees covered by Workers Compensation?
- > Will there be permits required for the job and if so, who is responsible to secure them?

## 7 COMPATIBILITY

- > Do you like this contractor? Can you easily communicate and understand each other? Is this someone you can trust?
- > Ask if the person you're meeting will be on site throughout the project or if someone else in the company will be your day-to-day contact person.
- > Contacting references can help you understand how the contractor operates throughout a project.

## 8 DESIGN

- > Does the contractor offer a design service? Is there a cost for this?
- > Is the design hand drawn or rendered in 3D?
- > Are the contractor's designs something you would like for your project?

STEP

4

## Protect Your Investment

Learn how to take care of your Unilock products to ensure that they stay beautiful and functional for years to come.

### Weeds Can Be Prevented

When a proper base is installed, there is no soil directly beneath your pavers for weeds to grow. However, if the joints are not kept full with jointing material, it is possible for dirt and weed seeds to blow in from the surrounding area and germinate in the joints.

**In the past** - a basic sand was the only jointing material available. Unless it was replenished regularly, rain would erode the sand, leaving joints vulnerable to weeds.

**Today** - new varieties of sand stabilizing compounds and polymeric jointing material are available which relieves homeowners from this maintenance burden. See page 161 for more information on jointing material choices.



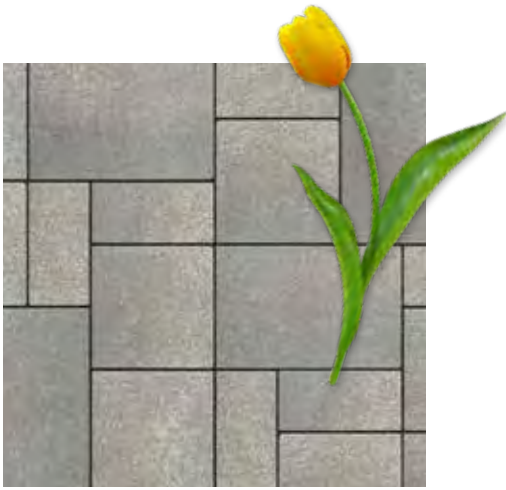

## Spring Maintenance

Although most Unilock® products are designed to be low maintenance, there are a number of preventative maintenance steps that can be performed each spring to ensure that your project keeps its pristine appearance throughout patio season.

Check for “creep” – this is where the stones push out (due to winter stress, traffic or failure of the edge restraint), dips, deformations or stains. Should you discover any of these problems, they are all fixable.

Visit [Unilock.com](http://Unilock.com) or speak to our friendly Unilock staff to find solutions.



## Fall Maintenance

The most important thing to do in the fall is to keep leaves and other debris off your stones. Remove any plant pots, furniture, urns and BBQs that can leach rust onto your surfaces.



## Winter Maintenance

While Unilock products are de-icing salt resistant, using calcium-based products or rock salt (sodium chloride) to melt ice is highly recommended. Use a plastic shovel and plastic blade protectors on snow plows or blowers to protect the surface.

**NOTE: Avoid magnesium-based de-icing products as they are very aggressive and may cause damage to the concrete surface.**



Search more FAQ's  
at [Unilock.com](http://Unilock.com).

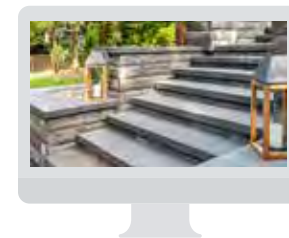

# Prestigious Public Spaces

PROS WHO KNOW, CHOOSE UNILOCK

Many of the same Unilock products available to homeowners in this catalog have been trusted by professionals to perform in large scale commercial projects.

For years, Architects, Engineers, Installation Contractors and Designers across North America have turned to Unilock for leading edge designs and products that are proven to withstand the demands of heavy use.

## *Did You Know?*

Unilock leads the industry with proprietary technologies?

Navy Pier, Chicago, IL.  
Designer: James Corner Field Operations





**Buckingham Fountain, Chicago Illinois.**  
Designer: Thompson Dyke & Associates

Choose the brand  
the pros choose.  
There's nothing  
better than Unilock  
when it comes to  
withstanding the  
test of time.



**Little Caesars Arena, Detroit, MI.**  
Designer: SmithGroup.



**Indianapolis Motor Speedway, Indianapolis, IN.**  
Designer: Browning Day Mullins Dierdorf.

# Our Quality Commitment

---

Unilock was the first concrete paver manufacturer in North America to offer a Lifetime Guarantee, and since then we have continued to stand behind it to ensure customers are completely satisfied with our products. With almost 2 billion stones in the ground, that's quite the commitment!

Our products are better and stronger than other brands. In fact, our internal standards of manufacturing in the USA and Canada far exceed industry standards set by ASTM (American Society for Testing and Materials) and CSA (Canadian Standards Association) and other European organizations.



## LIFETIME GUARANTEE - RESIDENTIAL

Our Transferable Lifetime Guarantee warranties the structural integrity of Unilock concrete paving stones and retaining wall units when used in residential applications. It covers any structural failure or deterioration of the concrete unit resulting from normal use or from the reasonable application of sodium chloride (common rock salt used for deicing). StoneMark™ products have the same warranties as Unilock paving stones and retaining walls, but cannot be warrantied against damage resulting from de-icing products.

Any materials installed and maintained to our guidelines, and subject to normal wear, that prove defective, will be replaced without cost. Proof of purchase is required. Customers are encouraged to submit receipts to us as soon as their project is complete, using the Unilock Warranty Registration Form on our website (Unilock.com).

Purchasers need to ensure that the product they purchase is appropriate for their intended application; for example, only certain thicknesses of products are appropriate for driveways. Color matching of the replacement product and/or lost time cannot be guaranteed and labor costs related to installing replacement product is not included. Unilock reserves the right to seek a professional diagnosis and opinion to determine the exact cause of the product failure. If the failure falls within our warranty parameters, Unilock will replace the defective product.

**EXCLUSIONS** – Unfortunately, some things are beyond the control of Unilock, and are therefore not covered by this warranty. These include: naturally occurring efflorescence, hazing from polymeric jointing sand, scratching and chipping resulting from snow removal or construction equipment,

damage caused by natural or un-natural disasters, or negligence by anyone other than Unilock. The Unilock warranty also does not cover deterioration or damage as a result of poor design or poor installation practices that are contrary to specifications as laid out by ICPI (Interlocking Concrete Pavement Institute) and the NCMA (National Concrete Masonry Association). For more information please visit [www.icpi.org](http://www.icpi.org) and [www.ncma.org](http://www.ncma.org). Additionally, please refer to the Maintenance, Color and Installation Advisories.

## MAINTENANCE ADVISORY

### 1. Cleaning and Sealing

As with anything that is outdoors, Unilock products are subject to harsh weather, dust, acid rain, leaf stains, water stains and general wear from foot or vehicular traffic. Therefore, periodic cleaning using environmentally safe detergents designed for cleaning concrete is recommended to maintain a bright, fresh appearance.

To make subsequent cleaning easier and more effective, a concrete sealer can be applied to new or cleaned products to help prevent the penetration of substances that can cause stains.

There are many types of concrete cleaners and sealers on the market. Always read the instructions carefully before using the product to make sure that it will function as expected. Testing first, in a small unobtrusive area, is always a good idea to ensure the results are acceptable. Consult your local hardscape dealer to find the products best suited for your paver or wall installation.

***Visit [Unilock.com](http://Unilock.com) to register for your Transferable Lifetime Guarantee.***



## 2. Winter Maintenance

Snow removal by way of metal blades on plows or shovels will scratch and chip the surface of pavers, causing permanent damage. To mitigate this risk, metal snow clearing blades must always have a polyurethane or rubber cutting edge attached when plowing pavers.

De-icing Salts - The use of de-icing products on paver surfaces is important for safety and to help mitigate snow accumulation. Most de-icing products will have some effect on concrete, even if the product label indicates that it is safe on concrete. If you must use a de-icing product, we recommend that you use Sodium Chloride (ordinary rock salt) or Calcium Chloride (for colder climates). Always apply sparingly. The use of de-icing products on StoneMark, wet-cast pavers, slabs or coping may damage the product and therefore is not recommended. Whenever possible use a coarse sand as an anti-slip measure instead of de-icing chemicals.

### COLOR ADVISORY

#### 1. Selection

Due to the inherently variable nature of printed materials and digital monitors, Unilock cannot guarantee that products will match the color of printed or online images. Therefore, when making final product selections, decisions should be made based on actual stones which are readily available from Unilock, Authorized Contractors or Authorized Dealers. Most Unilock products are not comprised of a single color, but rather contain blended colors for a more natural appearance. This means that there will be significant color variance from stone to stone, so purchasers should view multiple units together to get a more accurate impression of the overall color.

*Note:* Unilock Natural Stone variations are outside the control of Unilock. Purchasers of natural stone must be willing to accept this inherent variability.

## 2. Pre-installation checking

Always check the label to ensure that the Unilock product delivered to your project is the product and color ordered. If there is a discrepancy, or if the product inside the packaging doesn't appear to be correct, contact your hardscape dealer before installing any pavers or wall units. If the product is installed, it indicates your acceptance of the products as delivered.

## 3. Blending

If the project requires more than one bundle of product it's always a good idea to draw product from several bundles when installing, as this ensures that any variation between bundles will be seamlessly integrated in the project. When bundles are from different production runs, random selection from multiple bundles is even more important.

## 4. Efflorescence

Efflorescence is a naturally occurring process that may appear as a white or light grey powder on the surface of concrete, clay or natural stone. It is temporary, and will disappear over time. However, if it is bothersome, an efflorescence cleaner can be used to remove it. There is no way to predict or prevent efflorescence. Because it does not compromise the structural integrity of the product, it is not covered by Unilock product warranties.

### INSTALLATION ADVISORY

#### 1. Construction Residue

While a certain amount of dirt on pavers and walls is inevitable during the construction phase, installers are strongly encouraged to clean as they go as construction residue can embed in the surface and become difficult to remove. The slurry produced during wet-saw cutting is particularly stubborn to clean if allowed to dry on the surface of pavers. Unilock warranties do not cover stains caused by a failure to remove construction residue.

## 2. Polymeric Haze

Surface hazing caused by polymeric jointing sand is not the responsibility of Unilock. Polymeric jointing sand should only be installed by an experienced and knowledgeable contractor. Any sand that is left on the surface prior to activation will result in a haze that is very difficult and time-consuming to remove. Only the highest quality, brand name polymeric sand that is guaranteed by the manufacturer should be used.

## 3. Compaction Damage

Both smooth and textured paver surfaces can be scratched by compaction equipment used to 'flatten' a new paver installation. Therefore, metal plate compactors must be fitted with a polyethylene mat to protect the paver surface from becoming scratched, or a superior option is to use a rubber-roller compactor instead. Damage to product surfaces caused by failure to follow these instructions is not covered by Unilock product warranties.

### FIRE PIT WARNING

Wood-burning fire pits must be lined with a proper metal insert or refractory (fire-rated) brick to protect the concrete components from extreme exposure to heat. Extreme heat on a concrete surface may affect the structural integrity of the concrete and can be dangerous. The floor of the fire pit should always be constructed using refractory brick or a sand bed. For your safety, always use a spark screen over the fire.



# Index

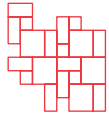

## PAVERS & SLABS

Arcana™	87
Artline™ Smooth	75
Artline Umbriano	77
Artline Il Campo	79
Beacon Hill™ Flagstone 60mm	65...12, 24
Beacon Hill™ Flagstone 80mm	67
Beacon Hill Smooth	69...14-15, 16, 23, 35, 41
Bristol Valley®	71...13, 20
Brussels Block®	51...13, 21, 22, 24, 37
Brussels Premier™	59
Copthorne®	109...29, 30, 34, 37, 38
Courtstone®	101...28, 31
Eco-Priora™	54-55
Granito™	82
Holland Premier™	57
Hollandstone™	53
Mattoni™	73
Natural Stone	91-93...41
Olde Greenwich Cobble™	52
Porcelain Tile	95
Richcliff®	97...34, 36, 39, 46
Series™	81...31
Skyline™	89
Thornbury	61...16, 28
Town Hall®	105...26, 28, 32, 37
Tribeca Cobble™	83...29
Umbriano™	85...13, 17-19, 31, 39-40
Westport™	49...22

### On the cover:

**Pavers:** Copthorne® (Basalt) walkway with Bristol Valley® (Bavarian Blend) inlay and Brussels Block® (Sandstone) accent

**Seat Wall, Pillars, Grill Island and Fire Feature:** Rivercrest (Buff) with Ledgestone™ (Buff) coping and pillar caps

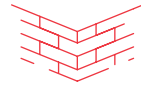

## RETAINING WALLS AND VERTICALS

Brussels Dimensional Stone®	129...13, 20, 22
Cumberland Wall™	127
Estate Wall™	125
Lineo™ Dimensional Stone	121...18-19, 22, 41
Olde Quarry™	123
PisaXL™	133
Rivercrest® Wall	119...10, 17-19, 25
SienaEdge™	131
SienaStone™	132
U-Cara®	115...15, 16, 23, 136

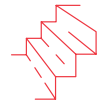

## STEPS, TREADS, COPING & CAPS

Architectural Coping & Cap	139
Brussels Fullnose™	137...20
6x12 Fullnose	137
Estate Wall™	141
Ledgestone™	136...10, 17
Natural Stone	138...32
SienaStone™	141
Siena Smooth	141
Pisa2 Coping	140
Universal Coping	140...16



## TOPICS OF INTEREST

Borders and Banding	144
Classic	44
ColorFusion™	156...85, 77, 117
Construction Process	160
Coping	138-141
Coping Pairings	158
EnduraColor™	44
Elegance™	44
EasyClean™	156...71, 75, 77, 82, 85, 87
Firepits	147...10, 14, 16, 18-19, 41
Fireplaces	147
Joint Material	161
Maintenance	164
Outdoor Idea Center	6
Outdoor Kitchens	148...14-15, 25, 39, 41
Permeable Pavers	45...54-55, 61, 63, 83, 85, 105
Pillars	150...10, 13-15, 16-19
Reala™	155...97, 101, 105, 109, 119, 136
Retaining Walls	114-133...15-16, 20, 22, 24
Sealing	161
Steps	136-141
StoneMark	45...119, 136
U-Cara Modular System	149
U-Cara Wall Mount System	151
Ultima™	155...97, 101, 105, 109
Water Features	150...10, 15, 23

Unilock Ltd. and Hengestone Holdings, Inc. are the owners or authorized users of all trademarks used in this publication unless otherwise specified. Umbriano™ are trademarks of Metten Stein + Design GmbH & Co KG used under license by Unilock®. Measurements throughout this portfolio are nominal. Not all products shown are available at all Unilock locations. Log on to [Unilock.com](http://Unilock.com) for availability. Colors shown in this catalog should be used only as a guide. Colors should always be chosen from actual samples. Contact your local Unilock representative for color availability in your area.



# Visit the Unilock Idea Center

**See + Talk + Take**

An expansive display of  
Unilock products in a  
life-size outdoor setting.

To our knowledgeable staff  
and we'll help you create a  
plan to achieve the outdoor  
space you're dreaming  
about.

**FREE samples**  
of Unilock paver and wall  
products home with you.

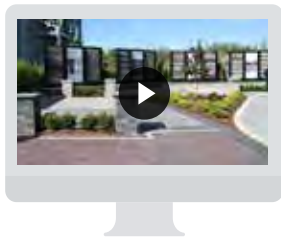

*See virtual tour at*

**Unilock.com**

Please feel free to walk around and browse our Outdoor Idea Center at any time.  
Call 1-800-UNILOCK or visit [Unilock.com](http://Unilock.com) for more details and staff hours.



# UNILOCK<sup>®</sup>

## PAVERS & WALLS

**BOSTON**  
(508) 278-4536

**CHICAGO**  
(630) 892-9191

**MILWAUKEE**  
(262) 742-3890

**KANSAS**  
(913) 417-7985

**MICHIGAN**  
(248) 437-7037

**NEW YORK**  
(845) 278-6700

**MID-ATLANTIC**  
(202) 798-2060

**ONTARIO**  
(416) 646-9000

**CINCINNATI/KY/TN**  
(513) 202-0219

**OHIO/WESTERN PA/WNY&CNY**  
(330) 927-4000