



I-800-848-6166
www.superiorclay.com



Superior Clay Corp. Masonry Fireplaces

Superior Clay Corporation produces designs and components for masonry fireplaces in a complete range of styles or sizes. Superior Clay and our over 800 dealers provide technical support using 800 toll free telephone and fax service.

Fireplace designs are available for Rumford or Standard Fireplace designs as well as see-thru, Kiva and triangular design.

Also in this catalog are decorative elements for fireplaces and chimneys such as Decorative Chimney Tops, Victorian Tiles, Herringbone Fireboxes and Mantels.

Superior Clay is your source for masonry fireplace components, if you can't find it, call us, chances are we can help.

To order call 1-800-848-6166 or visit our web site at <http://www.superiorclay.com>

*Fireplace by Buckley Rumford -
Components from Superior Clay*

This Rumford Fireplace was one of two Rumfords in the award winning home featured in the Ft. Worth Texas Street of Dreams. The home was built by Fred Parker Company Inc, Ft. Worth, Texas.

Tried & Tested for over 200 years.

Rumford Fireboxes.

Rumford fireplaces have a long, rich history. Designed by Count Rumford, noted scientist and inventor, the Rumford fireplace is tall and shallow with steeply angled side walls and an elegant curved throat. This design radiates more heat into the room, minimizes loss of heated air up the chimney and burns cleanly.

Rumford fireplaces were quite common during the 1800's. In fact, they were used by Thomas Jefferson when he built Monticello and mentioned by Henry David Thoreau as one of the modern conveniences we take for granted.



A Rumford Fireplace complements any decor.



Today Rumford fireplaces are easy to install using Superior Clay's line of Rumford components backed up by our excellent technical support and our comprehensive website at www.superiorclay.com.

Superior
Clay Corporation

The logo for Superior Clay Corporation features a stylized illustration of a brick being laid by a trowel. The word "Superior" is in a serif font, "Clay" is in a larger, bold serif font, and "Corporation" is in a smaller serif font. The background of the logo area has a herringbone pattern.

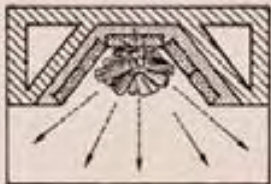

Radiant Heat

Tall and elegant, a Rumford fireplace is a very effective radiant heater. The tall shallow firebox with widely splayed side walls radiates more heat into the room.



Streamlining

Rumford streamlined the throats, or in his words “rounded off the breast” to remove those local hindrances that forcibly prevent the smoke from following its natural tendency to go up the chimney. With an intuitive understating of fluid dynamics far beyond the science of his day, Rumford created a venturi nozzle that propels the smoke and air up the chimney. By eliminating turbulence the air stream is much easier to control, and the throat opening can be reduced for maximum efficiency.

Clean Burning

The straight back and streamlined throat have a beneficial effect that Count Rumford could never have imagined, by keeping the smoke hotter further up the chimney, more particulate is burned, making Rumfords the only clean burning traditional fireplaces. Rumfords have been lab tested and meet wood burning appliance emission regulations.

Decorating

The beauty of masonry is in the infinite choices of decorating the fireplace and chimney. As with any fireplace, Rumfords can be decorated with any method and material that meets building codes. Deep surrounds block some radiant heat, and the surround should never drop below the leading edge of the throat. No matter how you decorate, you will still have an efficient heating fireplace.

Sizing

24" and 30" are ideal for dens, bedrooms of less than 200 square feet and conversions of Victorian coal or gas burning fireplaces. 36" and 42" Rumfords are suited to living rooms, dining rooms, and family rooms of 200 to 400 square feet. 48" Rumfords are for use in large rooms with tall ceilings, or as Rumford would say “Great Halls.” Fireplaces larger than 48" are often used in lobbies, and lodges with large open spaces.

Rumford Fireplace

...Components by Superior Clay Corp.

Tall and elegant... the fireplace that keeps you warm. Rumford fireplaces are shallow to reflect more heat and have streamlined throats to eliminate turbulence and carry away the smoke with little loss of heated room air.

By using Superior Clay Rumford fireplace components you can be sure that all the critical ratios are engineered for you so the fireplace will be efficient and draw well. The builder or mason need only follow the instructions that come with the components to guarantee quality, save time and ensure the correct Rumford design.

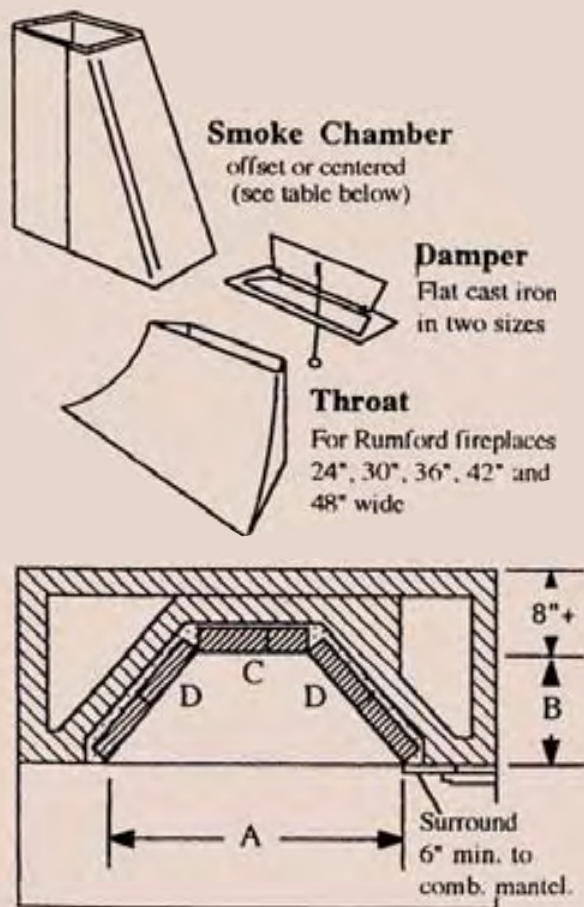
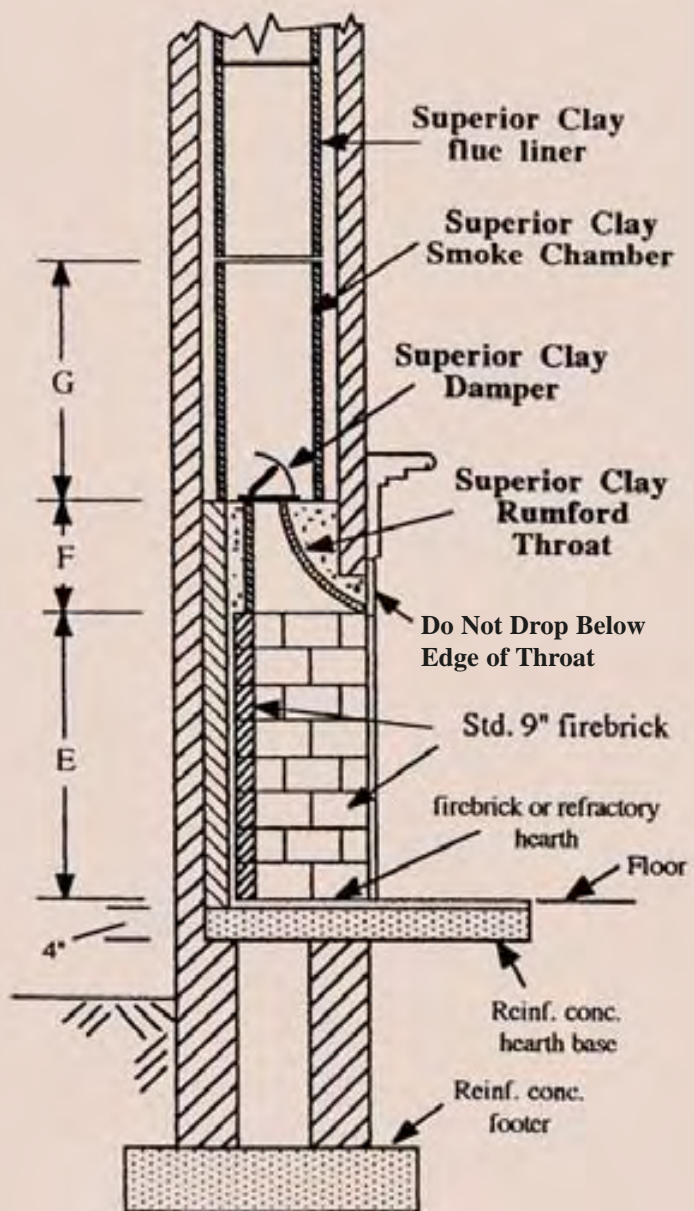

Rumford Fireplaces by Superior Clay

FIREPLACE SIZE	THROAT (A x F)	DAMPER (Frame)	SMOKE CHAMBER (Base x G)	FLUE TILE	OTHER DIMENSIONS:						
					A	B	C	D	E	F	G
24" wide	24" x 12"	5.5" x 18"	8.5" x 24" x 19"	8.5" x 13"	24"	12"	13.5"	13.5"	24"-28"	12"	19"
30" wide	30" x 12"	9" x 24"	13" x 30" x 18"	13" x 13"	30"	12"	13.5"	15"	28"-32"	12"	18"
36" wide	36" x 14"	9" x 24"	13" x 30" x 18"	13" x 13"	36"	14"	13.5"	18"	32"-38"	14"	18"
42" wide	42" x 15"	9" x 30"	13" x 34" x 19"	13" x 18"	42"	15"	15"	21"	38"-42"	15"	18"
48" wide	48" x 16"	9" x 30"	16" x 36" x 19"	16" x 20"	48"	16"	18"	22.5"	42"-48"	16"	18"

Rumford Fireplace Components . . .

make building a masonry Rumford fireplace easy for any mason. We do the design work. All you do is build the firebox out of fire brick, set the throat, damper and smoke chamber, bringing the masonry up as you go, set the first flue tile and complete the chimney and you have built the highest quality of all masonry fireplace since 1796.

By using these Rumford fireplace components you can be sure that all the critical ratios (depth-to-width, throat-to-fireplace opening, smoke chamber and flue size) are engineered for you so the fireplace will be efficient and draw well. The builder or mason need only follow the instructions that come with the components to guarantee quality, save time and ensure the correct Rumford design.



Throat



Damper



Smoke Chamber

RECOMMENDED SPECS			
Fireplace Width	Throat Size	Damper Dimensions	Smoke Chamber
24"	24"	5.5" x 13"	8.5" x 18"
30"	30"	9" x 24"	13" x 13"
36"	36"	9" x 24"	13" x 13"
42"	42"	9" x 30"	13" x 18"
48"	48"	9" x 30"	16" x 20"

Note: Other smoke chamber sizes can be substituted when appropriate. Designs and component lists for other sizes are available at our web site or by calling us at 800-848-6166.



Installation of the Rumford Fireplace ...

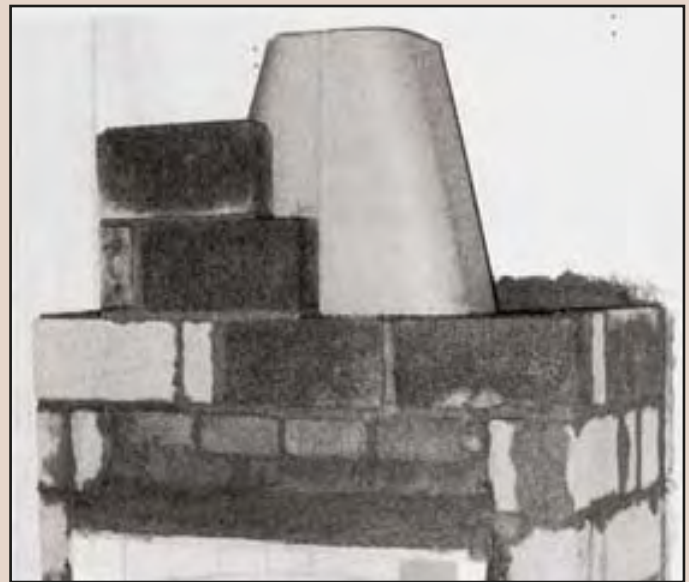
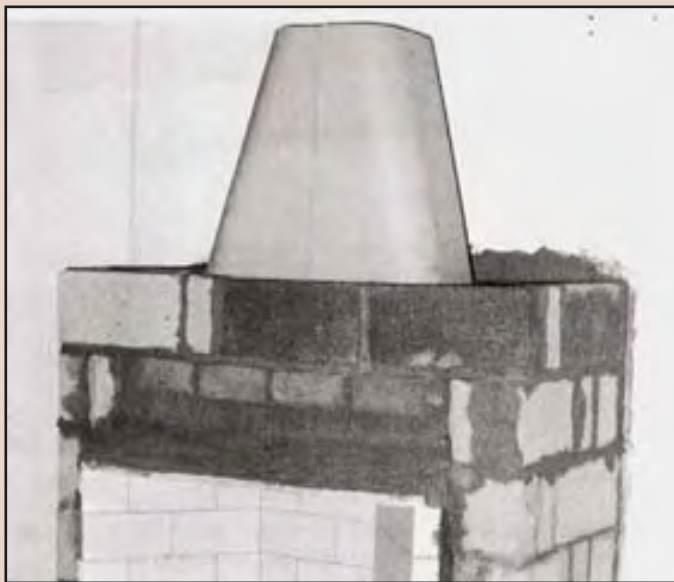
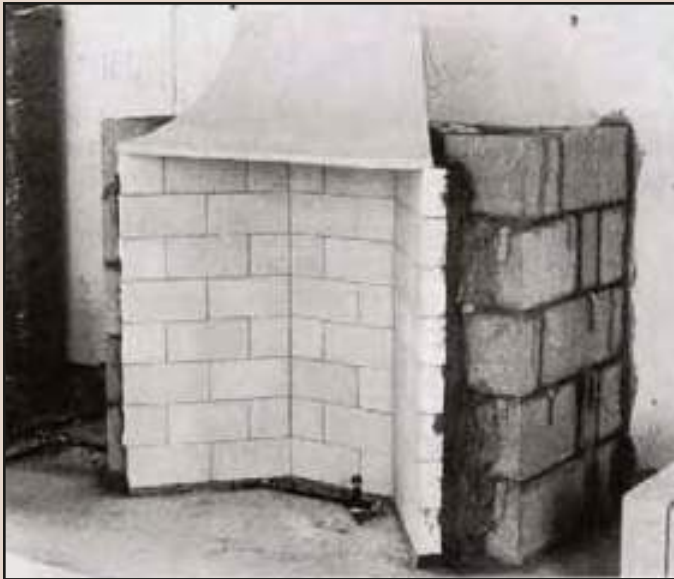

Four easy steps to build a Rumford Fireplace

1. Build the Rumford Firebox with 9" standard firebrick laid with minimum joints using refractory mortar. The firebrick should be backed up with solid masonry to make the firebox walls at least 8" thick.
2. Set the curved Rumford throat in the refractory mortar on the top of firebox and lay up the surrounding masonry to the top of the throat.
3. Set the cast iron damper in position over the throat opening.
4. Set the smoke chamber over the damper, making sure that the damper will open and close freely. Lay up surrounding masonry at least 4" thick around it. You are now ready to set the flue tiles in place and continue the chimney upward to the desired height. Complete the job with a beautiful Superior Clay Chimney top.

Making Rumford Fireplaces Deeper

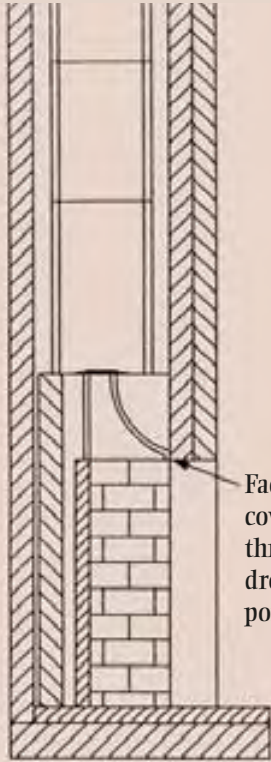

Count Rumford and Jim Buckley would argue that you should never make fireplaces deeper than we show on our chart on page 4 because this is the approximate depth Count Rumford determined, through experimentation, to provide optimum transfer of radiant heat. As Jim would say, "It's like putting a lawn mower engine in your Jaguar."

However, if you have to have a deeper firebox, as long as you bring the face straight into the room and don't drop below the curved throat with your lintel, the fireplace will work fine.

Facing just to cover edge of throat. Do not drop below this point.

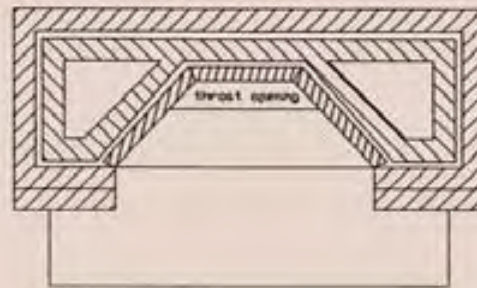

Arched Fronts

For arched fronts the same rule applies. Don't drop the lintel down below the curved throat, as this creates turbulence. Put the high point of the arch at the same elevation as the leading edge of the curved throat.

Facing just to cover edge of throat. Do not drop below this point.

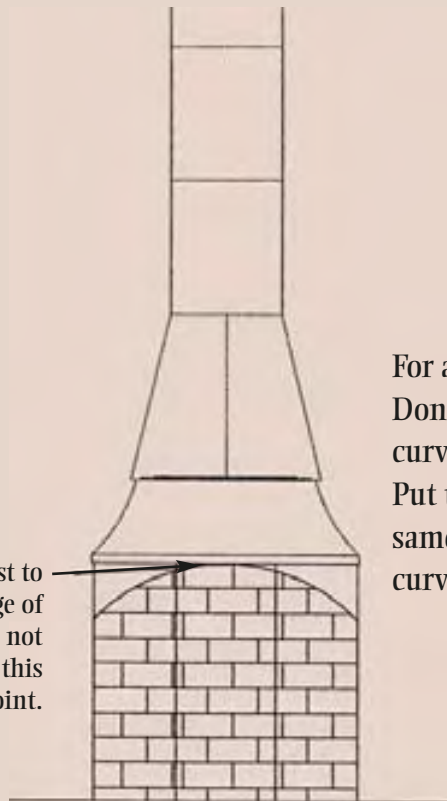

Large or Modified Rumford Fireplace

...Based on the principles of the legendary Count Rumford

**Tall and elegant...
the fireplace that keeps you warm.**

Rumford fireplaces have shallow fireboxes to reflect more heat and have streamlined throats to eliminate turbulence and carry away the smoke with little loss of heated room air.

By using Superior Clay fireplace components, you can be sure that all the critical ratios are engineered for you so the fireplace will be efficient and draw well. The builder or Mason need only follow the instructions that come with the components to guarantee quality, save time and ensure the correct design.

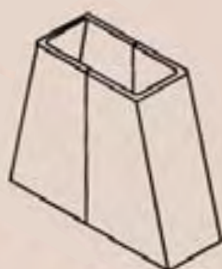
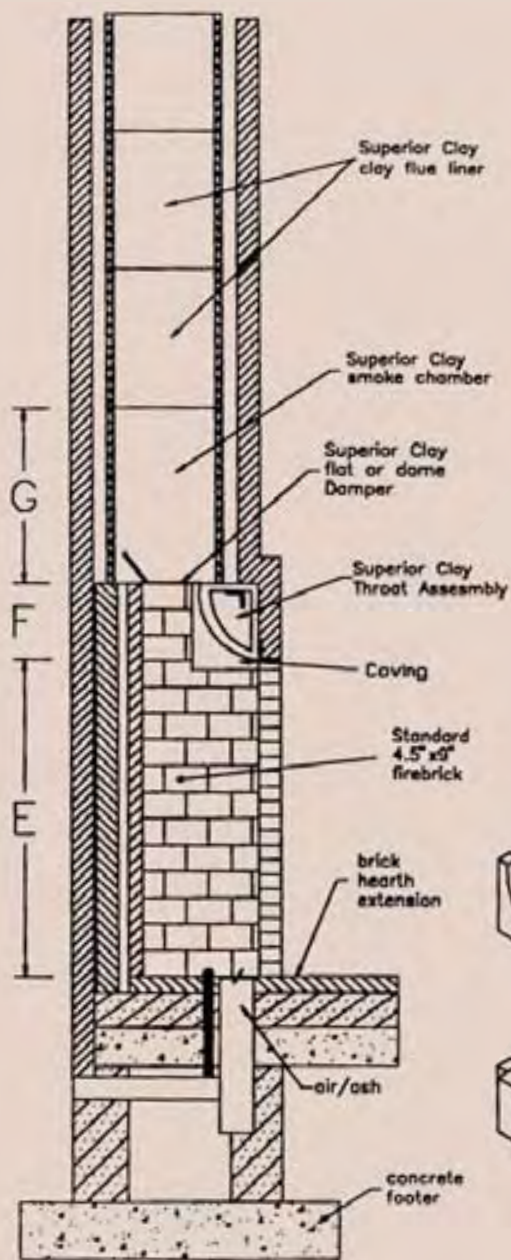

Smoke Chamber

Offset or centered
(see table below or pg. 17)



Damper

Cast iron or steel

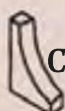

Coving

Fits the curve of the throat tiles

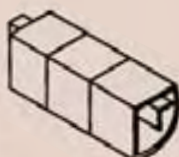

Superior Clay Throat Tiles

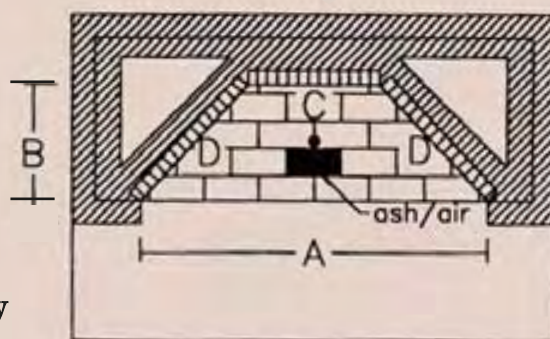

Rumford Fireplaces by Superior Clay

FIREPLACE SIZE	THROAT (DEPTH X WIDTH)	DAMPER SIZE	SMOKE CHAMBER (Base x G)	FLUE SIZE	OTHER DIMENSIONS						
					A	B	C	D	E	F	G
36" wide	4" x 17"	20" x 4"	13" x 30" x 18"	13" x 13"	36"	14"	13.5"	18"	32" - 36"	13.5"	18"
42" wide	4.5" x 20"	23.5" x 4.5"	13" x 34" x 19"	13" x 18"	42"	15"	15"	21"	38" - 42"	13.5"	18"
48" wide	5" x 23"	27.5" x 5"	16" x 36" x 19"	16" x 20"	48"	16"	18"	22.5"	42" - 48"	13.5"	19"
60" wide	10" x 27"	10" x 42"	20" x 50" x 30"	20" x 20"	60"	20"	22.5"	27"	45" - 54"	13.5"	30"
72" wide	10" x 34"	10" x 48"	24" x 57" x 30"	24" x 24"	72"	24"	27"	31.5"	45" - 60"	13.5"	30"

Dome - style damper with modified handle

Building the Large or Modified Rumford

Superior Clay Corporation masonry Rumford fireplaces are designed to help you build the best fireplaces available - systematically, quickly and profitably.

Build the Rumford Firebox backed up with solid masonry to the top of the opening. Continue to lay block 12.5" above the opening to support the angle which carries the throat sections.

Set the throat and continue to build the firebox and surrounding masonry being careful to get the correct throat opening depth. Then cover the throat opening with the damper, set the smoke chamber and surround it with masonry and start stacking flues for the chimney.

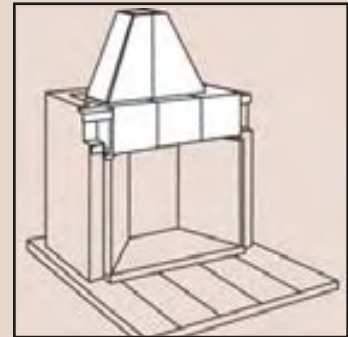
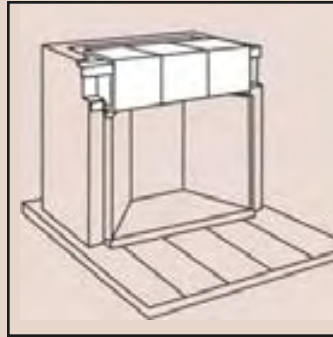
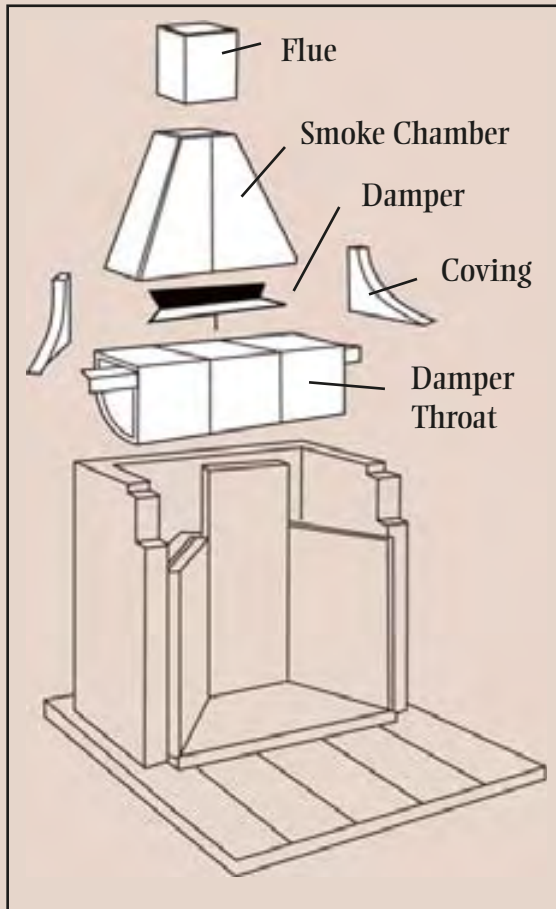

RECOMMENDED SPECS					
Fireplace Width	Throat Sections	Coving Section	Min. Damper Throat	Damper Frame	Smoke Chamber
36"	3	1 Left, 1 Right	20" x 4"	9" x 24"	13" x 13"
42"	3.5	1 Left, 1 Right	23.5" x 4.5"	9" x 30"	13" x 18"
48"	4	1 Left, 1 Right	27.5" x 5"	9" x 30"	16" x 20"
60"	5	1 Left, 1 Right	10" x 42"	42" dome	20" x 20"
72"	6	1 Left, 1 Right	10" x 48"	48" dome	24" x 24"

Note: Designs and component lists for other sizes are available at our web site or by calling us at 800-848-6166.

Smoke chambers are available either straight or offset for all sizes.

The Certified Core

Lab Tested Clean Burning Rumfords

Rumford Fireplaces that have been tested and certified to meet emissions standards are available as core kits. All Rumfords are clean burning, however to meet certain indoor air and efficiency requirements in some areas doors and air intakes are included in the cores. If you are required to have an approved clean burning fireplace specify the "Rumford Certified Core."

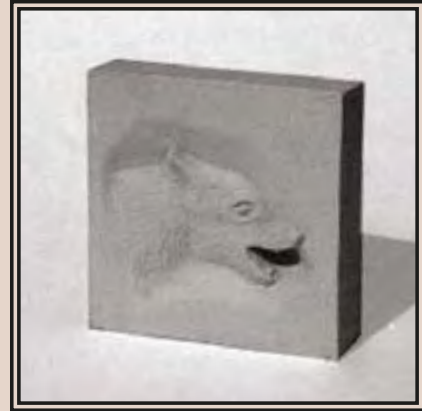

Air Intake

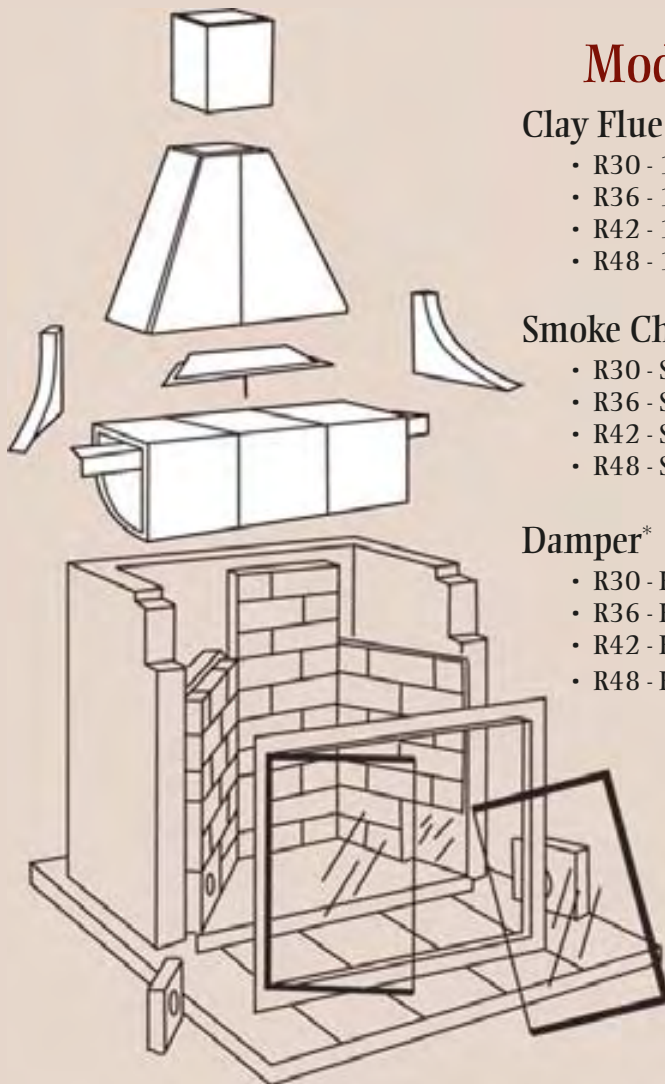

Models: R30, R36, R42 and R48

Clay Flue Liners

- R30 - 12" x 12"
- R36 - 12" x 16"
- R42 - 16" x 16"
- R48 - 16" x 20"

Smoke Chamber*

- R30 - Superior Clay SC1212
- R36 - Superior Clay SC1216
- R42 - Superior Clay SC1616
- R48 - Superior Clay SC1620

Damper*

- R30 - K & W 1730 ss
- R36 - K & W 1736 ss
- R42 - K & W 1742 ss
- R48 - K & W 1748 ss

Throat*

- R30 - Superior Clay TS30
- R36 - Superior Clay TS36
- R42 - Superior Clay TS42
- R48 - Superior Clay TS48

Firebox*

- R30 - 70 std 9" Firebrick
- R36 - 80 std 9" Firebrick
- R42 - 100 std 9" Firebrick
- R48 - 120 std 9" Firebrick

Refractory Mortar

- R30 - one 15# pail Heatstop
- R36 - one 15# pail Heatstop
- R42 - two 15# pails Heatstop
- R48 - two 15# pails Heatstop

FrischAir Door System*

- R30 - FA30
- R36 - FA36
- R42 - FA42
- R48 - FA48

The Principles of Good Fireplace Design

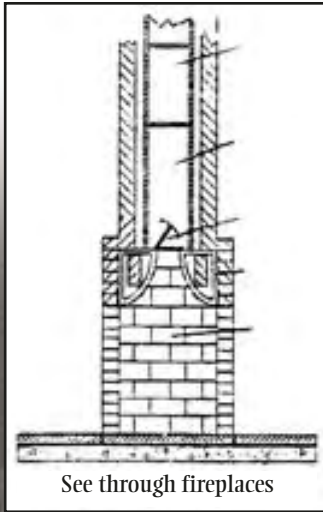

1. Larger front faces and proper angles at back wall radiate more heat into room.
2. Curved throats create good laminar air flow in the fireplace.
3. Smaller throat openings draw less heated room air up the chimney. Superior Clay fireplaces typically have smaller throat openings because curved throat sections eliminate turbulence and prevent smoking.

The principles of good fireplace design can be applied to any type of fireplace.

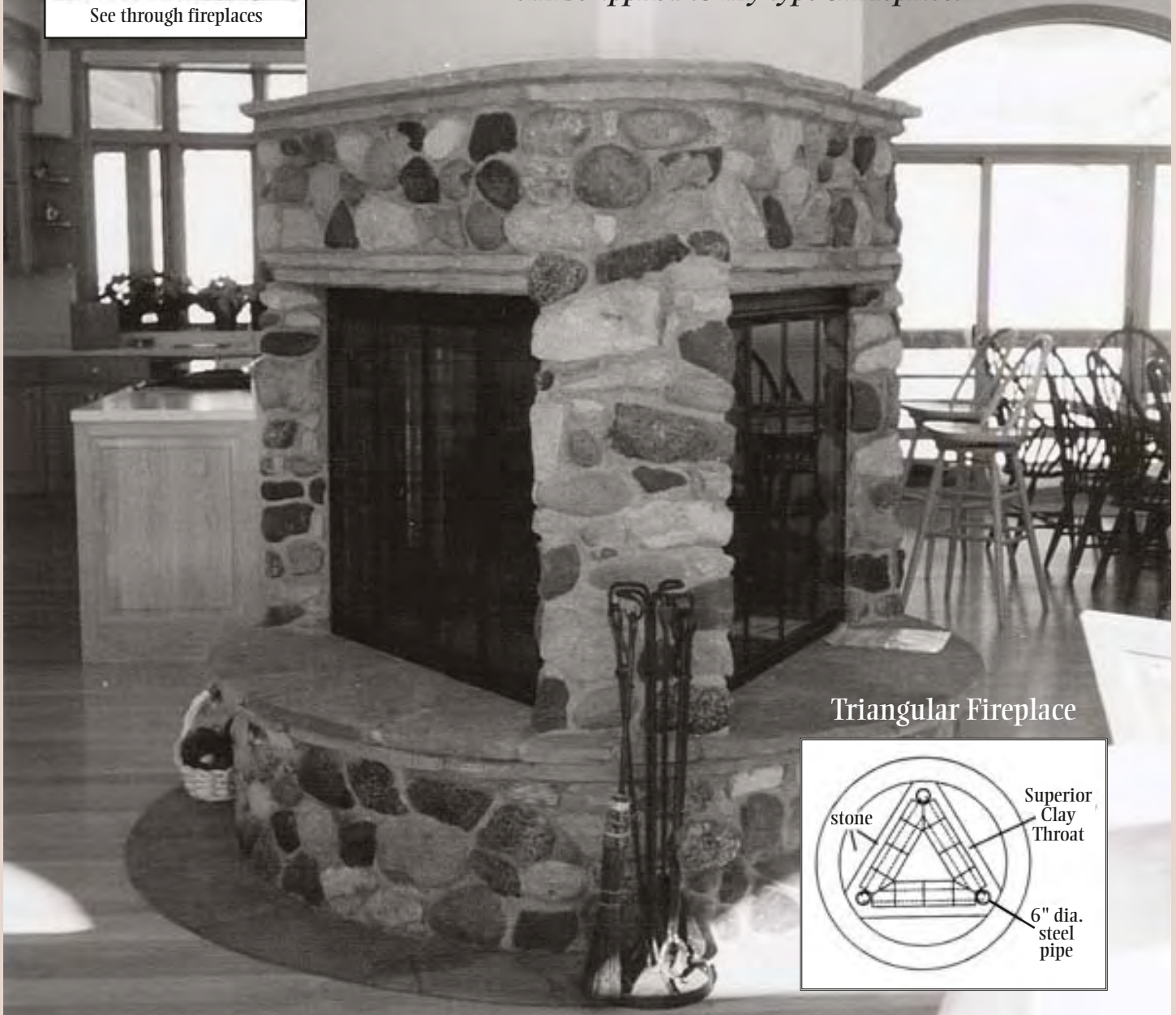

Triangular Fireplace

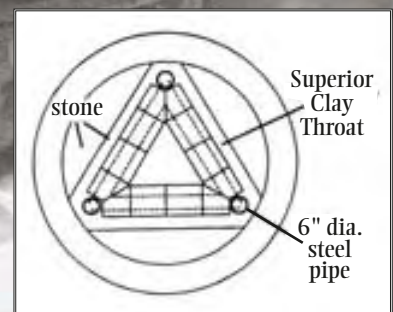

He's really not two feet tall... this is a big fireplace!

One of the largest Rumfords ever built is this ten foot wide beauty built by Martin Barnes of Bow, Washington. (pictured on the mantel)



Arched Openings

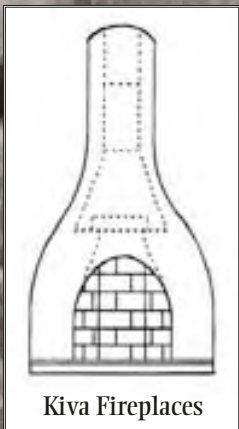

Kiva Fireplaces

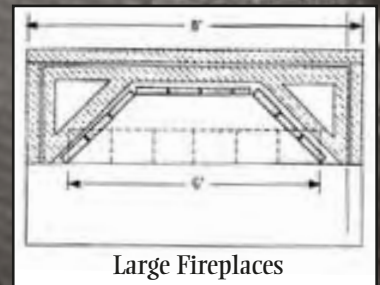

Large Fireplaces

Stacked Rumford Fireplaces

Building fireplaces that share a chimney and foundations is a good way to cut the cost of masonry fireplaces. For example, a 30" fireplace upstairs in a bedroom would only add the cost of a firebox and a few flue liners. Any additional cost to the chimney or foundation would be minimal. Adding flues to the chimney stack is an economical way to vent other appliances like furnaces or hot water tanks.

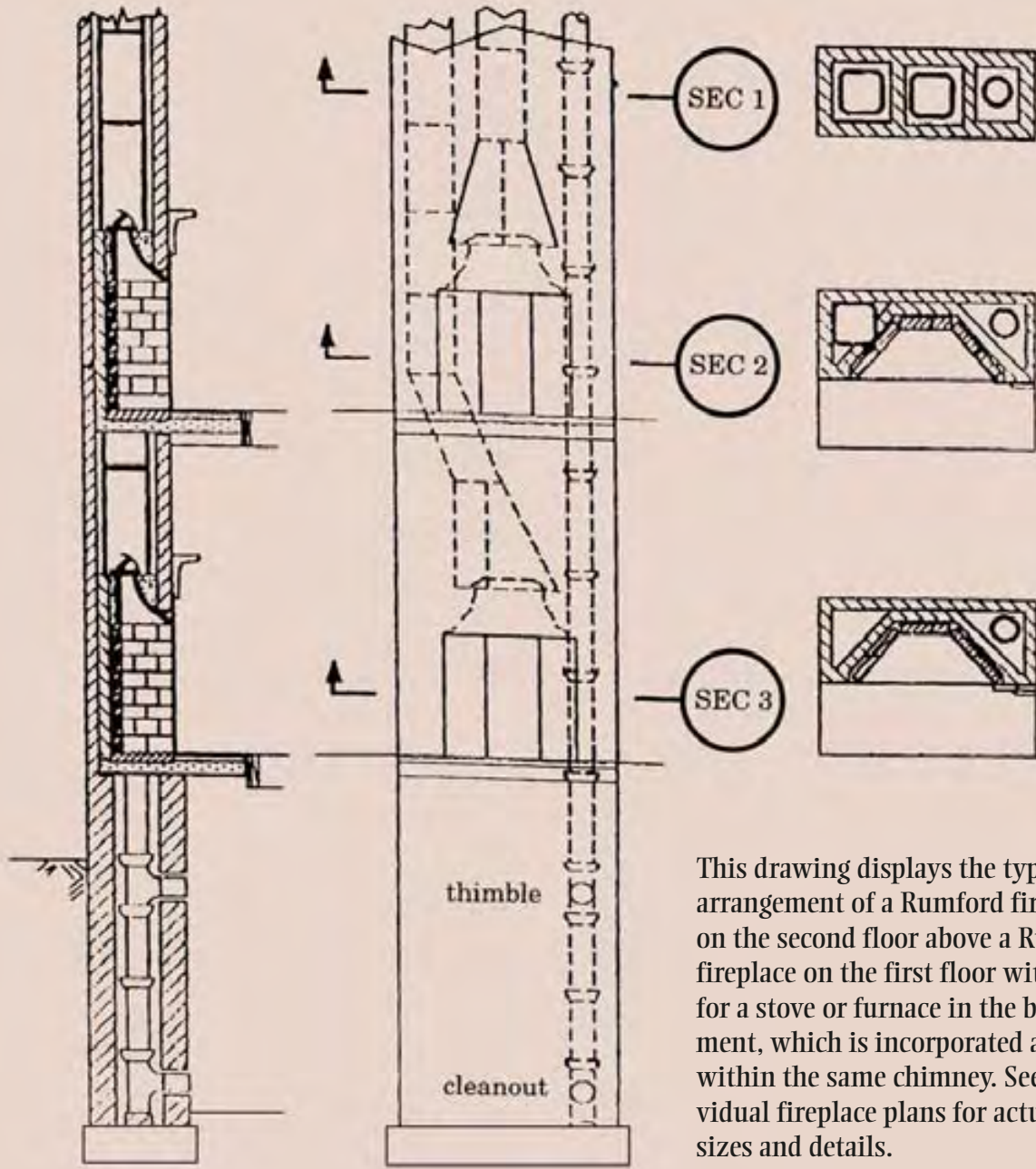

This drawing displays the typical arrangement of a Rumford fireplace on the second floor above a Rumford fireplace on the first floor with flues for a stove or furnace in the basement, which is incorporated all within the same chimney. See individual fireplace plans for actual sizes and details.

The Kiva-Rumford

...Two Great Traditions in One Fireplace

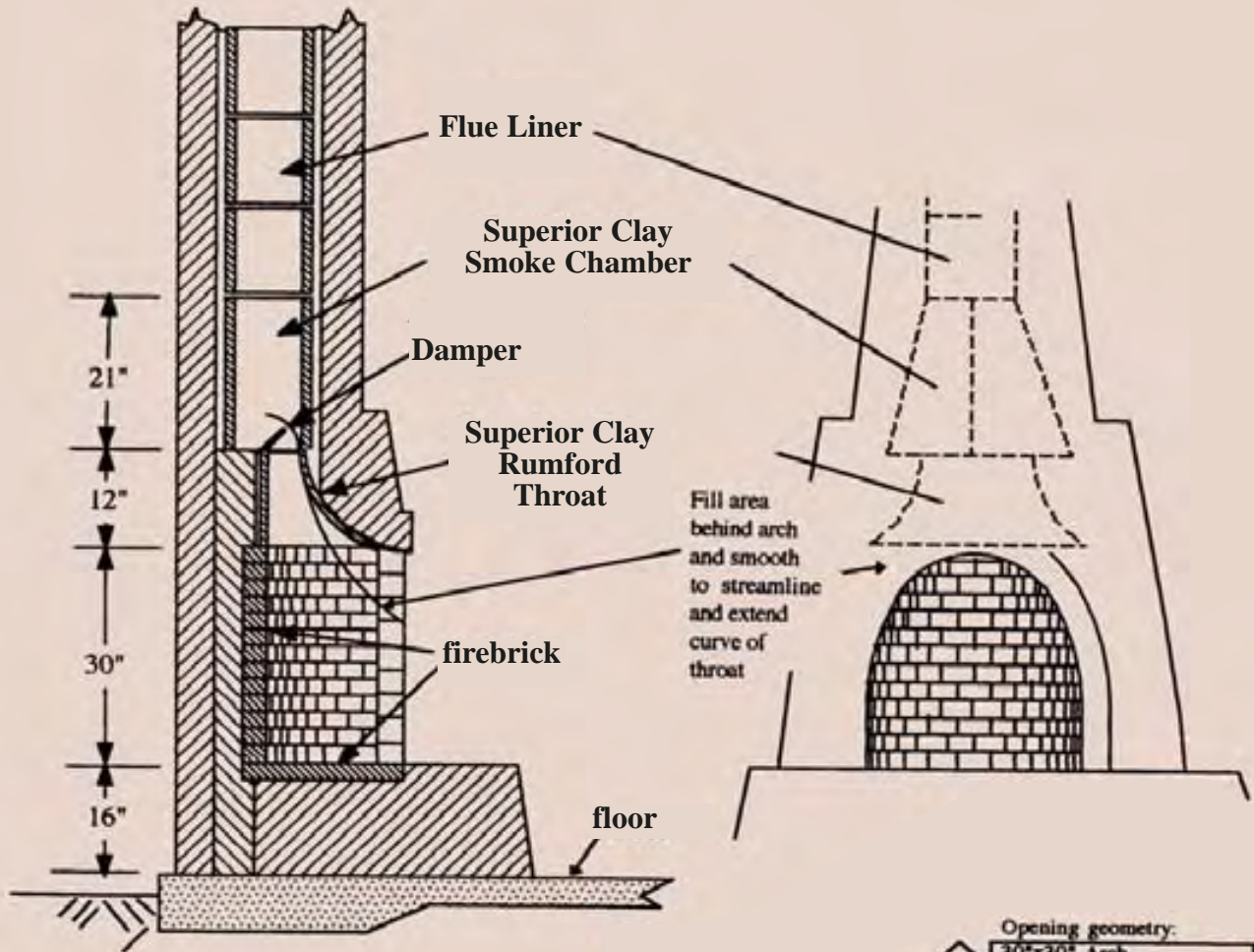

The Superior Clay all masonry Rumford fireplace system is fully integrated with an all masonry or adobe Wall System. The two systems work together. There are no complicated “distance to combustible” code rules to follow if you don’t build with combustibles. Safer, longer lasting and more energy efficient, an all masonry traditional Rumford fireplace works best in an all masonry home.

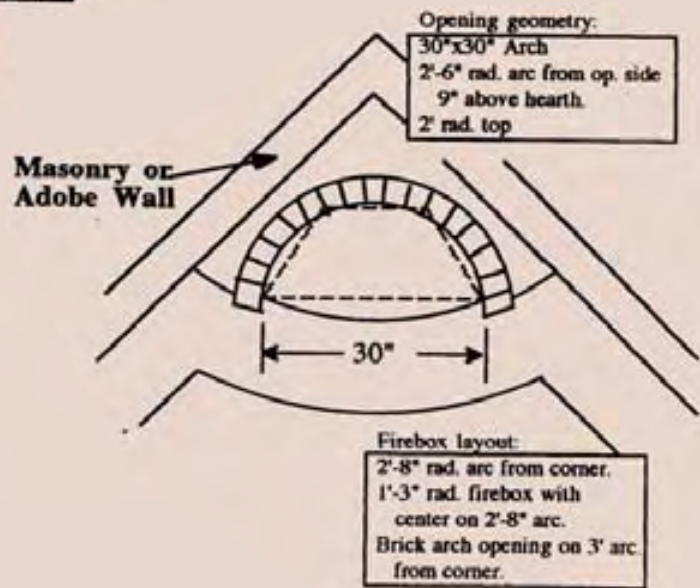

Distinct in design



Dark Red

Red

Ivory

Gold

Herringbone Fireboxes

The distinctive Herringbone pattern fireboxes that adorn palaces and castles throughout Europe are available pre-panelized for Superior Clay Rumford Fireplaces. Real firebricks, available in a variety of colors, are laid in the Herringbone pattern and bonded to reinforced concrete forming a 5-inch thick panel. The Herringbone panels are installed by the mason during construction of the fireplace to create a beautiful focal point for any room.



Herringbone Fireboxes

Superior Clay Herringbone pattern fireboxes can be customized by choosing the size of exposed firebrick face, by selecting the color or blending of colors or by creating your own variation of patterns. The exposed firebrick face most commonly used is 1 $\frac{1}{4}$ " x 9", which creates a thin, elegant coursing with lots of joints.

The 2 $\frac{1}{2}$ " x 9" or 4 $\frac{1}{2}$ " x 9" faces offers a bold and less busy appearance. The firebox floor, or hearth, can either be installed by the mason prior to the installation of the Superior Clay pre-panelized Herringbone walls or ordered separately from Superior Clay in the Herringbone pattern.

Installation Instructions

Herringbone fireplace fireboxes built by Superior Clay Corporation are faced with 9" x 1 $\frac{1}{4}$ " firebrick in a vertical Herringbone pattern. The fireboxes are shipped in three sections - two covings and the fireback (inner hearths are also available) and are easily erected at the job site. The pre-made fireboxes save master masons much time and aggravation and allow less experienced masons to build beautiful Herringbone fireboxes.

- (1) The mason lays the inner hearth, level and centered, in a bed of mortar.
- (2) The next day, the covings and the fireback are set in place, in the refractory mortar provided, on the hearth. They are temporarily supported with concrete blocks or lumber.
- (3) A solid masonry-backing wall at least four inches thick is built to permanently support the firebox.
- (4) Refractory mortar is used to fill any cracks between the four pieces of the firebox and the firebox is washed with clean water.
- (5) Now the firebox is ready to be treated like any other - carefully - until the solid masonry has cured.

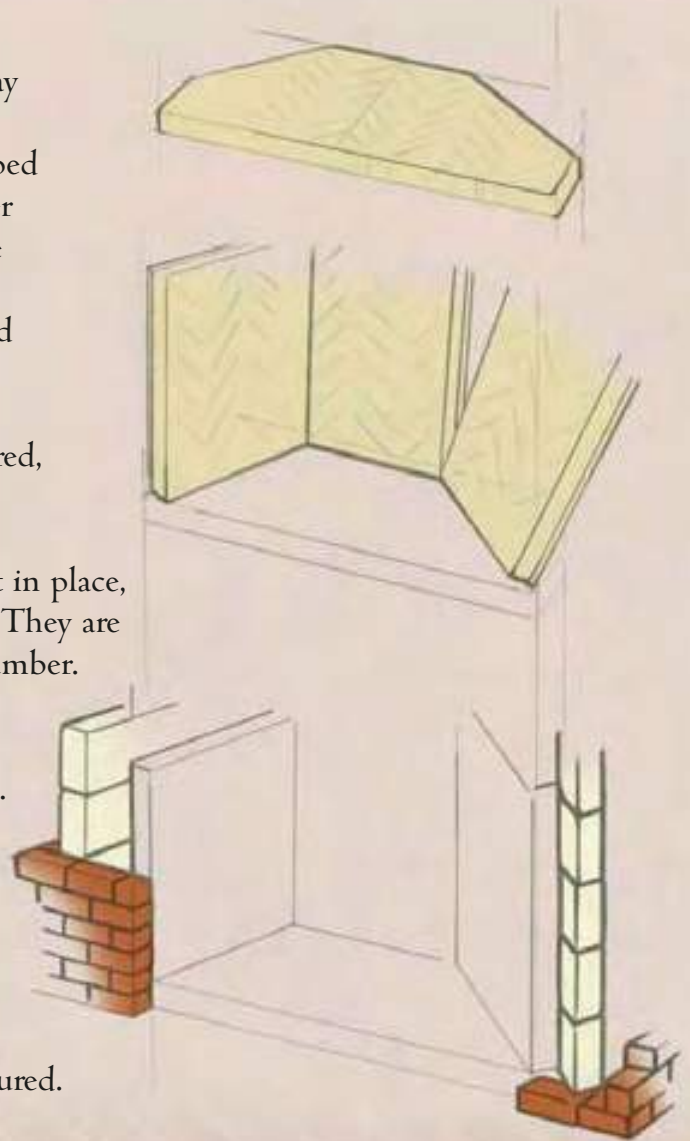

Herringbone Firebox Weights

36" - 1165 lb	60" - 2000 lb
42" - 1645 lb	72" - 3600 lb
48" - 1894 lb	



Make your chimney a focal point

Whether you aspire to recreate the feel of the Victorian era or want to finish your chimney with the clean simple lines of a classic chimney pot, Superior Clay can help. With more than 45 standard styles to choose from, we can also create custom designs to ensure you achieve the look you desire.



Superior
Clay Corporation

www.claychimney pots.com

Old World Craftsmanship

Every one of our chimney pots are handmade by skilled craftsmen. The technique, handed down from generation to generation, starts with blending our clays. Next the clay is molded into the chimney pot shape, the pot is hand finished, then dried and carefully fired in our kilns to approximately 2000° F. The result is a unique architectural element you will be proud to add to your home.



Clay Chimney Pots



Make your chimney a focal point



Selecting Chimney Pots



W

hen selecting a chimney pot that will function properly it is important to consider the top opening in relation to the fireplace opening, and the base dimensions in relation to the flue they are covering. The top opening should be in ratio to the fireplace opening. The chimney pot opening is often smaller than the effective area of the flue liner in order to reduce the effect of wind on the draft. Flue area is typically about $\frac{1}{10}$ the fireplace opening area for square flues and about $\frac{1}{12}$ for round flues. For chimney pots this ratio is often reduced to $\frac{1}{15}$ - $\frac{1}{20}$. The base inside dimension and the base outside dimension should be nearly as large or larger than the largest dimension of the

flue they are being installed on. The base of the chimney pot should not impinge on the effective area of the flue by more than $\frac{3}{4}$ of an inch. Many other factors such as fireplace chimney construction and house air pressure can affect proper chimney operation.

Camelot ▲

33" Tall

Fairmont ★

59" Tall

8½ x 13 Peerless ■

28" Tall

Cannon Barrel ★

31" Tall

Beacon ▲

36" Tall



Belmont ■
35" Tall



8 1/2 x 8 1/2 Classic ○
22" Tall



Anchor Bonnet ○
28" Tall



Bishop ■
30" Tall

King Arthur ☆
33" Tall

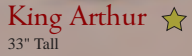

◇ 18 x 18 Diamond
30" Tall

◇ 18 x 18 Peerless
30" Tall



○ Birdcage
18" Tall

○ 8 1/2 x 8 1/2 Cathedral
22" Tall

Installation

Chimney pots are set in a bed of mortar on the masonry chimney cap. The base of the chimney pot need not match the dimensions of the flue liner it is being installed on top of, but should not impinge on the inside area of the flue liner except for the maximum ³/₄ of an inch in the corners. The flue liner may extend up inside the chimney pot, or the flue liner may be flush with the top surface of the chimney cap. Additional anchoring may be used to prevent damage from tornadoes, hurricanes or earthquakes. A ¹/₄ - ¹/₂ inch diameter hole may be drilled in at least two opposite sides of the chimney pot and a bar used to anchor the top into the grout or the chimney walls. When installing on wood chase chimneys, special attention should be given to preventing water leakage around the base of the chimney pot.

○ Colonial
18" Tall

○ Mini Windsor
18" Tall

○ Queen Anne
18" Tall



○ Mini Edwardian
18" Tall

○ Chimney Base
13" Tall



☆ Essex
12" Tall

○ Mini Hampshire
18" Tall

☆ Large Edwardian
36" Tall



Sizing Key

- 8"
- 24"
- ▲ 30"
- ☆ 36"
- ◆ 42"
- ◇ 48"
- ◐ 60"
- ✖ 72"

Circle indicates pots used to vent appliances with a maximum flue diameter of 8". Shapes indicate the maximum opening width for single-face fireplaces.





Monarch
36" Tall

Windsor ☆
32" Tall

Duchess ◐
32" Tall

✦ 24 x 24 Classic
24" Tall

◈ 18 x 18 Classic
24" Tall

Small Mansard ☆
13" Tall

Wellington ✦
26" Tall

◻ Governor
32" Tall

◻ Devonshire
36" Tall

▲ Edwardian
35" Tall

▲ Austen
36" Tall

▲ Austen EX
50" Tall

● 8 1/2 x 8 1/2 Diamond
27" Tall

☆ Baron
32" Tall

☆ Large Kensington
32" Tall

◻ Small Kensington
30" Tall

▲ Willow
34" Tall

◐ Imperial
82" Tall

☆ Virginian
24" Tall

☆ Victorian
25" Tall

◐ Empress
36" Tall

✦ Sherwood
28" Tall

✦ Archduke
30" Tall

✦ Nottingham
28" Tall

✦ Vanguard
30" Tall

Sizing Key

- 8"
- ◻ 24"
- ▲ 30"
- ☆ 36"
- ◈ 42"
- ◈ 48"
- ◐ 60"
- ✦ 72"

Circle indicates pots used to vent appliances with a maximum flue diameter of 8".
Shapes indicate the maximum opening width for single-face fireplaces.





STYLE	HEIGHT	WEIGHT	TOP OPENING	BASE I.D.	BASE O.D.	
Anchor Bonnet	28"	78	(2) 7 1/2"	11 1/4"	12 1/2"	○
Archduke	30"	366	19 1/4"	24"	27"	✘
Austen	36"	138	8 1/4"	12"	14 1/2"	▲
Austen EX	50"	175	8 1/4"	12"	14 1/2"	▲
Avon	31"	225	11 1/4"	14 1/2" x 14 1/2"	17 3/4" x 17 3/4"	☆
Baron	32"	125	9 1/2"	13 1/2" x 13 1/2"	15 3/4" x 15 3/4"	☆
Beacon	36"	125	6 3/4"	12"	14 1/2"	▲
Belair	29"	160	(2) 7 1/2" x 9"	12 1/2"	16"	☆
Belmont	35"	110	(2) 6 1/2" x 7"	11 1/4" x 11 1/4"	13 1/4" x 13 1/4"	■
Bird Cage	18"	37	(4) 3 1/2" x 6 1/2"	11 3/4"	13"	○
Bishop	30"	115	8 1/4"	10 1/2" x 10 1/2"	13 1/4" x 13 1/4"	■
Camelot	33"	160	7 1/2"	13"	15"	▲
Cannon Barrel	31"	132	11 1/2"	18 1/4"	20"	☆
Cathedral Style						
8 1/2 x 8 1/2 Cathedral	22"	25	(4) 4 1/2" x 4 1/2"	7" x 7"	8 1/2" x 8 1/2"	○
8 1/2 x 13 Cathedral	22"	32	(2) 4 1/2" x 4 1/2"	7" x 11 1/4"	8 1/2" x 13"	■
			(2) 6 3/4" x 6 3/4"			
13 x 13 Cathedral	23"	42	(4) 6" x 6"	11 1/4" x 11 1/4"	13" x 13"	☆
13 x 18 Cathedral	32"	90	(2) 6" x 6"	11" x 15 1/2"	13" x 18"	◆
			(2) 8 1/2" x 8 1/2"			
18 x 18 Cathedral	32"	125	(4) 9" x 9"	16" x 16"	18" x 18"	⬡
Chimney Base	13"	44	6 3/4"	9 3/4" x 9 3/4"	11 1/2" x 11 1/2"	○
Classic Style						
8 1/2 x 8 1/2 Classic	24"	35	4 3/4" x 4 3/4"	7" x 7"	8 1/4" x 8 1/4"	○
8 1/2 x 13 Classic	24"	48	6 1/2" x 6 1/2"	7" x 11 1/2"	8 1/2" x 13"	■
13 x 13 Classic	24"	58	7 1/2" x 7 1/2"	11 1/4" x 11 1/4"	13" x 13"	☆
13 x 18 Classic	24"	93	10" x 10"	11" x 16"	13" x 18"	◆
18 x 18 Classic	24"	126	10 1/2" x 10 1/2"	16" x 16"	18" x 18"	⬡
20 x 20 Classic	24"	168	11 1/2" x 11 1/2"	17 1/2" x 17 1/2"	20" x 20"	●
24 x 24 Classic	24"	260	15" x 15"	21" x 21"	24" x 24"	✘
Colonial	18"	65	8 1/4"	10"	12 1/2"	○
Devonshire	36"	95	7"	11 1/4" x 11 1/4"	13 1/4" x 13 1/4"	■
Diamond Style						
8 1/2 x 8 1/2 Diamond	27"	41	(4) 4 1/2" x 4 1/2"	7" x 7"	8 1/2" x 8 1/2"	○
8 1/2 x 13 Diamond	27"	54	(2) 5 1/2" x 5 1/2"	7" x 11"	8 1/2" x 13"	■
			(2) 6" x 6"			
13 x 13 Diamond	28"	75	(4) 7" x 7"	11 1/2" x 11 1/2"	13 1/4" x 13 1/4"	☆
13 x 18 Diamond	29"	125	(4) 7" x 7"	11" x 16"	13" x 18"	◆
18 x 18 Diamond	31"	175	(4) 8 1/2" x 8 1/2"	16" x 16"	18 1/4" x 18 1/4"	⬡
Duchess	32"	250	16 1/2"	19 1/2"	22 1/2"	●
Edwardian Style						
Mini Edwardian						○
8 1/2 x 8 1/2	18"	52	7 1/4"	9" x 9"	11" x 11"	○
Mini Edwardian						○
8 1/2 x 13	18"	58	7 1/4"	9" x 13"	11 1/4" x 15 3/4"	○
Edwardian	35"	125	8 1/4"	10 3/4" x 10 3/4"	13" x 13"	▲
Large Edwardian	36"	190	11 1/4"	14 1/4" x 14 1/4"	16 1/2" x 16 1/2"	☆
Magnum	46"	400	14 1/4"	18 1/4" x 18 1/4"	21 1/2" x 21 1/2"	⬡
Super Magnum	50"	540	18 1/4"	25" x 25"	27 1/2" x 27 1/2"	✘

Sizing Key



Circle indicates pots used to vent appliances with a maximum flue diameter of 8".
Shapes indicate the maximum opening width for single-face fireplaces.

STYLE	HEIGHT	WEIGHT	TOP OPENING	BASE I.D.	BASE O.D.
Empress	36"	308	19 1/4"	23 1/2"	27"
Essex	12"	60	12" x 12"	15" x 15"	17" x 17"
Excalibur	36"	130	(4) 7"	12 1/4" x 12 1/4"	14 1/4" x 14 1/4"
13x18 Excalibur	36"	195	(6) 7"	12 1/4" x 20"	14 1/4" x 22 1/4"
Fairmont	59"	290	9 1/2"	12 3/4" x 12 3/4"	15 3/4" x 15 3/4"
Governor	32"	116	4 1/2" x 8"	8" x 10 3/4"	10" x 13"
Large Governor	46"	480	12" x 16"	18" x 22 1/4"	20 3/4" x 25 1/2"
Halifax	30"	180	16 1/4"	20 1/4"	22 3/4"
Large Halifax	30"	457	20 1/2"	24" x 24"	27" x 27"
Hampshire	32"	165	12"	16"	18 1/2"
Mini Hampshire	18"	70	8 1/4"	10 1/4"	12 1/4"
Hanover	30"	250	14 1/4"	17 1/4" x 17 1/4"	20 1/2" x 20 1/2"
Imperial	82"	720	17 1/2"	22" x 22"	24" x 24"
Large Kensington	32"	122	10 1/4"	12" x 12"	14" x 14"
Small Kensington	30"	92	8 1/2"	7 3/4" x 11"	10" x 13 3/4"
Kent	33"	190	9 1/2" x 9 1/2"	14 1/2" x 14 1/2"	18" x 18"
King Arthur	33"	120	10"	12 1/4" x 12 1/4"	14 1/2" x 14 1/2"
Mandary	31"	63	(4) 2 1/4" x 5"	11 3/4"	13"
Small Mansard	13"	83	9" x 9"	13 1/4" x 13 1/4"	16" x 16"
Marquis	36"	450	24"	24"	29"
Mathis	26"	120	12 1/2"	16 1/2" x 16 1/2"	19" x 19"
Monarch	36"	280	18"	18"	20 3/4"
Nottingham	28"	186	20 1/4"	21 3/4"	24"
Peerless Style					
8 1/2 x 8 1/2 Peerless	26"	47	(4) 4 3/4" x 4 3/4"	7" x 7"	8 1/2" x 8 1/2"
8 1/2 x 13 Peerless	28"	69	(2) 5" x 8" (2) 5" x 5"	6 3/4" x 11 1/4"	8 1/2" x 13"
13x13 Peerless	30"	91	(4) 6" x 7"	11 1/2" x 11 1/2"	13" x 13"
13x18 Peerless	30"	168	(2) 6" x 9" (2) 6" x 6"	11 1/2" x 15 1/2"	13 1/2" x 17 3/4"
18x18 Peerless	30"	240	(4) 5 1/4" x 9 3/4"	15 3/4" x 15 3/4"	18" x 18"
Plaza	24"	110	12 1/4"	13 3/4" x 13 3/4"	16 1/4" x 16 1/4"
Large Plaza	32"	338	19 1/4"	22" x 22"	25" x 25"
Queen Anne	18"	56	8"	9 1/2"	12 1/2"
Savoy	24"	110	12 1/2"	14" x 14"	16 1/2" x 16 1/2"
Large Savoy	32"	338	19 1/4"	22" x 22"	25" x 25"
Sentry	25"	116	(4) 6 1/2" x 5"	15 1/2" x 15 1/2"	17 3/4" x 17 3/4"
Sherwood	28"	180	20 1/4"	21 3/4"	24"
Tuscan	31"	250	(4) 5" x 13" (4) 8" x 13"	15 1/4" x 20"	18 3/4" x 23 3/4"
Vanguard	30"	360	19" with (10) 4"	24"	27"
Victorian	25"	90	10 1/4" x 10 1/4"	13" x 13"	15" x 15"
Virginian	24"	85	10 1/2"	11 1/2"	14"
Wellington	26"	180	17 1/4"	22 1/2"	25 1/2"
Willow	34"	122	8 1/2"	12 1/4"	14 1/2"
Windsor	32"	142	12"	16 1/2"	19"
Mini Windsor	18"	65	8 1/4"	10 1/2"	12 3/4"
York	33"	202	14 3/4"	20" x 20"	22 1/2" x 22 1/2"



Custom Capabilities

Seven Standard and Custom Glazes Available

Want a Superior Clay chimney pot in a different color? Not a problem. Any of our pots can be ordered in any of seven standard glazes. In addition to natural terra cotta, choose from black, buff, blue limestone, gray limestone, sandstone, brick red or salt glaze (brown). And if none of these suit your fancy, we can develop custom glazes and finishes to meet your needs.

Buff

Black Glaze

Salt Glaze

Brick Red



Blue Limestone
(also available in Gray Limestone)

Sandstone



In addition to more than 60 standard chimney pots, Superior Clay also offers custom-made designs that add very personal character to a home. Whether you want to make minor modifications to an existing chimney pot or have us bring your own design to life, if it can be done,

our artisans can do it. Contact Superior Clay for quotations on custom work.

Custom Texture

Warwick 
33" Tall

Gargoyle 
23" Tall



Elizabethan 
18" Tall

Round

Top Opening from 7" to 24"

Rain Guards

Rain guards are available for just about any style of chimney pot. Round and Octagonal rain guards are used with chimney pots that have a round top opening and square rain guards are available for chimney pots and flues with a square top opening.



Octagonal
Top Opening from 7" to 18"

Square

Top Opening from 8" to 24"

1-800-848-6166
www.superiorclay.com



Smoke Chambers

Rumford - Large or Modified

SIZE	DIMENSIONS (D x W x H)	ASSEMBLY TYPE	DAMPER SIZE
8½ x 13	8½ x 23 x 19½	2 pc.	30" S.S.
13 x 13	13 x 34 x 30	2 pc.	30" Flat
12 x 16	12 x 34 x 30	2 pc.	24" Flat
13 x 18	13 x 34 x 30	2 pc.	30" Flat
16 x 20	16 x 34 x 30	2 pc.	30" Flat
18 x 18	18 x 32 x 30	4 pc.	30" Flat
20 x 20	20 x 50 x 30	4 pc.	42" Dome
20 x 24	20 x 57 x 32	6 pc.	48" Dome
24 x 24	24 x 66 x 36	12 pc.	60" Dome
24 x 24	24 x 57 x 32	6 pc.	48" Dome

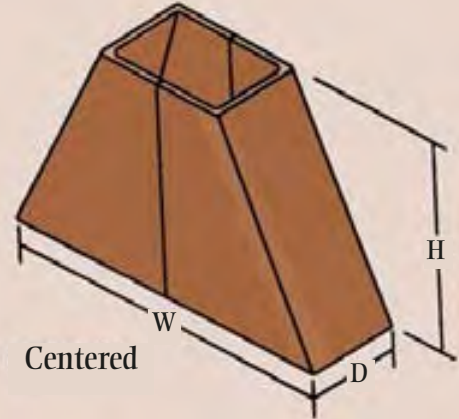

See-Thru

SIZE	DIMENSIONS (D x W x H)	ASSEMBLY TYPE	DAMPER SIZE
16 x 20	16 x 42 x 30	6 pc.	36" Dome
18 x 18	18 x 49 x 30	6 pc.	42" Dome
20 x 20	20 x 54 x 30	6 pc.	48" Dome
20 x 24	20 x 49 x 30	6 pc.	42" Dome
24 x 24	24 x 54 x 30	6 pc.	48" Dome
24 x 24	24 x 66 x 36	12 pc.	60" Dome
24 x 38	24 x 79 x 36	12 pc.	72" Dome

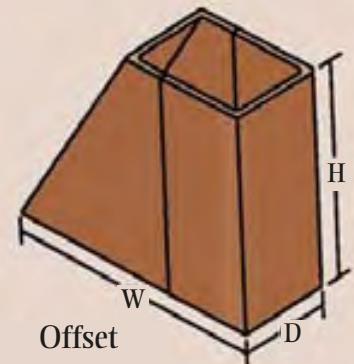

Short

SIZE	DIMENSIONS (D x W x H)	ASSEMBLY TYPE	DAMPER SIZE
8½ x 13	8½ x 24 x 19	2 pc.	30" S.S.
12 x 12	12 x 28 x 19½	2 pc.	24" Flat
13 x 13	13 x 30 x 18	2 pc.	24" Flat
12 x 16	12 x 27½ x 19	2 pc.	24" Flat
13 x 18	13 x 34 x 19	2 pc.	30" Flat
16 x 16	16 x 37 x 19	2 pc.	30" Flat
16 x 20	16 x 36 x 19	2 pc.	30" Flat

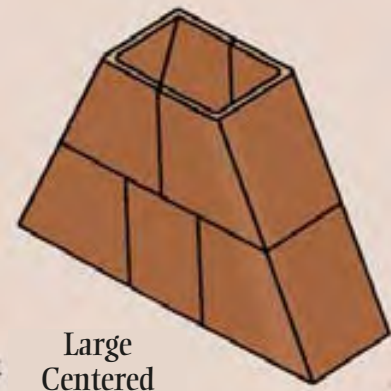

Other sizes available on request

Damper size listed is the maximum size damper to be used for that smoke chamber.
A smaller damper can be used if preferred.

Clay Flue Lining



Superior Clay manufactures a complete line of vitrified clay flue liners from 3" to 36" diameters in round flue liners and from 4" x 8" to 24" x 24" in square and rectangular flue liners. Socket type joints and self aligning joints are available in round flue liners. Superior manufactures flues with holes, contoured flue rings, and flue tees. Flue rings are available in lengths from 4" to 18".

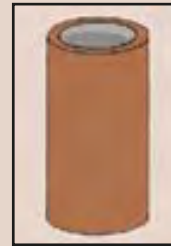

Standard Flue Ring

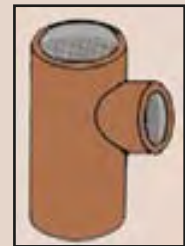

Round Flue Lining Tee



Contour Flue Ring

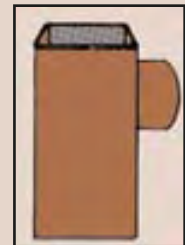

Square Flue Lining Tee

Superior Clay Flue Liner and Flue Ring Dimensions

Rectangular Flue Lining		Round Flue Lining		Flue Lining with Opening	
Outside Dimensions (Approx. In.)	Effective Flue Area (Sq. In.)	Normal Inside Diameter (In.)	Effective Flue Area (Sq. In.)	Flue Lining With Opening Size of Flue (In.)	Size of Opening (In.)
4 1/2 x 8 1/2	23	4	12	8 1/2 x 8 1/2	6 1/2
4 1/2 x 13	34	5	19	8 1/2 x 13	8 or 10
8 x 8	42	6	28	13 x 13	10
8 1/2 x 8 1/2	49	7	38	8 x 8	6 1/2
8 x 12	67	8	50	8x12	8 or 9
8 1/2 x 13	76	9	64	12 x 12	10
8 1/2 x 18	102	10	79		
12 x 12	102	12	113		
12 x 16	131	15	177		
13 x 13	127	18	255		
13 x 18	173	21	346		
16 x 16	181	24	452		
16 x 20	222	27	530		
18 x 18	233	30	706		
20 x 20	298	33	829		
20 x 24	335	36	989		
24 x 24	431				

Flue Ring Tees and Flue Tee Sizes correspond to those regular flue and flue rings.

Standard Flue Ring Sizes								
3 x 6	4 x 4	5 x 4	6 x 4	7 x 4	8 x 4	9 x 4	10 x 4	12 x 4
3 x 12	4 x 6	5 x 6	6 x 6	7 x 6	8 x 6	9 x 6	10 x 6	12 x 6
	4 x 9	5 x 9	6 x 9	7 x 9	8 x 9	9 x 9	10 x 9	12 x 9
	4 x 12	5 x 12	6 x 12	7 x 12	8 x 12	9 x 12	10 x 12	12 x 12
		5 x 15	6 x 15	7 x 15	8 x 15			
		5 x 18	6 x 18	7 x 18	8 x 18	9 x 18	10 x 18	12 x 18



Form, function, and *P*resentation.



Terra Cotta Wine Storage Tiles

Storing wine in Terra Cotta Tiles is the preferred method for serious collectors. Terra Cotta tiles, with their unique physical properties, have been used to safely store valuable collections for centuries. Terra Cotta tiles are right at home in the cool, humid environment of the wine cellar. They never rot or deteriorate. The thermal mass of the tiles help maintain ideal temperature and humidity by reducing fluctuations. And infinite flexibility combined with their natural beauty make them the perfect choice for collections of all sizes. Available in round, hexagonal or octagonal outer shapes as well as two or four bottle units, you can use Terra Cotta Wine Storage Tiles to display and store your favorite vintages.



Terra Cotta Wine Cellar Tiles

Round

These round tiles are available in 4 and 6 inch inside diameters, 12 inches long. Other sizes available on request.

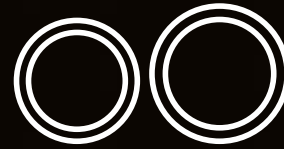

Octagonal

8-sided tiles.
4 inch inside diameter, 12 inches long.



Hexagonal

These 6-sided tiles interlock for easy stacking.
4 inch inside diameter, 12 inches long.



4 Bottle Set of Octagonal Tiles

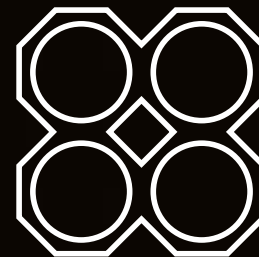

DESIGN/STYLE	INSIDE DIAMETER	OUTSIDE DIAMETER	WEIGHT
ROUND	4"	5 ¹ / ₈ "	6 lb
	6"	7"	14 lb
HEXAGON	4"	5 ¹ / ₈ "	8 lb
OCTAGON	HEIGHT	WIDTH	WEIGHT
OCTAGON	4"	5 ¹ / ₈ "	8 lb
4 UNIT CELL	10 ¹ / ₈ "	10 ¹ / ₈ "	28 lb



Fireplace Screens, Spark Guards

Rumford Collection

Boston Spark Guard Model PSG

Simple, inexpensive, functional, light weight and safe, Boston spark guards have an even longer tradition than Rumford fireplaces. The Model PSG features trim bands and brass handles. All screens made to order.

RS38 - 38" wide by 37" tall
RS44 - 44" wide by 43" tall
RS50 - 50" wide by 49" tall
RS62 - 62" wide by 55" tall
RS74 - 74" wide by 55" tall

Custom Sizes Available.



Boston Spark Guard Model PSG/1

The Model PSG/1 has broader bands and black handles. All screens made to order.

RS/1-38 - 38" wide by 37" tall
RS/1-44 - 44" wide by 43" tall
RS/1-50 - 50" wide by 49" tall
RS/1-62 - 62" wide by 55" tall
RS/1-74 - 74" wide by 55" tall

Custom Sizes Available.



FGN Series

Single Panel Screens, with a screen area about the same as the fireplace opening, are safe, simple and take up the least room. The model FGN is available in Matte Black or Vintage Iron (please specify). All screens made to order.

RSP38 - 38" wide by 37" tall
RSP44 - 44" wide by 43" tall
RSP50 - 50" wide by 49" tall

Custom Sizes Available.



FGN 19 Series

The Craftsman Screen, Model FGN19, comes with a trim hand-forged frame in Vintage Iron finish. All screens made to order.

RSCM38 - 38" wide by 37" tall
RSCM44 - 44" wide by 43" tall
RSCM50 - 50" wide by 49" tall

Custom Sizes Available.

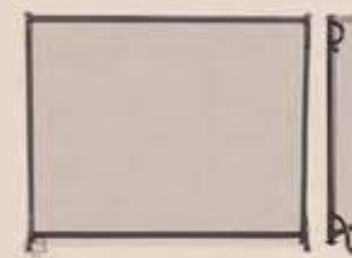

RSTP36

Tri-Panel Folding Screens in our Rumford Collection are taller than most at 36" tall. With a 36" central panel and 12" side panels, the screen will fit Rumford fireplaces from 36" wide up to 48" wide. All screens made to order.

Rectangular Center Panel.
Custom Sizes Available.



RSTPA36 - Arched center panel.

Custom Sizes Available.



Gas Logs For Rumford Fireplaces

by Rasmussen Iron Works, Inc.

Rumford gas log sets include: logs and burner, pan filler, embers and connector.

Andiron Classic and Retiring Tipi use Standard Rumford Burner. Rumford Tipi uses the Enhanced Rumford Burner.

Also available:

Propane Burner

Electronic Ignition Model EIS-N135

Safety Shutoff Model SPK3-TNA

Custom sizes and configurations.

Wireless Remote Control RPK1-F10-TNA



Rumford Tipi

RFT24 Rumford Tipi for 24" Rumford
RFT30 Rumford Tipi for 30" Rumford
RFT36 Rumford Tipi for 36" Rumford
RFT42 Rumford Tipi for 42" Rumford

RFT48 Rumford Tipi for 48" Rumford
RFT60 Rumford Tipi for 60" Rumford
RFT72 Rumford Tipi for 72" Rumford



Andiron Classic (andirons not included)

RFA24 Andiron Classic for 24" Rumford
RFA30 Andiron Classic for 30" Rumford
RFA36 Andiron Classic for 36" Rumford
RFA42 Andiron Classic for 42" Rumford

RFA48 Andiron Classic for 48" Rumford
RFA60 Andiron Classic for 60" Rumford
RFA72 Andiron Classic for 72" Rumford



Retiring Tipi

RFR24 Retiring Tipi for 24" Rumford
RFR30 Retiring Tipi for 30" Rumford
RFR36 Retiring Tipi for 36" Rumford
RFR42 Retiring Tipi for 42" Rumford

RFR48 Retiring Tipi for 48" Rumford
RFR60 Retiring Tipi for 60" Rumford
RFR72 Retiring Tipi for 72" Rumford

Terra Cotta... Unlimited Possibilities

The design freedom inherent in terra-cotta has been rediscovered by a new generation of architects. Terra-cotta offers full scale design and production capabilities with an unlimited range of colors and textures.

Terra-cotta is both in its structural and decorative form, unlimited in its ability to be formed to almost any shape, color or texture that the mind can conceive. Terra-cotta can be an economical alternative to stone and being a unique medium, many effects can be obtained that cannot be achieved with stone or other building materials.

Terra-cotta is unaffected by corrosives, it is fire proof, waterproof, strong, will not change form, it is colorfast and maintenance free. Many of the buildings built in the last century were masterpieces of terra-cotta design and construction. They stand as a testament to the artistic beauty, creativity of design and the flexibility and longevity of the material.



It's not *Just* a firebrick.



Keep your options open.

You work hard to select the right floor material. You agonize over wall coverings. You were torn between mauve and lilac. But you're going to leave the fireplace up to the mason?

Superior Clay offers a variety of standard and custom brick colors to create the perfect fireplace for your home. Available in our Rumford fireboxes or separately, you can combine these color options with a variety of coursing techniques to achieve virtually any look for your fireplace.



Firebrick

Decorative & Functional



The *Options* are endless with

Firebrick are bricks specially formulated and processed to withstand the repeated heating cycles in a fireplace. They must meet the requirements for ASTM C 1261.

Superior Clay offers 6 standard colors of firebrick, plus the ability to custom glaze firebrick in any color and finish, so we're able to provide the color that will best suit your home.

Black These bricks have an applied matte black glaze which produces a consistent solid finish.

Buff This yellow/white brick is the most common firebrick. Variations toward orange or gray are normal.

Gold Flecks of black, brown and buff work together to give this brick an overall earthy gold color.

Red This red firebrick has flecks of buff and variations from red to orange in color.

Ivory Similar to the Buff this brick is known for more consistent color and size. It is a bit rougher on the surface and contains flecks of black.



Running Bond



Herringbone

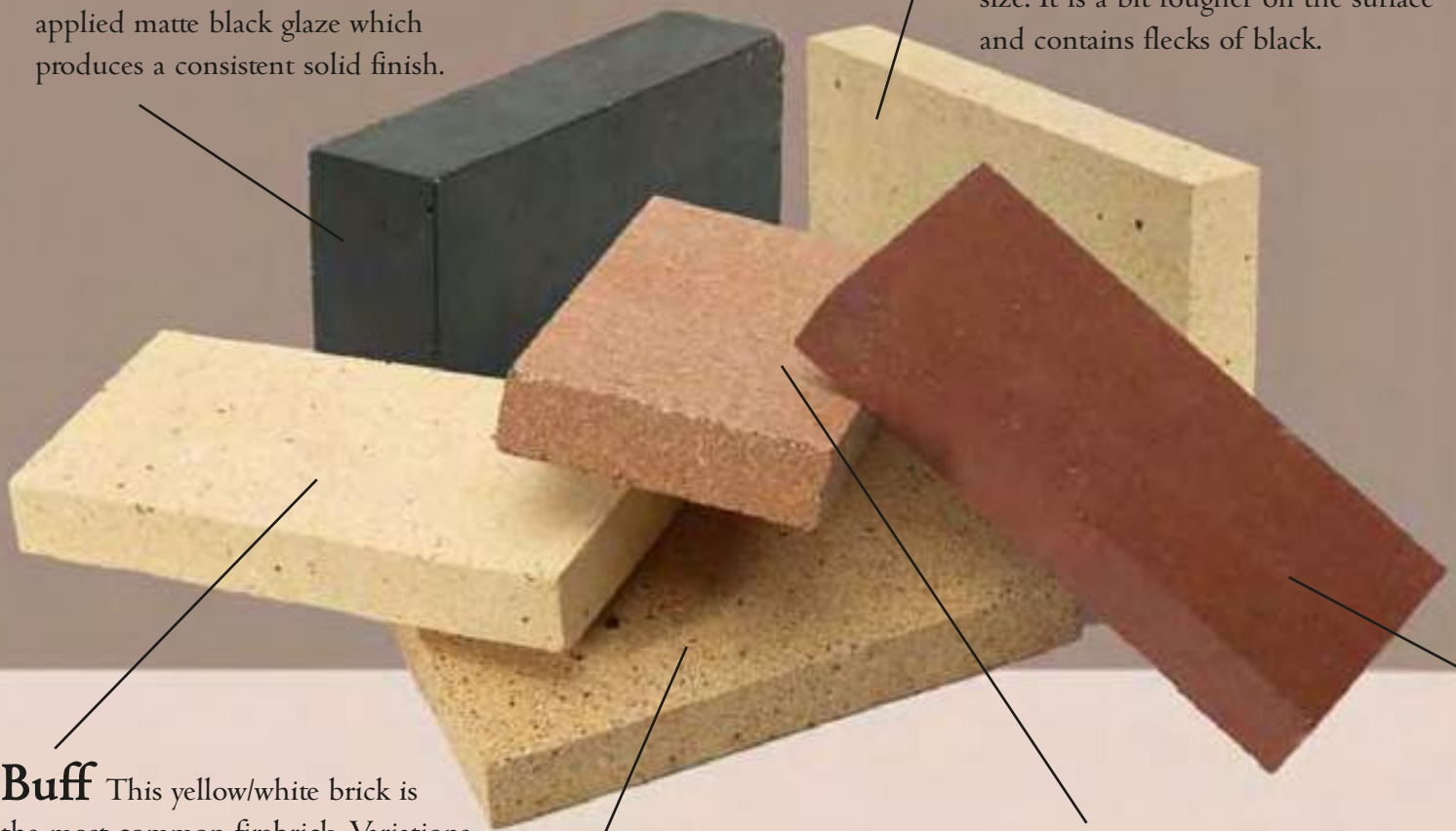

Superior Clay Firebrick

Buff	Size	Weight
9 X 4 1/2 X 2 1/2	FULL	7.3
9 X 4 1/2 X 1 1/4	SPLIT	4
9 X 4 X 2 1/4	SMALL	6
9 X 4 X 1 1/4	SMALL SPLIT	3.6
8 1/4 X 4 X 2 1/2	LADLE	6.3
8 1/4 X 4 X 1 1/4	LADLE SPLIT	3.5
9 X 4 1/2 X 2 1/2	OLD WORLD	7.3
Red		
9 X 4 1/2 X 2 1/2	FULL	7.3
9 X 4 1/2 X 1 1/4	SPLIT	4
9 X 4 1/2 X 2 1/2	OLD WORLD	7.3
Dark Red		
9 X 4 1/2 X 2 1/2	FULL	7.35
9 X 4 1/2 X 1 1/4	SPLIT	3.6
Ivory		
9 X 4 1/2 X 2 1/2	FULL	7.65
9 X 4 1/2 X 1 1/4	SPLIT	3.9
Gold		
9 X 4 1/2 X 2 1/2	FULL	8
9 X 4 1/2 X 1 1/4	SPLIT	4
Black		
9 X 4 1/2 X 2 1/2	FULL	7.3
Antique		
2 1/2 X 4 1/2 X 9		

Antique Firebrick

Superior Clay also offers antique firebrick – a selection of brick that have aged in our kilns for many years. These firebrick, by their very nature vary in color and texture, giving them an authentic antique appearance. Call for more details.



In addition to our standard and custom color options, Superior Clay firebrick can be professionally installed in a variety of patterns. Choosing coursing options such as "Running Bond" or "Herringbone" can help personalize and distinguish your firebox.

Firebrick

Decorative & Functional



Dark Red Deep red with a few flecks of buff, the overall appearance of this brick tends to be lightened when mortar washes into the cracks and crevices during installation.



Heat Stop Refractory Cement Products

Heat stop refractory cements should be used to install clay flue liners, firebrick and for masonry repairs. Heat Stop products provide resistance to temperatures of up to 2000° F. Meets all building codes.

FOR NEW CONSTRUCTION MARKET

Heat Stop

- Premixed & ready to use.
Color is gray.
- Ideal for firebrick construction of a fireplace firebox.
- Some insist on its premixed feature.
- Binder is sodium silicate. Easy clean-up.
- 15 lbs. - 1 gal. or 50 lbs. - 3 1/2 gal.
- Many uses for boilers, furnaces, kilns, etc.

Domestic Fireplace Mortar

- Same features as Heat Stop premixed only beige in color and looser consistency.
- 15 lbs. - 1 gal. or 50 lbs. - 3 1/2 gal.

Heat Stop II & Heat Stop 50

- Dry mix, just add water & mix.
- Its non-water soluble feature makes it the first choice for clay flue construction of a chimney.
- Binder is calcium aluminate. Meets N.F.P.A - 211.
- One product that meets all building codes.
- The pros use it for both firebrick and clay flue construction.
- Heat Stop II, 10 lbs., 1 gal.
- Heat Stop - 50 (50 lb. bag) is the most economical choice for both flues and firebrick. BEST BUY OF ALL.
- Also for sealing piping and wiring in wall, ceiling and floor penetrations.

All products meet ASTM C-199 & ASTM E-136. Heat Stop brand products have passed the test of time in hundreds of thousands of installations throughout all climates of North America.

FOR REPAIR MARKET

Flue Glue

- This product has all the features of Heat Stop II and Heat Stop 50 mix, however, it is far better for repair work. Stronger, more water and acid resistant.
- Ideal for do-it-yourself market.
- Great stuff for chimney sweeps and heating contractors.
- Repair broken firebrick, refill old mortar joints, repair broken or chipped clay flue lining. Repairs to boiler, ash pit, chimney crown, firebox, clay flues, vent connections, smoke chamber and more.
- 5 lbs. - 1/2 gal.



Heat Stop Products displayed with Rumford style fireplace.

Dampers

Superior Clay stocks these dampers. Other styles and sizes available on request.



FIREPLACE DAMPER - POKER CONTROL - ALL CAST IRON										
Model No.	Throat Dimensions			Height	Overall Dimensions			Standard Pkg.	Wt.Ea. Lbs.	Part Code
	Front	Back	Depth		Front	Back	Depth			
30	30"	23"	10"	6"	34"	26 ³ / ₄ "	13 ¹ / ₂ "	1	35	01-002
33	33"	26"	10"	6"	37"	29 ³ / ₄ "	13 ¹ / ₂ "	1	39	01-003
36	36"	29"	10"	6"	40"	32 ³ / ₄ "	13 ¹ / ₂ "	1	43	01-004
42	42"	35"	10"	6"	46"	38 ³ / ₄ "	13 ¹ / ₂ "	1	51	01-005
48	48"	41"	10"	6"	52"	44 ³ / ₄ "	13 ¹ / ₂ "	1	56	01-006

Note: When dome style dampers are used with Rumford throats or curved throat sections, a modified handle supplied by Superior Clay must be used.

Fireplace Cranes - Steel

Model	Size	Wt. (each)
015	22"	6.1
016	26 ¹ / ₂ "	7.0
017	33"	8.0
018	Grate hangers (pair)	1.0

Masonry Anchors Included with Above Cranes

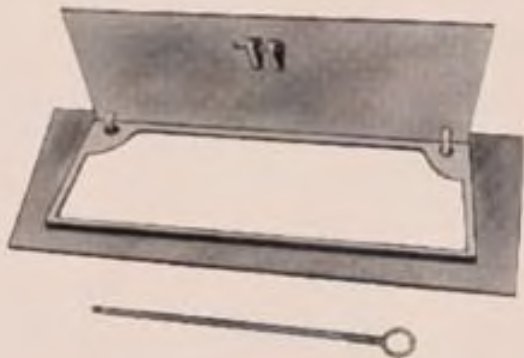

Flat Cast Iron Dampers

Flat cast iron dampers to fit the traditional straight-back Rumford fireplaces manufactured by Superior Clay Corp. with openings from 24" to 48" wide:

24" x 9" frame with 19" x 6" valve
 30" x 9" frame with 25" x 6" valve

A *Traditional* design for today's



Masonry ovens have been built in American homes since the first colonists landed here. Oven traditions date back much farther - to at least Roman times. Now you can have an authentic brick oven in your home or backyard.

Superior Clay makes components and provides plans and instructions for building these traditional masonry ovens. Bread and Pizza baking purists know that there is no substitute for these ovens made of bricks.



Cooking in a masonry oven requires some experimenting. A fire is built in the oven and stoked until the oven is heated sufficiently. When the oven is ready, throw some corn meal on the oven floor and bake right on the hot firebrick.

Some foods, such as pizzas, cook fast in a hot oven - three minutes at about 700 degrees F - and are cooked in the oven while the fire is still burning. French bread is traditionally baked in a periodic oven with a moist atmosphere and declining temperature. Heat the oven up to about 400 degrees F. Rake out the fire and mop the hearth with a wet towel. Load the oven with enough bread to fill the oven which will keep the

serious baker.

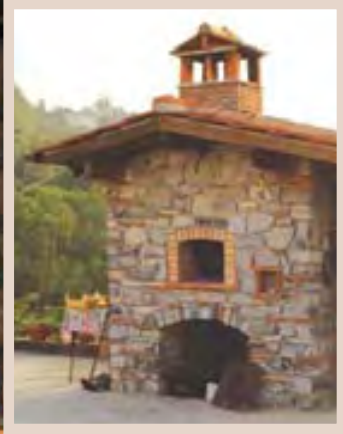

moisture high. Push the oven door all the way in past the flue entrance to seal in the moist heat until the bread is baked.

Meats and roasts can also be seared and roasted in a periodic oven with declining temperature after the fire has been raked out. The oven can be used as a smoker by keeping the temperature low, using the right wood and maybe a pan of liquid, depending on the recipe. And, of course, the oven is a great place to warm plates as it continues to cool. Enjoy!



Three Sizes To Choose From 18 inch 24 inch 36 inch

Wood fired masonry ovens, built of brick, stone and clay have been cooking and baking since the dawn of civilization. Superior Clay has developed components and a set of plans and instructions for the construction of these traditional ovens. Superior Clay wood fire ovens can be built along side a Rumford Fireplace or as a stand-alone unit in your kitchen or in your backyard. The exterior of the oven can be finished with a variety of masonry materials including brick, stone, stucco or tile.

Superior Clay offers a terra cotta shell, glazed or unglazed, to finish your oven. And an arched entrance or the entire shell is available in a variety of colors.

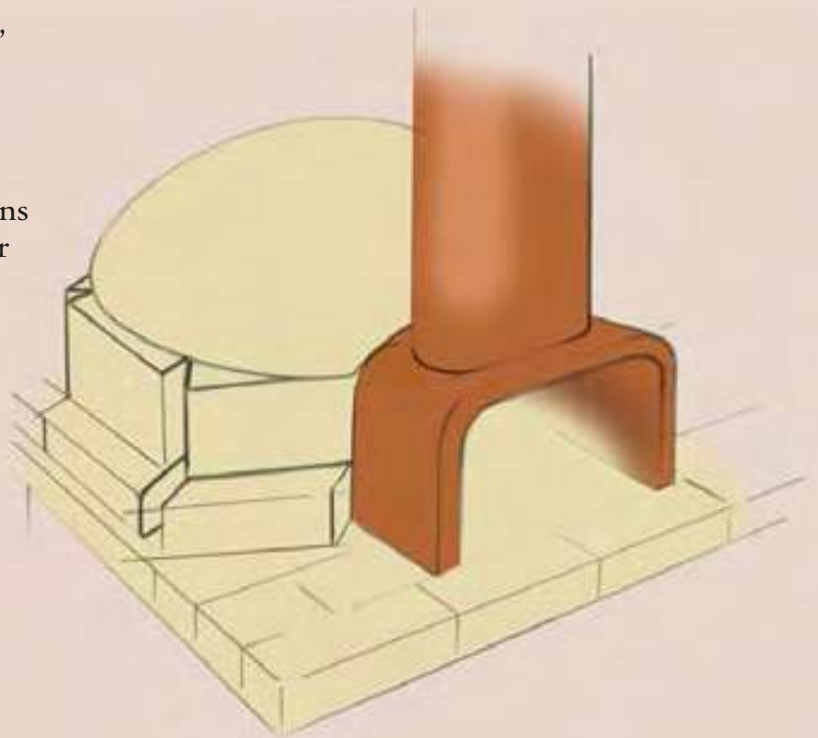

Materials List:

	18" Oven	24" Oven	36" Oven
Oven Dome	20" O.D.	27" O.D.	22" O.D.
Entrance Tunnel	10"	15"	18"
Heat Stop II Refractory Mortar	10 lb.	20 lb.	50 lb.
Insulating Castible	105 lb.	140 lb.	210 lb.
Firebricks needed for floor	40	50	40

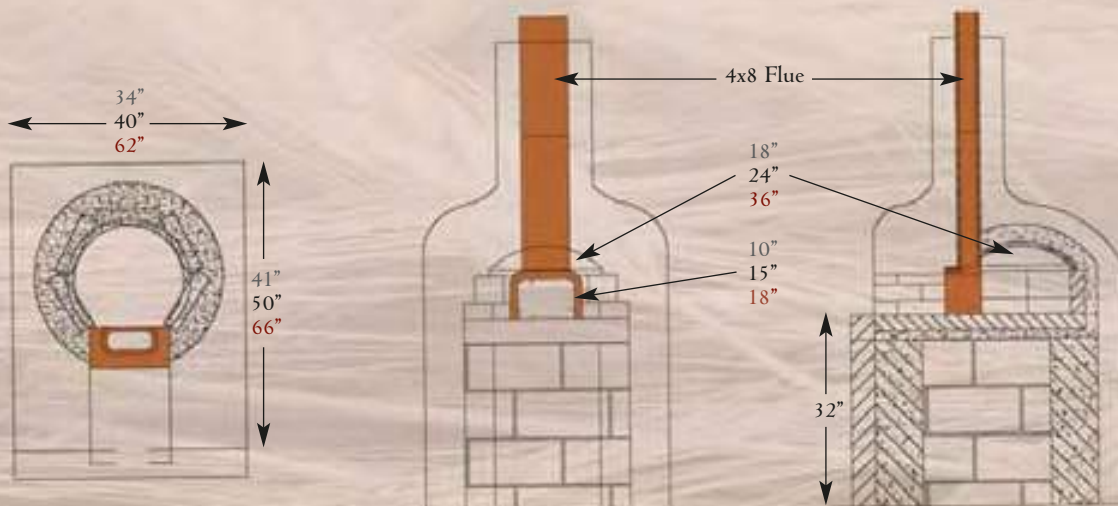

Terra Cotta Mailboxes



Hand crafted Terra Cotta Mailboxes, from Superior Clay, can add an element of sophistication to nearly any fine home. Featuring an elegant clamshell design, the Terra Cotta Mailbox includes a built-in, high-quality mailbox. Hand molded, then carefully dried and fired, the Terra Cotta Mailbox is sturdy and durable, as well as beautiful. It comes in four sections, ready to set on a foundation.

STYLE	BASE	HEIGHT	SHIPPING WEIGHT	MAILBOX
St. Augustine	21" W x 25" D	65"	775 lb	7 1/2" W x 9 1/2" H x 21" D

Clay Partition Block

Vitrified clay partition block are available in the following sizes with either smooth or grooved finish.

A	B	C
4"	12"	6"
4"	12"	12"
6"	12"	6"
6"	12"	12"
8"	12"	6"
8"	12"	12"

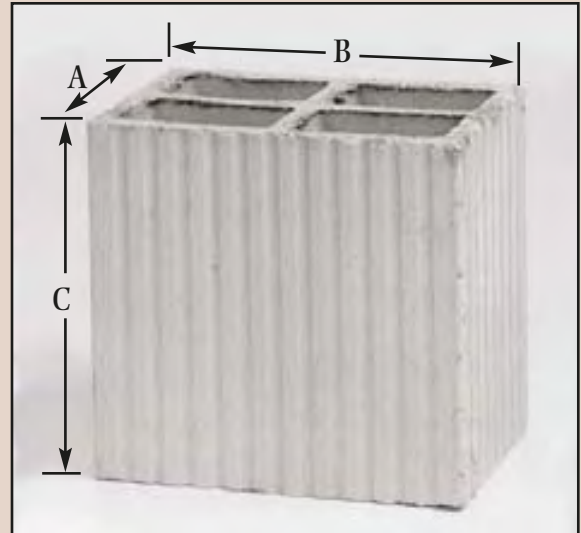

Wall Coping

Superior Clay Vitrified Clay Wall Coping protects the mortar and top masonry material as well as the inside wall by keeping water from penetrating the top and running down the inside structure. Particularly important to the architect or design engineer, the coefficient of thermal expansion for Superior Clay Wall Coping is the same as other clay masonry wall units and closer to concrete masonry wall units than other coping materials. With clean-line designs, Superior Clay Wall Coping is the choice for today's architecture.



Double Slant Wall Coping



Streamline Wall Coping



Single Slant Wall Coping



Camel Back Wall Coping

*A complete line of
Superior Clay fittings are available.*

Pipe and Fittings

Superior Clay manufactures a complete line of high quality sewer pipe and sump pipe.



Pipe with Holes

Combined with bar grates or strainers clay pipe with holes make economical sumps, floor and parking lot drains or catch basins that are the most durable available. Sizes are available from 6" diameter to 24" diameter.



Use Superior Clay Fireplace Components to Build Any Type of Fireplace

See Through • Large Fireplaces
Kiva Style • Arched Fireplaces
3 or 4 Sided • Corner Fireplaces

Superior Clay has taken the principles of Count Rumford and designed components that are used to build the best fireplaces available. Tests have shown Superior Clay Fireplaces:

- Deliver more heat to the room
- Wastes less heat up the chimney
- Burn more cleanly
- Provide greater resistance to downdrafts

Using Superior Clay components and following our designs masons can build fireplaces quickly and inexpensively. We do the engineering. Mantle and surround designs are unlimited using wood, brick, tile, stone or terra cotta. Call Superior Clay for plans, assistance during construction or the dealers nearest to you.

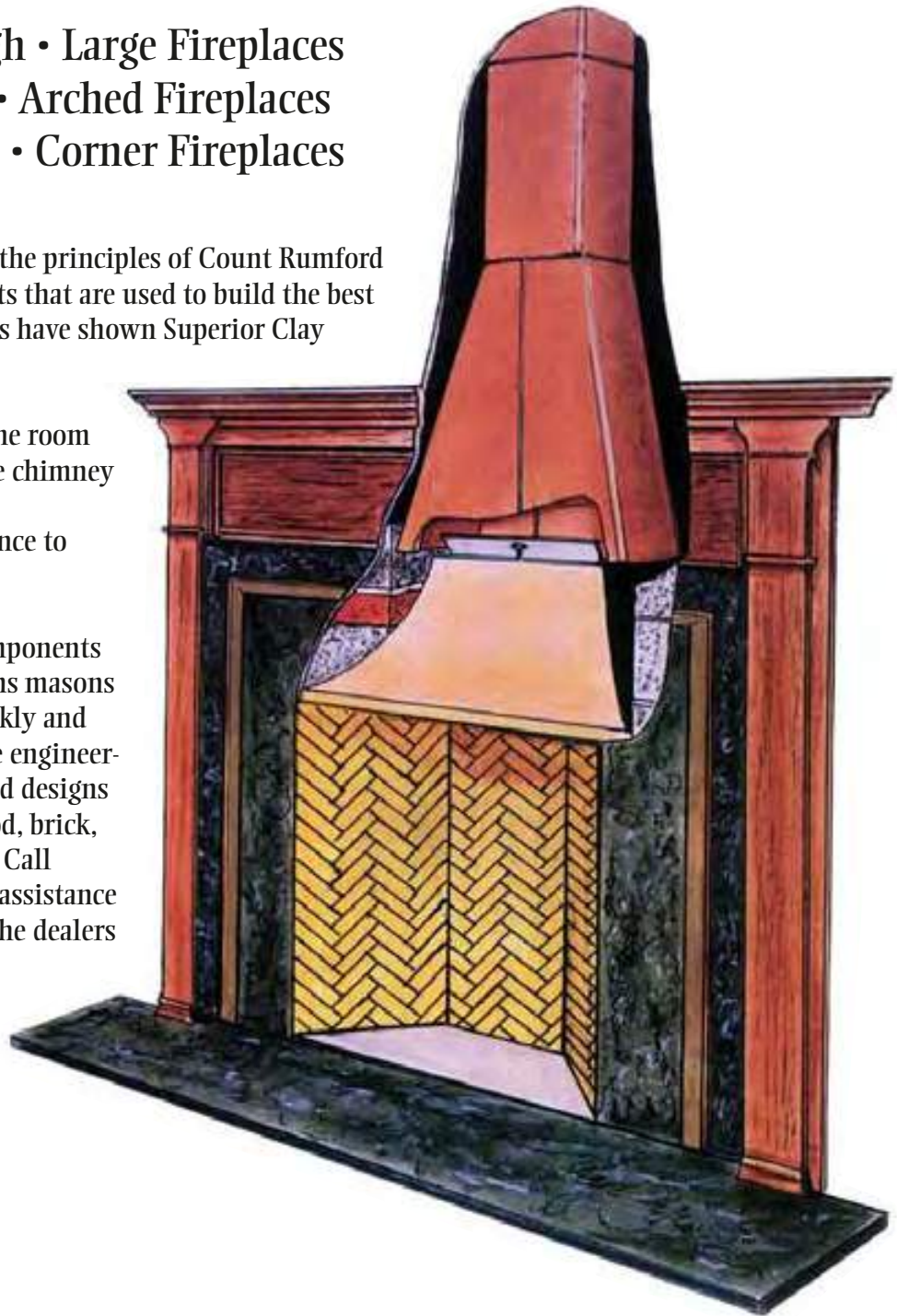

**Superior
Clay Corporation**

P.O. Box 352 • Uhrichsville, Ohio 44683 • (800) 848-6166
Visit our web site at <http://www.superiorclay.com>