



PRODUCT CATALOG

2019-2020





WORLD LEADING PRODUCT INNOVATION



Makita® Corporation was founded in 1915 as an electric motor sales and repair company. Today, as a global brand in over 40 countries, Makita® is an innovation leader, manufacturing best-in-class products at 10 plants operating in 8 countries. The unmatched quality and durability of Makita® products is driven by the company's strong R&D capabilities, and have earned the trust of professional users worldwide. Every day, on job sites around the world, Makita® delivers the power, performance and durability that professional users demand with products that are more compact, have less vibration and feel better.

Makita® Corporation of America is located in Buford, Georgia. As a part of our global network of ten manufacturing and assembly plants, Buford is one source of Makita® products used on job sites around the world. Our product development team works closely with engineers on job sites to develop products that exceed the demands of the American contractor. Buford, Georgia is also the site of the Makita® University, a hands-on educational experience where customers learn the latest technologies, products and applications.

PURPOSE-BUILT BRUSHLESS MOTORS



OUTER ROTOR

A direct-drive system that delivers the highest operating efficiency for more power, more speed and longer run time. The outer rotor brushless motor is inside select chain saws and string trimmers.

80mm, 52mm, 44mm & 38mm

Built for higher power and efficiency in a compact size with all-metal gear construction for extended durability. The 52mm brushless motor can be found in select blowers, trimmers, and more.



ONE SYSTEM WITH OVER 200 SOLUTIONS

USE THE SAME BATTERIES AND CHARGERS WITH ALL 36V AND 18V LXT® TOOLS

SUB-COMPACT

ULTRA-COMPACT
& LESS WEIGHT



Tools shown with optional accessories.

COMPACT

COMPACT DESIGN
& PERFORMANCE



PREMIUM

PREMIUM POWER
& RUN-TIME



GET 18V
WITH ONE LXT® BATTERY

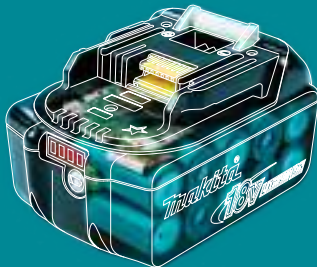

LXT® BATTERY

UP TO **50%** MORE RUN TIME¹

Battery delivers constant power and run time in extreme temperatures, even in winter (-4°F/ -20°C). Equipped with Star Protection Computer Controls™ to protect against overload, over-discharge, and overheating.

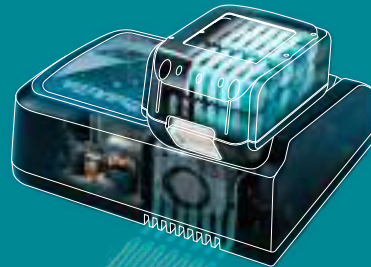

LXT® RAPID OPTIMUM CHARGER

UP TO **3X** FASTER CHARGING²

The Makita Rapid Optimum Charger communicates with the battery's built-in chip throughout the charging process to optimize battery life by actively controlling current, voltage and temperature.

¹ Vs. Makita® 18v Ni-Cd Battery

² Vs. Makita® 18v Ni-Cd Charger

BRUSHLESS
X2
 18V + 18V → 36V

MAXIMUM PERFORMANCE
 NO CORDS NEEDED



GET 36V
 WITH TWO LXT® BATTERIES

THE LXT® ADVANTAGE

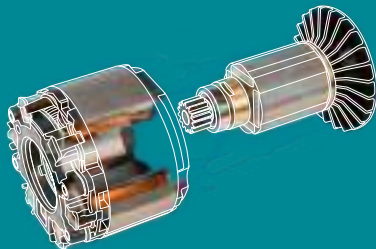

PURPOSE-BUILT BRUSHLESS MOTOR

UP TO **50% LONGER MOTOR LIFE**³

Makita-built Brushless Motor eliminates carbon brushes, enabling the motor to run cooler and more efficiently for longer life.

³ Vs. Makita® Cordless Motors with Brushes

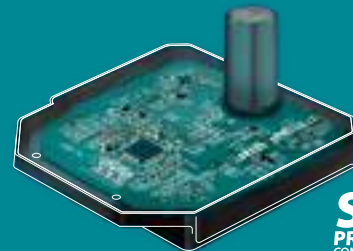

STAR PROTECTION
 COMPUTER CONTROLS™

STAR PROTECTION
 COMPUTER CONTROLS™

EFFICIENT POWER MANAGEMENT⁴

The demanding applications you take on every day are also demanding on your cordless tools and batteries. You rely on your tools, so Makita® created Star Protection Computer Controls™.

⁴ Protection against Overloading, Over-Discharging & Overheating



DISCOVER THE CONVENIENCE OF WIRELESS AUTO-START

CONNECT WITH BLUETOOTH®  Bluetooth®



 [LEARN MORE
MAKITATOOLS.COM/AWS](https://www.makitatools.com/aws)

WIRELESS DUST MANAGEMENT FOR MULTIPLE APPLICATIONS

AWS™ uses Bluetooth® technology for wireless power-on and power-off communication between the equipped tool and dust extractor. Once connected via AWS™, your dust extractor will automatically power on or off when your cordless tool starts or stops, running only when your cordless tool is in use.

ELIMINATES CORDS

Using our cordless LXT® dust extractor with a cordless LXT® tool means no more grounding issues, no re-plugging the cord, and reduced trip hazards.

INCREASES PRODUCTIVITY & CONVENIENCE

Intelligent Bluetooth® communication using dust extractor only while tool is in use extends battery run time of the dust extractor, increasing productivity on a single charge.

REDUCES EXCESSIVE NOISE

The AWS™ dust extractor / vacuum runs only while the AWS™ power tool is in use, reducing continuous noise at the job or work site.

ENABLES WIRELESS CONNECTION OF MAKITA AWS™ CAPABLE TOOLS

WITH COMPATIBLE DUST EXTRACTOR/VACUUM



198901-5

Auto-Start Wireless Transmitter

- Automatic-Start Wireless System (AWS™) utilizes Bluetooth® technology for wireless power-on/off communication between tool and dust extractor
- Provides intelligent communication between your tools to eliminate cords, increase productivity, and reduce noise
- Efficient design for convenient operation



LXT. BRUSHLESS **AVT**
XRH07PTU // PG. 30, 54 **AWS**

18V X2 LXT® (36V) Brushless 1-9/16" Advanced AVT® Rotary Hammer Kit, AWS™



LXT. BRUSHLESS **AVT**
XRH10Z // PG. 30, 55 **AWS CAPABLE**

18V X2 LXT® (36V) Brushless 1-1/8" AVT® Rotary Hammer, AFT®, AWS™ Capable



LXT. BRUSHLESS **AVT**
XRH11Z // PG. 30, 55 **AWS CAPABLE**

18V X2 LXT® (36V) Brushless 1-1/8" AVT® Rotary Hammer, AFT®, AWS™ Capable*



LXT. BRUSHLESS **AVT**
XRH12Z // PG. 31 **AWS CAPABLE**

18V LXT® Brushless 11/16" AVT® Rotary Hammer, AWS™ Capable*



LXT. BRUSHLESS
XAG23ZU1 // PG. 26, 79 **AWS**

18V X2 LXT® (36V) Brushless 9" Angle Grinder, AWS™*



LXT. BRUSHLESS
XAG22ZU1 // PG. 26, 79 **AWS**

18V X2 LXT® (36V) Brushless 7" Angle Grinder, AWS™*



LXT. BRUSHLESS
XAG21ZU // PG. 27, 76 **AWS**

18V LXT® Brushless 4-1/2" / 5" Paddle Switch Cut-Off/Angle Grinder, AWS™*



LXT. BRUSHLESS
XAG17ZU // PG. 27, 76 **AWS**

18V LXT® Brushless 4-1/2" / 5" Cut-Off/Angle Grinder, AWS™*



LXT. BRUSHLESS
XSH07PTU // PG. 22, 89 **AWS CAPABLE**

18V X2 LXT® (36V) Brushless 7-1/4" Circular Saw Kit, AWS™ Capable



LXT. BRUSHLESS
XSH05ZB // PG. 23, 89 **AWS CAPABLE**

18V LXT® Sub-Compact Brushless 6-1/2" Circular Saw, AWS™ Capable*



LXT. BRUSHLESS
XPS02PTU // PG. 24, 90 **AWS**

18V X2 LXT® (36V) Brushless 6-1/2" Plunge Circular Saw Kit, AWS™



LXT. BRUSHLESS
XSL04PTU // PG. 28, 94 **AWS**

18V X2 LXT® (36V) Brushless 10" Dual-Bevel Sliding Compound Miter Saw Kit, AWS™

* Tool only, battery & charger not included

LXT[®] SUB-COMPACT BRUSHLESS



MOST COMPACT, LIGHTEST WEIGHT, 18V COMPATIBILITY WITH BIG PERFORMANCE

Makita[®] created a new class in cordless with 18V LXT[®] Sub-Compact Brushless tools. Makita[®] Sub-Compact tools are the most compact and lightest weight in the 18V category, so users get 12V handling with 18V compatibility. Sub-Compact tools use the same 18V batteries and chargers that work with over 200 solutions in the LXT[®] system.



CX303TRB // PG. 12



CX300RB // PG. 12



CX301RB // PG. 12



CX200RB // PG. 13



CX201RB // PG. 13



XPH11RB // PG. 14



XFD11RB // PG. 15



XDT15R1B // PG. 17



XWT12RB // PG. 19



XSH05ZB // PG. 23



XSH04RB // PG. 23



XRJ07R1B // PG. 25



XRH06RB // PG. 31



XLC01ZB // PG. 36



XRM06B // PG. 38



XRM08B // PG. 38, 47





LXT



XT1501

18V LXT® 1/2" Hammer Driver-Drill (XPH10Z)	18V LXT® 1/2" Impact Wrench (XWT04Z)	18V LXT® 3/8" Angle Drill (XAD01Z)	18V LXT® Job Site Radio (XRM05)
18V LXT® Impact Driver (XDT11Z)	18V LXT® 1/2" Impact Wrench (XWT05Z)	18V LXT® L.E.D. Lantern/Flashlight (DML806)	18V LXT® 5-3/8" Metal Cutting Saw (XSC01Z)
18V LXT® Recipro Saw (XRJ04Z)	18V LXT® 7/8" Rotary Hammer (XRH04Z)	18V LXT® Xenon Flashlight (DML185)	(4) 18V LXT® Lithium-Ion 3.0Ah Battery (BL1830B)
18V LXT® 6-1/2" Circular Saw (XSS02Z)	18V LXT® Brushless 4,000 RPM Drywall Screwdriver (XSF03Z)	18V LXT® Blower (DUB182Z)	(2) 18V LXT® Lithium-Ion Rapid Optimum Charger (DC18RC)
18V LXT® Brushless 4-1/2" Cut-Off/Angle Grinder (XAG03Z)			

7-PIECE KITS



LXT BRUSHLESS

XT705PT

18V LXT® Brushless 1/2" Hammer Driver-Drill (XPH07Z)
18V LXT® Brushless 3-Speed Impact Driver (XDT14Z)
18V LXT® Brushless Recipro Saw (XRJ05Z)
18V LXT® Brushless 6-1/2" Circular Saw (XSH03Z)
18V LXT® Brushless 4-1/2" / 5" Cut-Off/Angle Grinder (XAG04Z)
18V LXT® / 12V max CX™ Bluetooth® Job Site Radio (XRM06B)
18V LXT® L.E.D. Flashlight (DML802)
(2) 18V LXT® Lithium-Ion 5.0Ah Battery (BL1850B)
18V LXT® Lithium-Ion Dual Port Charger (DC18RD)



LXT

XT706

18V LXT® 1/2" Hammer Driver-Drill (XPH10Z)
18V LXT® Impact Driver (XDT11Z)
18V LXT® 6-1/2" Circular Saw (XSS02Z)
18V LXT® Recipro Saw (XRJ04Z)
18V LXT® Brushless 4-1/2" / 5" Cut-Off/Angle Grinder (XAG04Z)
18V LXT® Blower (DUB182Z)
18V LXT® Xenon Flashlight (DML185)
(2) 18V LXT® Lithium-Ion 3.0Ah Battery (BL1830B)
18V LXT® Lithium-Ion Rapid Optimum Charger (DC18RC)



LXT

XT704

18V LXT® 1/2" Hammer Driver-Drill (XPH10Z)
18V LXT® Impact Driver (XDT11Z)
18V LXT® 6-1/2" Circular Saw (XSS02Z)
18V LXT® Recipro Saw (XRJ04Z)
18V LXT® Brushless 4-1/2" Cut-Off/Angle Grinder (XAG03Z)
18V LXT® Job Site Radio (XRM05)
18V LXT® L.E.D. Flashlight (DML802)
(2) 18V LXT® Lithium-Ion 3.0Ah Battery (BL1830B)
18V LXT® Lithium-Ion Rapid Optimum Charger (DC18RC)

6-PIECE KITS



LXT BRUSHLESS

XT611PT

- 18V LXT® Brushless 1/2" Hammer Driver-Drill (XPH07Z)
- 18V LXT® Brushless 3-Speed Impact Driver (XDT14Z)
- 18V LXT® Brushless Recipro Saw (XRJ05Z)
- 18V LXT® Brushless 6-1/2" Circular Saw (XSH03Z)
- 18V LXT® Brushless 4-1/2" / 5" Cut-Off/Angle Grinder (XAG04Z)
- 18V LXT® L.E.D. Flashlight (DML802)
- (2) 18V LXT® Lithium-Ion 5.0Ah Battery (BL1850B)
- 18V LXT® Lithium-Ion Dual Port Charger (DC18RD)



LXT BRUSHLESS

XT612M

- 18V LXT® Compact Brushless 1/2" Hammer Driver-Drill (XPH12Z)
- 18V LXT® Brushless Impact Driver (XDT13Z)
- 18V LXT® Brushless Recipro Saw (XRJ05Z)
- 18V LXT® Brushless 6-1/2" Circular Saw (XSH03Z)
- 18V LXT® Brushless 4-1/2" / 5" Cut-Off/Angle Grinder (XAG04Z)
- (2) 18V LXT® Lithium-Ion 4.0Ah Battery (BL1840B)
- 18V LXT® Xenon Flashlight (DML185)
- 18V LXT® Lithium-Ion Rapid Optimum Charger (DC18RC)



LXT

XT610

- 18V LXT® 1/2" Hammer Driver-Drill (XPH10Z)
- 18V LXT® Impact Driver (XDT11Z)
- 18V LXT® 6-1/2" Circular Saw (XSS02Z)
- 18V LXT® Recipro Saw (XRJ04Z)
- 18V LXT® Brushless 4-1/2" / 5" Cut-Off/Angle Grinder (XAG03Z)
- 18V LXT® Xenon Flashlight (DML185)
- (2) 18V LXT® Lithium-Ion 3.0Ah Battery (BL1830B)
- 18V LXT® Lithium-Ion Rapid Optimum Charger (DC18RC)



LXT

XT505

- 18V LXT® 1/2" Hammer Driver-Drill (XPH10Z)
- 18V LXT® Impact Driver (XDT11Z)
- 18V LXT® Recipro Saw (XRJ04Z)
- 18V LXT® 6-1/2" Circular Saw (XSS02Z)
- 18V LXT® Xenon Flashlight (DML185)
- (2) 18V LXT® Lithium-Ion 3.0Ah Battery (BL1830B)
- 18V LXT® Lithium-Ion Rapid Optimum Charger (DC18RC)

4-PIECE KITS



LXT BRUSHLESS

XT451T

- 18V LXT® Brushless 1/2" Hammer Driver-Drill (XPH07Z)
- 18V LXT® Brushless 3-Speed Impact Driver (XDT14Z)
- 18V LXT® Brushless 4-1/2" / 5" Cut-Off/Angle Grinder (XAG04Z)
- 18V LXT® L.E.D. Flashlight (DML802)
- (2) 18V LXT® Lithium-Ion 5.0Ah Battery (BL1850B)
- 18V LXT® Lithium-Ion Rapid Optimum Charger (DC18RC)



LXT BRUSHLESS

XT450T

- 18V LXT® Brushless 1/2" Hammer Driver-Drill (XPH07Z)
- 18V LXT® Brushless 3-Speed Impact Driver (XDT14Z)
- 18V LXT® Brushless Recipro Saw (XRJ05Z)
- 18V LXT® L.E.D. Flashlight (DML802)
- (2) 18V LXT® Lithium-Ion 5.0Ah Battery (BL1850B)
- 18V LXT® Lithium-Ion Rapid Optimum Charger (DC18RC)



LXT BRUSHLESS

XT449T

- 18V LXT® Brushless 1/2" Hammer Driver-Drill (XPH07Z)
- 18V LXT® Brushless 3-Speed Impact Driver (XDT14Z)
- 18V LXT® Brushless 6-1/2" Circular Saw (XSH03Z)
- 18V LXT® L.E.D. Flashlight (DML802)
- (2) 18V LXT® Lithium-Ion 5.0Ah Battery (BL1850B)
- 18V LXT® Lithium-Ion Rapid Optimum Charger (DC18RC)



LXT BRUSHLESS

XT448T

- 18V LXT® Brushless 1/2" Hammer Driver-Drill (XPH07Z)
- 18V LXT® Brushless Recipro Saw (XRJ05Z)
- 18V LXT® Brushless 6-1/2" Circular Saw (XSH03Z)
- 18V LXT® L.E.D. Flashlight (DML802)
- (2) 18V LXT® Lithium-Ion 5.0Ah Battery (BL1850B)
- 18V LXT® Lithium-Ion Rapid Optimum Charger (DC18RC)



LXT BRUSHLESS

XT447T

- 18V LXT® Compact Brushless 1/2" Hammer Driver-Drill (XPH12Z)
- 18V LXT® Brushless Impact Driver (XDT13Z)
- 18V LXT® Brushless Recipro Saw (XRJ05Z)
- 18V LXT® L.E.D. Flashlight (DML802)
- (2) 18V LXT® Lithium-Ion 5.0Ah Battery (BL1850B)
- 18V LXT® Lithium-Ion Rapid Optimum Charger (DC18RC)



LXT BRUSHLESS

XT446T

- 18V LXT® Compact Brushless 1/2" Hammer Driver-Drill (XPH12Z)
- 18V LXT® Brushless Impact Driver (XDT13Z)
- 18V LXT® Brushless 6-1/2" Circular Saw (XSH03Z)
- 18V LXT® L.E.D. Flashlight (DML802)
- (2) 18V LXT® Lithium-Ion 5.0Ah Battery (BL1850B)
- 18V LXT® Lithium-Ion Rapid Optimum Charger (DC18RC)



LXT

XT442

- 18V LXT® 1/2" Hammer Driver-Drill (XPH10Z)
- 18V LXT® Recipro Saw (XRJ04Z)
- 18V LXT® 6-1/2" Circular Saw (XSS02Z)
- 18V LXT® Xenon Flashlight (DML185)
- (2) 18V LXT® Lithium-Ion 3.0Ah Battery (BL1830B)
- 18V LXT® Lithium-Ion Rapid Optimum Charger (DC18RC)



LXT

XT440

- 18V LXT® 1/2" Hammer Driver-Drill (XPH10Z)
- 18V LXT® Impact Driver (XDT11Z)
- 18V LXT® Recipro Saw (XRJ04Z)
- 18V LXT® Xenon Flashlight (DML185)
- (2) 18V LXT® Lithium-Ion 3.0Ah Battery (BL1830B)
- 18V LXT® Lithium-Ion Rapid Optimum Charger (DC18RC)

3-PIECE KITS



5.0Ah BATTERY
2
1
1

LXT BRUSHLESS

NEW XT331PT

- 18V X2 (36V) LXT® Brushless Blower (XBU02Z)
- 18V X2 (36V) LXT® Brushless String Trimmer (XRU09Z)
- 18V X2 (36V) LXT® Brushless 14" Chain Saw (XCU03Z)
- (2) 18V LXT® Lithium-Ion 5.0Ah Battery (BL1850B)
- 18V LXT® Lithium-Ion Dual Port Charger (DC18RD)



5.0Ah BATTERY
2
1
1

LXT BRUSHLESS

XT330T

- 18V LXT® Brushless 1/2" Hammer Driver-Drill (XPH07Z)
- 18V LXT® Brushless 3-Speed Impact Driver (XDT14Z)
- 18V LXT® Brushless Recipro Saw (XRJ05Z)
- (2) 18V LXT® Lithium-Ion 5.0Ah Battery (BL1850B)
- 18V LXT® Lithium-Ion Rapid Optimum Charger (DC18RC)



5.0Ah BATTERY
2
1
1

LXT BRUSHLESS

NEW XT336T

- 18V LXT® Brushless 1/2" Hammer Driver-Drill (XPH07Z)
- 18V LXT® Brushless 3-Speed Impact Driver (XDT14Z)
- 18V LXT® Sub-Compact Brushless Recipro Saw (XRJ07Z)
- (2) 18V LXT® Lithium-Ion 5.0Ah Battery (BL1850B)
- 18V LXT® Lithium-Ion Rapid Optimum Charger (DC18RC)



5.0Ah BATTERY
2
1
1

LXT BRUSHLESS

NEW XT337T

- 18V LXT® Compact Brushless 1/2" Hammer Driver-Drill (XPH12Z)
- 18V LXT® Brushless Impact Driver (XDT13Z)
- 18V LXT® Sub-Compact Brushless Recipro Saw (XRJ07Z)
- (2) 18V LXT® Lithium-Ion 5.0Ah Battery (BL1850B)
- 18V LXT® Lithium-Ion Rapid Optimum Charger (DC18RC)



4.0Ah BATTERY
2
1
1

LXT BRUSHLESS

XT328M

- 18V LXT® Compact Brushless 1/2" Hammer Driver-Drill (XPH12Z)
- 18V LXT® Brushless Impact Driver (XDT13Z)
- 18V LXT® Brushless Recipro Saw (XRJ05Z)
- (2) 18V LXT® Lithium-Ion 4.0Ah Battery (BL1840B)
- 18V LXT® Lithium-Ion Rapid Optimum Charger (DC18RC)



2.0Ah BATTERY
2
1
1

LXT COMPACT

CT320R

- 18V LXT® 1/2" Driver-Drill (XFD01Z)
- 18V LXT® Brushless Impact Driver (XDT11Z)
- 18V LXT® Xenon Flashlight (DML185)
- (2) 18V LXT® Lithium-Ion Compact 2.0Ah Battery (BL1820B)
- 18V LXT® Lithium-Ion Rapid Optimum Charger (DC18RC)



5.0Ah BATTERY
2.0Ah BATTERY
2
1
1

LXT SUB-COMPACT BRUSHLESS

NEW CX303TRB

- 18V LXT® Sub-Compact Brushless 11/16" Rotary Hammer (XRH062B)
- 18V LXT® Sub-Compact Brushless Impact Driver (XDT152B)
- 18V LXT® Sub-Compact Brushless Recipro Saw (XRJ07ZB)
- 18V LXT® Lithium-Ion Compact 2.0Ah Battery (BL1820B)
- 18V LXT® Lithium-Ion 5.0Ah Battery (BL1850B)



2.0Ah BATTERY
2
1
1

LXT SUB-COMPACT BRUSHLESS

CX300RB

- 18V LXT® Sub-Compact Brushless 1/2" Driver-Drill (XFD11ZB)
- 18V LXT® Sub-Compact Brushless Impact Driver (XDT152B)
- 18V LXT® Sub-Compact Brushless Recipro Saw (XRJ07ZB)
- (2) 18V LXT® Lithium-Ion Compact 2.0Ah Battery (BL1820B)
- 18V LXT® Lithium-Ion Rapid Optimum Charger (DC18RC)

2-PIECE KITS



2.0Ah BATTERY
2
1

LXT SUB-COMPACT BRUSHLESS

CX301RB

- 18V LXT® Sub-Compact Brushless 1/2" Driver-Drill (XFD11ZB)
- 18V LXT® Sub-Compact Brushless Impact Driver (XDT152B)
- 18V LXT® / 12V max CX™ Bluetooth® Job Site Radio (XRM06B)
- (2) 18V LXT® Lithium-Ion Compact 2.0Ah Battery (BL1820B)
- 18V LXT® Lithium-Ion Rapid Optimum Charger (DC18RC)



5.0Ah BATTERY
2
1

LXT BRUSHLESS

NEW XT277PT

- 18V X2 (36V) LXT® Brushless Blower (XBU02Z)
- 18V X2 (36V) LXT® Brushless String Trimmer (XRU09Z)
- (2) 18V LXT® Lithium-Ion 5.0Ah Battery (BL1850B)
- 18V LXT® Lithium-Ion Dual Port Charger (DC18RD)



5.0Ah BATTERY
2
1

LXT BRUSHLESS

NEW XT276PT

- 18V X2 (36V) LXT® Brushless Blower (XBU02Z)
- 18V X2 (36V) LXT® Brushless 14" Chain Saw (XCU03Z)
- (2) 18V LXT® Lithium-Ion 5.0Ah Battery (BL1850B)
- 18V LXT® Lithium-Ion Dual Port Charger (DC18RD)



5.0Ah BATTERY
2
1
1

LXT COMPACT BRUSHLESS

XT275PT

- 18V LXT® Compact Brushless 1/2" Hammer Driver-Drill (XPH12Z)
- 18V LXT® Brushless 3-Speed Impact Driver (XDT14Z)
- (2) 18V LXT® Lithium-Ion 5.0Ah Battery (BL1850B)
- 18V LXT® Lithium-Ion Dual Port Charger (DC18RD)



4.0Ah BATTERY
2
1
1

LXT BRUSHLESS

XT269M

- 18V LXT® Compact Brushless 1/2" Hammer Driver-Drill (XPH12Z)
- 18V LXT® Brushless Impact Driver (XDT13Z)
- (2) 18V LXT® Lithium-Ion 4.0Ah Battery (BL1840B)
- 18V LXT® Lithium-Ion Rapid Optimum Charger (DC18RC)



2.0Ah BATTERY
2
1
1

LXT COMPACT BRUSHLESS

XT269R

- 18V LXT® Compact Brushless 1/2" Hammer Driver-Drill (XPH12Z)
- 18V LXT® Brushless Impact Driver (XDT13Z)
- (2) 18V LXT® Lithium-Ion Compact 2.0Ah Battery (BL1820B)
- 18V LXT® Lithium-Ion Rapid Optimum Charger (DC18RC)

2-PIECE KITS



LXT BRUSHLESS

XT268T

- 18V LXT® Brushless 1/2" Hammer Driver-Drill (XPH07Z)
- 18V LXT® Brushless 3-Speed Impact Driver (XDT14Z)
- (2) 18V LXT® Lithium-Ion 5.0Ah Battery (BL1850B)
- 18V LXT® Lithium-Ion Rapid Optimum Charger (DC18RC)



LXT BRUSHLESS

XT268M

- 18V LXT® Brushless 1/2" Hammer Driver-Drill (XPH07Z)
- 18V LXT® Brushless 3-Speed Impact Driver (XDT14Z)
- (2) 18V LXT® Lithium-Ion 4.0Ah Battery (BL1840B)
- 18V LXT® Lithium-Ion Rapid Optimum Charger (DC18RC)



LXT BRUSHLESS

XT267T

- 18V LXT® Brushless 1/2" Hammer Driver-Drill (XPH07Z)
- 18V LXT® Brushless Impact Driver (XDT13Z)
- (2) 18V LXT® Lithium-Ion 5.0Ah Battery (BL1850B)
- 18V LXT® Lithium-Ion Rapid Optimum Charger (DC18RC)



LXT X2 18V + 18V 36V

XT274PT

- 18V X2 (36V) LXT® Brushless Blower (XBU02Z)
- 18V X2 (36V) LXT® 12" Chain Saw (XCU02Z)
- (2) 18V LXT® Lithium-Ion 5.0Ah Battery (BL1850B)
- 18V LXT® Lithium-Ion Dual Port Charger (DC18RD)



LXT BRUSHLESS

XT267M

- 18V LXT® Brushless 1/2" Hammer Driver-Drill (XPH07Z)
- 18V LXT® Impact Driver (XDT13Z)
- (2) 18V LXT® Lithium-Ion 4.0Ah Battery (BL1840B)
- 18V LXT® Lithium-Ion Rapid Optimum Charger (DC18RC)



LXT

XT263M

- 18V LXT® 1/2" Hammer Driver Drill (XPH03Z)
- 18V LXT® Impact Driver (XDT11Z)
- (2) 18V LXT® Lithium-Ion 4.0Ah Battery (BL1840B)
- 18V LXT® Lithium-Ion Rapid Optimum Charger (DC18RC)



LXT

XT261M

- 18V LXT® 1/2" Hammer Driver-Drill (XPH10Z)
- 18V LXT® Impact Driver (XDT11Z)
- (2) 18V LXT® Lithium-Ion 4.0Ah Battery (BL1840B)
- 18V LXT® Lithium-Ion Rapid Optimum Charger (DC18RC)



LXT SUB-COMPACT BRUSHLESS

CX202RB

- 18V LXT® Sub-Compact Brushless 1/2" Hammer Driver-Drill (XPH112B)
- 18V LXT® Sub-Compact Brushless Impact Driver (XDT152B)
- (2) 18V LXT® Lithium-Ion Compact 2.0Ah Battery (BL1820B)
- 18V LXT® Lithium-Ion Rapid Optimum Charger (DC18RC)



LXT SUB-COMPACT BRUSHLESS

CX200RB

- 18V LXT® Sub-Compact Brushless 1/2" Driver-Drill (XFD112B)
- 18V LXT® Sub-Compact Brushless Impact Driver (XDT152B)
- (2) 18V LXT® Lithium-Ion Compact 2.0Ah Battery (BL1820B)
- 18V LXT® Lithium-Ion Rapid Optimum Charger (DC18RC)



LXT SUB-COMPACT BRUSHLESS

CX201RB

- 18V LXT® Sub-Compact Brushless 1/2" Driver-Drill (XFD112B)
- 18V LXT® Sub-Compact Brushless 3/8" Impact Wrench (XWT122B)
- (2) 18V LXT® Lithium-Ion Compact 2.0Ah Battery (BL1820B)
- 18V LXT® Lithium-Ion Rapid Optimum Charger (DC18RC)



LXT COMPACT

CT225R

- 18V LXT® Cordless 1/2" Driver-Drill (XFD10Z)
- 18V LXT® Impact Driver (XDT11Z)
- (2) 18V LXT® Lithium-Ion Compact 2.0Ah Battery (BL1820B)
- 18V LXT® Lithium-Ion Rapid Optimum Charger (DC18RC)



LXT BRUSHLESS

XT262T

- 18V LXT® Brushless 4,000 RPM Drywall Screwdriver (XSF03Z)
- 18V LXT® Impact Driver (XDT11Z)
- (2) 18V LXT® Lithium-Ion 5.0Ah Battery (BL1850B)
- 18V LXT® Lithium-Ion Rapid Optimum Charger (DC18RC)



LXT COMPACT

XT262R

- 18V LXT® Brushless 4,000 RPM Drywall Screwdriver (XSF03Z)
- 18V LXT® Impact Driver (XDT11Z)
- (2) 18V LXT® Lithium-Ion Compact 2.0Ah Battery (BL1820B)
- 18V LXT® Lithium-Ion Rapid Optimum Charger (DC18RC)



LXT

XT255T

- 18V LXT® Brushless 4,000 RPM Drywall Screwdriver (XSF03Z)
- 18V LXT® Cut-Out Tool (XOC01Z)
- (2) 18V LXT® Lithium-Ion 5.0Ah Battery (BL1850B)
- 18V LXT® Lithium-Ion Rapid Optimum Charger (DC18RC)



LXT COMPACT

XT255R

- 18V LXT® Brushless 4,000 RPM Drywall Screwdriver (XSF03Z)
- 18V LXT® Cut-Out Tool (XOC01Z)
- (2) 18V LXT® Lithium-Ion Compact 2.0Ah Battery (BL1820B)
- 18V LXT® Lithium-Ion Rapid Optimum Charger (DC18RC)



LXT

XT255TX2

- 18V LXT® Brushless 4,000 RPM Drywall Screwdriver (XSF03Z)
- 18V LXT® Cut-Out Tool (XOC01Z)
- (2) 18V LXT® Lithium-Ion 5.0Ah Battery (BL1850B)
- 18V LXT® Lithium-Ion Rapid Optimum Charger (DC18RC)
- Collated Autofeed Screwdriver Magazine (199145-0)



HIGH POWERED PERFORMANCE

POWER

BL™ Brushless Motor delivers 1,090 in.lbs. of Max Torque

ERGONOMICS

Compact and ergonomic design at only 8-1/8" long and weighs only 5.9 lbs. with battery

LXT BRUSHLESS

XPH07TB

18V LXT® Brushless 1/2" Hammer Driver-Drill Kit

- BL™ Brushless Motor delivers 1,090 in.lbs. of Max Torque
- 0-31,500 BPM for fast hammer drilling in masonry materials
- Efficient BL™ Brushless motor is electronically controlled to optimize battery energy use for up to 50% longer run time per charge
- The BL™ Brushless Motor eliminates carbon brushes, enabling the BL™ Motor to run cooler and more efficiently for longer life
- The electronically-controlled BL™ Brushless Motor efficiently uses energy to match torque and RPM to the changing demands of the application
- All metal variable 2-speed transmission (0-550 & 0-2,100 RPM) for a wide range of drilling, fastening and hammer drilling applications



5.0 BATTERY



XPH07Z

XPH07TB Includes: 18V LXT® Brushless 1/2" Hammer Driver-Drill (XPH07Z), (2) 18V LXT® Lithium-Ion 5.0Ah Battery (BL1850B), 18V LXT® Lithium-Ion Rapid Optimum Charger (DC18RC), Side Handle (126413-8), Depth Gauge (122576-8), Belt Clip (346317-0), Tool Case

XPH07Z Includes: Tool only, battery & charger not included Side Handle (126413-8), Depth Gauge (122576-8), Belt Clip (346449-3)

Capacity (steel)	1/2"
Capacity (wood)	3"
Capacity (masonry)	5/8"
No Load Speed (var. 2 spd)	0 - 550 / 0 - 2,100 RPM
Blows Per Minute (2 speed)	0 - 8,250 / 0 - 31,500 BPM
Maximum Torque (in.lbs./N•m)	1,090 in.lbs./125N•m
Battery	18V LXT® Lithium-Ion
Overall Length	8-1/8"
Net Weight (with battery)	5.9 lbs.
Shipping Weight	16.12 lbs.



4.0 BATTERY



LXT BRUSHLESS

XPH07MB

XPH07Z

18V LXT® Brushless 1/2" Hammer Driver-Drill Kit

- BL™ Brushless Motor delivers 1,090 in.lbs. of Max Torque
- 0-31,500 BPM for faster hammer drilling in masonry materials
- Efficient BL™ Brushless motor is electronically controlled to optimize battery energy use for up to 50% longer run time per charge
- All metal variable 2-speed transmission (0-550 & 0-2,100 RPM) for a wide range of drilling, fastening and hammer drilling applications

XPH07MB Includes: 18V LXT® Brushless 1/2" Hammer Driver-Drill (XPH07Z), (2) 18V LXT® Lithium-Ion 4.0Ah Battery (BL1840B), 18V LXT® Lithium-Ion Rapid Optimum Charger (DC18RC), Side Handle (126413-8), Depth Gauge (122576-8), Belt Clip (346317-0), Tool Case

XPH07Z Includes: Tool only, battery & charger not included Side Handle (126413-8), Depth Gauge (122576-8), Belt Clip (346449-3)

Capacity (steel)	1/2"
Capacity (wood)	3"
Capacity (masonry)	5/8"
No Load Speed (var. 2 spd)	0 - 550 / 0 - 2,100 RPM
Blows Per Minute (2 speed)	0 - 8,250 / 0 - 31,500 BPM
Maximum Torque (in.lbs./N•m)	1,090 in.lbs./125N•m
Battery	18V LXT® Lithium-Ion
Overall Length	8-1/8"
Net Weight (with battery)	5.9 lbs.
Shipping Weight	16.45 lbs.



4.0 BATTERY



LXT

XPH03MB

XPH03Z

18V LXT® 1/2" Hammer Driver-Drill Kit

- Mechanical 2-speed transmission (0-400 & 0-2,000 RPM) for a wide range of drilling, fastening and hammer drilling applications
- Compact and ergonomic design at only 8-7/8" long
- Weighs only 5.1 lbs. with battery for reduced operator fatigue
- All metal gears and aluminum gear housing for maximum job site durability
- Makita-built 4-pole motor delivers 750 in.lbs. of Max Torque

XPH03MB Includes: 18V LXT® 1/2" Hammer Driver Drill (XPH03Z), (2) 18V LXT® Lithium-Ion 4.0Ah Battery (BL1840B), 18V LXT® Lithium-Ion Rapid Optimum Charger (DC18RC), Side Handle (126131-8), Depth Gauge (122576-8), Belt Clip (346317-0), Bit Holder (452947-8), (2) Double Ended Bit, Tool Case

XPH03Z Includes: Tool only, battery & charger not included Side Handle (126131-8), Depth Gauge (122576-8), Belt Clip (346317-0)

Capacity (steel)	1/2"
Capacity (wood)	3"
Capacity (masonry)	5/8"
No Load Speed (var. 2 spd)	0 - 400 / 0 - 2,000 RPM
Blows Per Minute (2 speed)	0 - 6,000 / 0 - 30,000 BPM
Maximum Torque (in.lbs./N•m)	750 in.lbs./84N•m
Battery	18V LXT® Lithium-Ion
Overall Length	8-7/8"
Net Weight (with battery)	5.1 lbs.
Shipping Weight	12.79 lbs.



5.0 BATTERY



LXT COMPACT BRUSHLESS

XPH12T

XPH12Z

18V LXT® Compact Brushless 1/2" Hammer Driver-Drill Kit

- Variable 2-speed design (0-500 & 0-2,000 RPM) (0-7,500 & 0-30,000 BPM) covers a wide range of drilling, driving and hammer applications
- BL™ Brushless Motor delivers 530 in.lbs. of Max Torque
- Efficient BL™ Brushless motor is electronically controlled to optimize battery energy use for up to 50% longer run time per charge
- The BL™ Brushless Motor eliminates carbon brushes, enabling the BL™ Motor to run cooler and more efficiently for longer life
- The electronically-controlled BL™ Brushless Motor efficiently uses energy to match torque and RPM to the changing demands of the application

XPH12T Includes: 18V LXT® Compact Brushless 1/2" Hammer Driver-Drill (XPH12Z), (2) 18V LXT® Lithium-Ion 5.0Ah Battery (BL1850B), 18V LXT® Lithium-Ion Rapid Optimum Charger (DC18RC), Tool Case
XPH12Z Includes: Tool only, battery & charger not included

Capacity (steel)	1/2"
Capacity (wood)	1-1/2"
Capacity (masonry)	1/2"
No Load Speed (var. 2 spd)	0 - 500 / 0 - 2,000 RPM
Blows Per Minute (2 speed)	0 - 7,500 / 0 - 30,000 BPM
Maximum Torque (in.lbs./N•m)	530 in.lbs./60N•m
Battery	18V LXT® Lithium-Ion
Overall Length	7-1/8"
Net Weight (with battery)	4 lbs.
Shipping Weight	11.8 lbs.



2.0 BATTERY



LXT COMPACT BRUSHLESS

XPH12R

XPH12Z

18V LXT® Compact Brushless 1/2" Hammer Driver-Drill Kit

- Variable 2-speed design (0-500 & 0-2,000 RPM) (0-7,500 & 0-30,000 BPM) covers a wide range of drilling, driving and hammer applications
- BL™ Brushless Motor delivers 530 in.lbs. of Max Torque
- Efficient BL™ Brushless motor is electronically controlled to optimize battery energy use for up to 50% longer run time per charge
- The BL™ Brushless Motor eliminates carbon brushes, enabling the BL™ Motor to run cooler and more efficiently for longer life
- The electronically-controlled BL™ Brushless Motor efficiently uses energy to match torque and RPM to the changing demands of the application

XPH12R Includes: 18V LXT® Compact Brushless 1/2" Hammer Driver-Drill (XPH12Z), (2) 18V LXT® Lithium-Ion Compact 2.0Ah Battery (BL1820B), 18V LXT® Lithium-Ion Rapid Optimum Charger (DC18RC), Tool Case
XPH12Z Includes: Tool only, battery & charger not included

Capacity (steel)	1/2"
Capacity (wood)	1-1/2"
Capacity (masonry)	1/2"
No Load Speed (var. 2 spd)	0 - 500 / 0 - 2,000 RPM
Blows Per Minute (2 speed)	0 - 7,500 / 0 - 30,000 BPM
Maximum Torque (in.lbs./N•m)	530 in.lbs./60N•m
Battery	18V LXT® Compact Lithium-Ion
Overall Length	7-1/8"
Net Weight (with battery)	3.5 lbs.
Shipping Weight	10.7 lbs.



2.0 BATTERY



LXT SUB-COMPACT BRUSHLESS

XPH11RB

XPH11ZB

18V LXT® Sub-Compact Brushless 1/2" Hammer Driver-Drill Kit

- Compact and ergonomic design at only 6-15/16" long
- Weighs only 2.9 lbs. with battery for reduced operator fatigue
- Ideal for working in tight spaces
- Mechanical variable 2-speed transmission (0-500 & 0-1,700 RPM) (0-7,500 & 0-25,500 BPM) for a wide range of drilling and driving applications
- Dual L.E.D. lights illuminate the work area
- Ergonomically designed handle with rubberized soft grip provides increased comfort

XPH11RB Includes: 18V LXT® Sub-Compact Brushless 1/2" Hammer Driver-Drill (XPH11ZB), (2) 18V LXT® Lithium-Ion Compact 2.0Ah Battery (BL1820B), 18V LXT® Lithium-Ion Rapid Optimum Charger (DC18RC), Tool Case

XPH11ZB Includes: Tool only, battery & charger not included

Capacity (steel)	1/2"
Capacity (wood)	1-7/16"
Capacity (masonry)	1/2"
No Load Speed (var. 2 spd)	0 - 500 / 0 - 1,700 RPM
Blows Per Minute (2 speed)	0 - 7,500 / 0 - 25,500 BPM
Maximum Torque (in.lbs./N•m)	350 in.lbs./40N•m
Battery	18V LXT® Compact Lithium-Ion
Overall Length	6-15/16"
Net Weight (with battery)	2.9 lbs.
Shipping Weight	10.2 lbs.



2.0 BATTERY



LXT COMPACT

XPH10R

XPH10Z

18V LXT® Compact 1/2" Hammer Driver-Drill Kit

- Makita-built 4-pole motor delivers 480 in.lbs. of Max Torque
- Variable 2-speed design (0-600 & 0-1,900 RPM) covers a wide range of drilling, driving and hammer applications
- Compact and ergonomic design at only 7-3/4" long
- Weighs only 3.4 lbs. with battery for reduced operator fatigue
- Rubberized soft grip provides increased comfort on the job
- Dual L.E.D. lights with afterglow illuminate the work area

XPH10R Includes: 18V LXT® 1/2" Hammer Driver-Drill (XPH10Z), (2) 18V LXT® Lithium-Ion Compact 2.0Ah Battery (BL1820B), 18V LXT® Lithium-Ion Rapid Optimum Charger (DC18RC), Belt Clip, Tool Case

XPH10Z Includes: Tool only, battery & charger not included

Capacity (steel)	1/2"
Capacity (wood)	1-1/2"
Capacity (masonry)	1/2"
No Load Speed (var. 2 spd)	0 - 600 / 0 - 1,900 RPM
Blows Per Minute (2 speed)	0 - 9,000 / 0 - 28,500 BPM
Maximum Torque (in.lbs./N•m)	480 in.lbs./54N•m
Battery	18V LXT® Compact Lithium-Ion
Overall Length	7-3/4"
Net Weight (with battery)	3.4 lbs.
Shipping Weight	10.7 lbs.



LXT BRUSHLESS

XFD07T

XFD07Z

18V LXT® Brushless 1/2" Driver-Drill Kit

- BL™ Brushless Motor delivers 1,090 in.lbs. of Max Torque
- BL™ Brushless Motor eliminates carbon brushes, enabling the BL™ Motor to run cooler and more efficiently
- 3-stage L.E.D. gauge indicates battery charge level
- All metal variable 2-speed transmission (0 - 550 & 0 - 2,100 RPM) for a wide range of drilling and fastening applications
- Weighs only 5.8 lbs. with battery for reduced operator fatigue
- Compact and ergonomic design at only 8-1/8" long

XFD07T Includes: 18V LXT® Brushless 1/2" Driver-Drill (XFD07T), 18V LXT® Lithium-Ion Rapid Optimum Charger (DC18RC), (2) 18V LXT® Lithium-Ion 5.0Ah Battery (BL1850B), Side Handle (126413-8), Belt Clip (346317-0), Tool Case.

XFD07Z Includes: Tool only, battery & charger not included
Side Handle (126413-8), Belt Clip (346317-0), .

Capacity (steel)	1/2"
Capacity (wood)	3"
No Load Speed (var. 2 spd)	0 - 550 / 0 - 2,100 RPM
Maximum Torque (in.lbs./N•m)	1,090 in.lbs./125N•m
Battery	18V LXT® Lithium-Ion
Overall Length	8-1/8"
Net Weight (with battery)	5.8 lbs.
Shipping Weight	16.55 lbs.



LXT

XFD03M

XFD03Z

18V LXT® 1/2" Driver-Drill Kit

- Makita-built 4-pole motor delivers 750 in.lbs. of Max Torque, 25% more than the previous model LXFD01
- Mechanical 2-speed transmission (0-400 & 0-2,000 RPM) for a wide range of drilling and fastening applications
- Extreme Protection Technology (XPT™) engineered for improved dust and water resistance for operation in harsh job site conditions
- All metal gears and aluminum gear housing for maximum job site durability
- Shift-Lock™ Drive System quickly shifts between modes
- Dual L.E.D. lights with afterglow enhanced illumination of work area

XFD03M Includes: 18V LXT® 1/2" Driver-Drill (XFD03Z), (2) 18V LXT® Lithium-Ion 4.0Ah Battery (BL1840B), 18V LXT® Lithium-Ion Rapid Optimum Charger (DC18RC), Side Handle (419216-0), Bit Holder (452947-8), Belt Clip (346034-7), Tool Case

XFD03Z Includes: Tool only, battery & charger not included
Side Handle (419216-0), Belt Clip (346034-7)

Capacity (steel)	1/2"
Capacity (wood)	3"
No Load Speed (var. 2 spd)	0 - 400 / 0 - 2,000 RPM
Maximum Torque (in.lbs./N•m)	750 in.lbs./84N•m
Battery	18V LXT® Lithium-Ion
Overall Length	8-7/8"
Net Weight (with battery)	5 lbs.
Shipping Weight	16 lbs.



LXT COMPACT BRUSHLESS

XFD12T

XFD12Z

18V LXT® Compact Brushless 1/2" Driver-Drill Kit

- Mechanical 2-speed transmission (0-500 & 0-2,000 RPM) for a wide range of drilling and fastening applications
- BL™ Brushless motor delivers 530 in.lbs. of Max Torque
- Efficient BL™ Brushless Motor is electronically controlled to optimize battery energy use for up to 50% longer run time per charge
- The BL™ Brushless Motor eliminates carbon brushes, enabling the BL™ Motor to run cooler and more efficiently for longer life
- The electronically-controlled BL™ Brushless Motor efficiently uses energy to match torque and RPM to the changing demands of the application

XFD12T Includes: 18V LXT® Compact Brushless 1/2" Driver-Drill (XFD12Z), (2) 18V LXT® Lithium-Ion 5.0Ah Battery (BL1850B), 18V LXT® Lithium-Ion Rapid Optimum Charger (DC18RC), Tool Case

XFD12Z Includes: Tool only, battery & charger not included

Capacity (steel)	1/2"
Capacity (wood)	1-1/2"
No Load Speed (var. 2 spd)	0 - 500 / 0 - 2,000 RPM
Maximum Torque (in.lbs./N•m)	530 in.lbs./60N•m
Battery	18V LXT® Lithium-Ion
Overall Length	6-3/4"
Net Weight (with battery)	3.9 lbs.
Shipping Weight	11.6 lbs.



LXT COMPACT BRUSHLESS

XFD12R

XFD12Z

18V LXT® Compact Brushless 1/2" Driver-Drill Kit

- Mechanical 2-speed transmission (0-500 & 0-2,000 RPM) for a wide range of drilling and fastening applications
- BL™ Brushless motor delivers 530 in.lbs. of Max Torque
- Efficient BL™ Brushless Motor is electronically controlled to optimize battery energy use for up to 50% longer run time per charge
- The BL™ Brushless Motor eliminates carbon brushes, enabling the BL™ Motor to run cooler and more efficiently for longer life
- The electronically-controlled BL™ Brushless Motor efficiently uses energy to match torque and RPM to the changing demands of the application

XFD12R Includes: 18V LXT® Compact Brushless 1/2" Driver-Drill (XFD12Z), (2) 18V LXT® Lithium-Ion Compact 2.0Ah Battery (BL1820B), 18V LXT® Lithium-Ion Rapid Optimum Charger (DC18RC), Tool Case

XFD12Z Includes: Tool only, battery & charger not included

Capacity (steel)	1/2"
Capacity (wood)	1-1/2"
No Load Speed (var. 2 spd)	0 - 500 / 0 - 2,000 RPM
Maximum Torque (in.lbs./N•m)	530 in.lbs./60N•m
Battery	18V LXT® Compact Lithium-Ion
Overall Length	6-3/4"
Net Weight (with battery)	3.4 lbs.
Shipping Weight	10.6 lbs.



Includes one battery

LXT BRUSHLESS

XFD131

18V LXT® Brushless 1/2" Driver-Drill Kit

- Mechanical 2-speed transmission (0-500 & 0-1,900 RPM) for a wide range of drilling and fastening applications
- BL™ Brushless motor delivers 440 in.lbs. of Max Torque
- Efficient BL™ Brushless Motor is electronically controlled to optimize battery energy use for up to 50% longer run time per charge
- The BL™ Brushless Motor eliminates carbon brushes, enabling the BL™ Motor to run cooler and more efficiently for longer life
- The electronically-controlled BL™ Brushless Motor efficiently uses energy to match torque and RPM to the changing demands of the application

XFD131 Includes: 18V LXT® Lithium-Ion 3.0Ah Battery (BL1830B), 18V LXT® Lithium-Ion Charger (DC18SD), Tool Bag

Capacity (steel)	1/2"
Capacity (wood)	1-1/2"
No Load Speed (var. 2 spd)	0 - 500 / 0 - 1,900 RPM
Maximum Torque (in.lbs./N•m)	440 in.lbs./50N•m
Battery	18V LXT® Lithium-Ion
Overall Length	6-5/8"
Net Weight (with battery)	3.8 lbs.
Shipping Weight	7.25 lbs.



LXT SUB-COMPACT BRUSHLESS

XFD11RB

XFD11ZB

18V LXT® Sub-Compact Brushless 1/2" Driver-Drill Kit

- Compact and ergonomic design at only 6-3/8" long
- Weighs only 2.8 lbs. with battery for reduced operator fatigue
- Ideal for working in tight spaces
- Mechanical variable 2-speed transmission (0-500 & 0-1,700 RPM) for a wide range of drilling and driving applications
- Dual L.E.D. lights illuminate the work area
- Ergonomically designed handle with rubberized soft grip provides increased comfort

XFD11RB Includes: 18V LXT® Sub-Compact Brushless 1/2" Driver-Drill (XFD11ZB), (2) 18V LXT® Lithium-Ion Compact 2.0Ah Battery (BL1820B), 18V LXT® Lithium-Ion Rapid Optimum Charger (DC18RC), Tool Case

XFD11ZB Includes: Tool only, battery & charger not included

Capacity (steel)	1/2"
Capacity (wood)	1-7/16"
No Load Speed (var. 2 spd)	0 - 500 / 0 - 1,700 RPM
Maximum Torque (in.lbs./N•m)	350 in.lbs./40N•m
Battery	18V LXT® Compact Lithium-Ion
Overall Length	6-3/8"
Net Weight (with battery)	2.8 lbs.
Shipping Weight	10.6 lbs.



LXT SUB-COMPACT BRUSHLESS

XFD11R1B

XFD11ZB

18V LXT® Sub-Compact Brushless 1/2" Driver-Drill Kit

- Compact and ergonomic design at only 6-3/8" long
- Weighs only 2.8 lbs. with battery for reduced operator fatigue
- Ideal for working in tight spaces
- Mechanical variable 2-speed transmission (0-500 & 0-1,700 RPM) for a wide range of drilling and driving applications
- Dual L.E.D. lights illuminate the work area
- Ergonomically designed handle with rubberized soft grip provides increased comfort

XFD11R1B Includes: 18V LXT® Sub-Compact Brushless 1/2" Driver-Drill (XFD11ZB), 18V LXT® Lithium-Ion Compact 2.0Ah Battery (BL1820B), 18V LXT® Lithium-Ion Rapid Optimum Charger (DC18RC), 14" Contractor Tool Bag (831253-8)

XFD11ZB Includes: Tool only, battery & charger not included

Capacity (steel)	1/2"
Capacity (wood)	1-7/16"
No Load Speed (var. 2 spd)	0 - 500 / 0 - 1,700 RPM
Maximum Torque (in.lbs./N•m)	350 in.lbs./40N•m
Battery	18V LXT® Compact Lithium-Ion
Overall Length	6-3/8"
Net Weight (with battery)	2.8 lbs.
Shipping Weight	9.45 lbs.



LXT COMPACT

XFD10R

XFD10Z

18V LXT® Compact 1/2" Driver-Drill Kit

- Makita-built 4-pole motor delivers 480 in.lbs. of Max Torque
- Mechanical 2-speed transmission (0-600 & 0-1,900 RPM) for a wide range of drilling and driving applications
- Features Extreme Protection Technology (XPT™) which is engineered to provide increased dust and water resistance in harsh job site conditions
- Dual L.E.D. lights with afterglow illuminate the work area
- Ergonomically designed handle with rubberized soft grip provides increased comfort
- All metal gear construction for increased durability

XFD10R Includes: 18V LXT® Cordless 1/2" Driver-Drill (XFD10Z), (2) 18V LXT® Lithium-Ion Compact 2.0Ah Battery (BL1820B), 18V LXT® Lithium-Ion Rapid Optimum Charger (DC18RC), Tool Case

XFD10Z Includes: Tool only, battery & charger not included

Capacity (steel)	1/2"
Capacity (wood)	1-1/2"
No Load Speed (var. 2 spd)	0 - 600 / 0 - 1,900 RPM
Maximum Torque (in.lbs./N•m)	480 in.lbs./54N•m
Battery	18V LXT® Compact Lithium-Ion
Overall Length	7-1/4"
Net Weight (with battery)	3.3 lbs.
Shipping Weight	10.6 lbs.



SUPERIOR SPEED, MAX EFFICIENCY

PERFORMANCE

Drills up to 160 2-9/16" holes per charge in 2x SPF*

SPEED

Delivers no-load drilling speeds of 0-350 RPM and 0-1,400 RPM for maximum efficiency



LXT BRUSHLESS

NEW XAD03PT

18V X2 LXT® (36V) Brushless 1/2" Right Angle Drill Kit

- Drills up to 160 2-9/16" holes per charge in 2x SPF* ("with two 5.0Ah batteries and self feed bit, self feed bit sold separately)
- Automatic Speed Change™ technology adjusts drill speed and torque during drilling for optimum performance
- Extreme Protection Technology (XPT™) is engineered for improved dust and water resistance for operation in harsh conditions
- Metal-gear housing increases tool durability and extends reliability
- Variable 2-speed design (0-350 RPM and 0-1,400 RPM) for optimum speed control and drilling versatility
- Torque limiter; built-in clutch reduces gear damage by disengaging gears if the bit binds (low speed only)
- Electric brake for maximum productivity
- Built-in L.E.D. light illuminates the work area
- Adjustable top handle for easy positioning

XAD03PT Includes: 18V X2 LXT® (36V) Brushless 1/2" Right Angle Drill (XAD03Z), (2) 18V LXT® Lithium-Ion 5.0Ah Battery (BL1850B), 18V LXT® Lithium-Ion Dual Port Charger (DC18RD), Tool Bag (831271-6), Side Handle (126802-7), Wrench (763204-6), Drill Chuck (763250-5), Chuck Key (763251-3)

XAD03Z Includes: Tool only, battery & charger not included. Side Handle (126802-7), Wrench (763204-6), Drill Chuck (763250-5), Chuck Key (763251-3)

Capacity (wood, w/ hole saw)	6-1/4"
Capacity (wood, w/ ship auger bit)	2"
Capacity (wood, w/ self feed bit)	4-5/8"
No Load Speed (var. 2 spd)	0 - 350 / 1 - 1,400 RPM
Battery	2X 18V LXT® Lithium-Ion
Overall Length	21-1/4"
Net Weight (with battery)	14 lbs.
Chuck Size	1/2"
Chuck Type	Keyed
Shipping Weight	29 lbs.



LXT

XAD02

XAD02Z

18V LXT® 3/8" Angle Drill Kit

- Makita-built 4-pole motor delivers 121 in.lbs. of Max Torque
- Variable speed (0-1,800 RPM) for a wide range of drilling and driving applications
- 3/8" keyless chuck for fast and easy bit installation and removal
- Compact 3-1/2" angle head height for use in close quarters
- Compact and ergonomic design at only 12-3/8" long
- Weighs only 4.0 lbs. with battery for reduced operator fatigue

XAD02 Includes: 18V LXT® 3/8" Angle Drill (XAD02Z), (2) 18V LXT® Lithium-Ion 3.0Ah Battery (BL1830B), 18V LXT® Lithium-Ion Rapid Optimum Charger (DC18RC), Tool Bag

XAD02Z Includes: Tool only, battery & charger not included

Capacity (steel)	3/8"
Capacity (wood)	1"
No Load Speed (variable speed)	0 - 1,800 RPM
Maximum Torque (in.lbs./N·m)	121 in.lbs./14N·m
Battery	18V LXT® Lithium-Ion
Overall Length	12-3/8"
Net Weight (with battery)	4 lbs.
Shipping Weight	13.45 lbs.



LXT

XAD01

XAD01Z

18V LXT® 3/8" Angle Drill Kit

- Makita-built 4-pole motor delivers 121 in.lbs. of Max Torque
- Variable speed (0-1,800 RPM) for a wide range of drilling and driving applications
- 3/8" keyed metal chuck for improved bit gripping power
- Compact 2-5/8" angle head height for use in close quarters
- Compact and ergonomic design at only 12-3/8" long
- Weighs only 4.0 lbs. with battery for reduced operator fatigue

XAD01 Includes: 18V LXT® 3/8" Angle Drill (XAD01Z), (2) 18V LXT® Lithium-Ion 3.0Ah Battery (BL1830), 18V LXT® Lithium-Ion Rapid Optimum Charger (DC18RC), Chuck Key Holder (450688-0), Chuck Key (763415-9), Tool Bag

XAD01Z Includes: Tool only, battery & charger not included. Chuck Key Holder (450688-0), Chuck Key (763415-9)

Capacity (steel)	3/8"
Capacity (wood)	1"
No Load Speed (variable speed)	0 - 1,800 RPM
Maximum Torque (in.lbs./N·m)	121 in.lbs./14N·m
Battery	18V LXT® Lithium-Ion
Overall Length	12-3/8"
Net Weight (with battery)	4 lbs.
Shipping Weight	13.45 lbs.



IMPACTS

HIGH SPEED IN A COMPACT SIZE

INNOVATION

Assist Mode and two Tightening Mode features help eliminate "screw cam-out" and "cross threading"

PRECISION

Reverse rotation auto-stop mode stops rotation and impact when fastener is loosened adequately



LXT BRUSHLESS

NEW XDT16T

18V LXT® Brushless 4-Speed Impact Driver Kit

- Quick-Shift Mode™ uses the brushless motor's electronic controls to find the best balance of speed and torque for each application
- BL™ Brushless Motor delivers 3,600 Max RPM and 1,600 in.lbs. of Max Torque
- 4-speed power selection (0-1,100 / 0-2,100 / 0-3,200 / 0-3,600 RPM & 0-1,100 / 0-2,600 / 0-3,600 / 0-3,800 IPM) provides precise fastening control
- Assist Mode (A-mode) feature helps eliminate "screw cam-out" and "cross threading" by driving at low speed until tightening begins
- Two Tightening Modes (T-mode) for faster tightening of self-drilling screws in thick or thin gauge metal; helps prevent damage to the screw
- Reverse rotation auto-stop mode stops rotation and impact when fastener is loosened adequately
- Built-in L.E.D. lights on both sides helps eliminate shadows and illuminate a larger area
- Compact and ergonomic design at only 4-9/16" long

XDT16T Includes: 18V LXT® Brushless 4-Speed Impact Driver (XDT16Z), (2) 18V LXT® Lithium-Ion 5.0Ah Battery (BL1850B), 18V LXT® Lithium-Ion Rapid Optimum Charger (DC18RC)

XDT16Z Includes: Tool only, battery & charger not included

Hex Shank	1/4"
Speed power selection	4
No Load Speed (var. 4 spd.)	0 - 1,100 / 0 - 2,100 / 0 - 3,200 / 0 - 3,600 RPM
Impacts Per Minute (var. 4 spd.)	0 - 1,100 / 0 - 2,600 / 0 - 3,600 / 0 - 3,800 IPM
Maximum Torque (in.lbs.)	1,600 in.lbs.
Overall Length	4-9/16"
Net Weight (with battery)	3.4 lbs.



LXT BRUSHLESS

NEW XDT16R

18V LXT® Compact Brushless 4-Speed Impact Driver Kit

- Quick-Shift Mode™ uses the brushless motor's electronic controls to find the best balance of speed and torque for each application
- BL™ Brushless Motor delivers 3,600 Max RPM and 1,600 in.lbs. of Max Torque
- 4-speed power selection (0-1,100 / 0-2,100 / 0-3,200 / 0-3,600 RPM & 0-1,100 / 0-2,600 / 0-3,600 / 0-3,800 IPM) provides precise fastening control
- Assist Mode (A-mode) feature helps eliminate "screw cam-out" and "cross threading" by driving at low speed until tightening begins

XDT16R Includes: 18V LXT® Brushless 4-Speed Impact Driver (XDT16Z), (2) 18V LXT® Lithium-Ion Compact 2.0Ah Battery (BL1820B), 18V LXT® Lithium-Ion Rapid Optimum Charger (DC18RC), Tool Case

XDT16Z Includes: Tool only, battery & charger not included

Hex Shank	1/4"
Speed power selection	4
No Load Speed (var. 4 spd.)	- 1,100 / - 2,100 / - 3,200 / - 3,600 RPM
Impacts Per Minute (var. 4 spd.)	- 1,100 / - 2,600 / - 3,600 / - 3,800 IPM
Maximum Torque (in.lbs.)	1,600 in.lbs.
Overall Length	4-9/16"
Net Weight (with battery)	2.7 lbs.



LXT BRUSHLESS

XDT14T

XDT14Z

18V LXT® Brushless 3-Speed Impact Driver Kit

- Quick-Shift Mode™ uses the brushless motor's electronic controls to find the best balance of speed and torque for each application
- Tightening Mode (T-mode) for faster tightening of self-drilling screws; helps prevent damage to the screw or workpiece
- 3-speed power selection switch (0-1,100 / 0-2,100 / 0-3,600 RPM & 0-1,100 / 0-2,600 / 0-3,800 IPM) provides precise fastening control
- BL™ Brushless Motor delivers 3,600 Max RPM and 1,550 in.lbs. of Max Torque

XDT14T Includes: 18V LXT® Brushless 3-Speed Impact Driver (XDT14Z), (2) 18V LXT® Lithium-Ion 5.0Ah Battery (BL1850B), 18V LXT® Lithium-Ion Rapid Optimum Charger (DC18RC), Tool Case (824774-7)

XDT14Z Includes: Tool only, battery & charger not included

Hex Shank	1/4"
No Load Speed (var. 3 spd.)	0 - 1,100 / 0 - 2,100 / 0 - 3,600 RPM
Impacts Per Minute (var. 3 spd.)	0 - 1,100 / 0 - 2,600 / 0 - 3,800 IPM
Maximum Torque (in.lbs./N·m)	1,550 in.lbs./175N·m
Battery	18V LXT® Lithium-Ion
Overall Length	4-5/8"
Net Weight (with battery)	3.3 lbs.
Shipping Weight	12.5 lbs.





LXT BRUSHLESS

XDT13T

XDT13Z

18V LXT® Brushless Impact Driver Kit

- BL™ Brushless Motor delivers 1,500 in.lbs. of Max Torque
- Variable speed (0-3,400 RPM & 0-3,600 IPM) for a wide range of fastening applications
- The BL™ Brushless Motor eliminates carbon brushes, enabling the BL™ Motor to run cooler and more efficiently for longer life
- Efficient BL™ Brushless Motor is electronically controlled to optimize battery energy use for up to 50% longer run time per charge
- The electronically-controlled BL™ Brushless Motor efficiently uses energy to match torque and RPM to the changing demands of the application
- Compact and ergonomic design at only 5" long

XDT13T Includes: 18V LXT® Brushless Impact Driver (XDT13Z), (2) 18V LXT® Lithium-Ion 5.0Ah Battery (BL1850B), 18V LXT® Lithium-Ion Rapid Optimum Charger (DC18RC), Tool Case (141856-3)

XDT13Z Includes: Tool only, battery & charger not included

Hex Shank	1/4"
No Load Speed (variable speed)	0 - 3,400 RPM
Impacts Per Minute (variable speed)	0 - 3,600 IPM
Maximum Torque (in.lbs./N•m)	1,500 in.lbs./170N•m
Battery	18V LXT® Lithium-Ion
Overall Length	5"
Net Weight (with battery)	3.3 lbs.
Shipping Weight	11.7 lbs.



LXT BRUSHLESS

XDT131

XDT13Z

18V LXT® Brushless Impact Driver Kit

- BL™ Brushless Motor delivers 1,500 in.lbs. of Max Torque
- Variable speed (0-3,400 RPM & 0-3,600 IPM) for a wide range of fastening applications
- The BL™ Brushless Motor eliminates carbon brushes, enabling the BL™ Motor to run cooler and more efficiently for longer life
- Efficient BL™ Brushless Motor is electronically controlled to optimize battery energy use for up to 50% longer run time per charge
- The electronically-controlled BL™ Brushless Motor efficiently uses energy to match torque and RPM to the changing demands of the application
- Compact and ergonomic design at only 5" long

XDT131 Includes: 18V LXT® Brushless Impact Driver (XDT13Z), 18V LXT® Lithium-Ion 3.0Ah Battery (BL1830B), 18V LXT® Lithium-Ion Charger (DC18SD), Tool Bag

XDT13Z Includes: Tool only, battery & charger not included

Hex Shank	1/4"
No Load Speed (variable speed)	0 - 3,400 RPM
Impacts Per Minute (variable speed)	0 - 3,600 IPM
Maximum Torque (in.lbs./N•m)	1,500 in.lbs./170N•m
Battery	18V LXT® Lithium-Ion
Overall Length	5"
Net Weight (with battery)	3.3 lbs.
Shipping Weight	7.1 lbs.



LXT COMPACT BRUSHLESS

XDT13R

XDT13Z

18V LXT® Compact Brushless Impact Driver Kit

- BL™ Brushless Motor delivers 1,500 in.lbs. of Max Torque
- Variable speed (0-3,400 RPM & 0-3,600 IPM) for a wide range of fastening applications
- The BL™ Brushless Motor eliminates carbon brushes, enabling the BL™ Motor to run cooler and more efficiently for longer life
- Efficient BL™ Brushless Motor is electronically controlled to optimize battery energy use for up to 50% longer run time per charge
- The electronically-controlled BL™ Brushless Motor efficiently uses energy to match torque and RPM to the changing demands of the application

XDT13R Includes: 18V LXT® Brushless Impact Driver (XDT13Z), (2) 18V LXT® Lithium-Ion Compact 2.0Ah Battery (BL1820B), 18V LXT® Lithium-Ion Rapid Optimum Charger (DC18RC), Tool Case (141856-3)

XDT13Z Includes: Tool only, battery & charger not included

Hex Shank	1/4"
No Load Speed (variable speed)	0 - 3,400 RPM
Impacts Per Minute (variable speed)	0 - 3,600 IPM
Maximum Torque (in.lbs./N•m)	1,500 in.lbs./170N•m
Battery	18V LXT® Compact Lithium-Ion
Overall Length	5"
Net Weight (with battery)	2.8 lbs.
Shipping Weight	10.7 lbs.



LXT COMPACT BRUSHLESS

XDT15R1B

XDT15ZB

18V LXT® Sub-Compact Brushless Impact Driver Kit

- Compact and ergonomic design at only 5-5/16"
- Weighs only 2.6 lbs. with battery for reduced operator fatigue
- Ideal for working in tight spaces
- BL™ Brushless Motor delivers 1,240 in.lbs. of Max Torque in an ultra compact design
- Variable 2-speed (0-1,300/0-3,000 RPM & 0-1,600/0-3,900 IPM) for a wide range of fastening applications
- Assist Mode (A-mode) feature helps eliminate "screw cam-out" and "cross threading" by driving at low speed until tightening begins

XDT15R1B Includes: 18V LXT® Sub-Compact Brushless Impact Driver (XDT15ZB), 18V LXT® Lithium-Ion Compact 2.0Ah Battery (BL1820B), 18V LXT® Lithium-Ion Rapid Optimum Charger (DC18RC), 14" Contractor Tool Bag (831253-8)

XDT15ZB Includes: Tool only, battery & charger not included

Hex Shank	1/4"
No Load Speed (var. 2 spd)	0 - 1,300 / 0 - 3,000 RPM
Impacts Per Minute (var. 2 spd.)	0 - 1,600 / 0 - 3,900 IPM
Maximum Torque (in.lbs./N•m)	1,240 in.lbs./140N•m
Battery	18V LXT® Compact Lithium-Ion
Overall Length	5-5/16"
Net Weight (with battery)	2.6 lbs.
Shipping Weight	9.2 lbs.



LXT COMPACT

XDT11R

18V LXT® Compact Impact Driver Kit

- Variable speed (0-2,900 RPM & 0-3,500 IPM) and 1,460 in.lbs. of torque for a wide range of fastening applications
- All metal gear housing for increased job site durability
- Compact and ergonomic design at only 5-3/8" long
- Weighs only 2.8 lbs. with battery for reduced operator fatigue
- Convenient one-touch 1/4" hex chuck for quick bit changes
- Features Extreme Protection Technology (XPT™) which is engineered to provide increased dust and water resistance in harsh job site conditions

XDT11R Includes: 18V LXT® Impact Driver (XDT11Z), (2) 18V LXT® Lithium-Ion Compact 2.0Ah Battery (BL1820B), 18V LXT® Lithium-Ion Rapid Optimum Charger (DC18RC), Tool Case

Hex Shank	1/4"
No Load Speed (variable speed)	0 - 2,900 RPM
Impacts Per Minute (variable speed)	0 - 3,500 IPM
Maximum Torque (in.lbs./N•m)	1,460 in.lbs./165N•m
Battery	18V LXT® Compact Lithium-Ion
Overall Length	5-3/8"
Net Weight (with battery)	2.8 lbs.
Shipping Weight	10.3 lbs.



LXT BRUSHLESS OIL-IMPULSE

XST01Z

18V LXT® Brushless Oil-Impulse 3-Speed Impact Driver

- Oil-Impulse™ Technology utilizes oil to hydraulically drive the impact mechanism for lower noise and increased efficiency
- Quick-Shift Mode™ selector has an automatic electronic controller that downshifts and reduces rotation and impact speed prior to driving screw
- The BL™ Brushless Motor eliminates carbon brushes, enabling the BL™ Motor to run cooler and more efficiently for longer life
- Efficient BL™ Brushless motor is electronically controlled to optimize battery energy use for up to 50% longer run time per charge
- The electronically-controlled BL™ Brushless Motor efficiently uses energy to match torque and RPM to the changing demands of the application

XST01Z Includes: Tool only, battery & charger not included

Hex Shank	1/4"
No Load Speed (var. 3 spd.)	0 - 1,200 / 0 - 2,000 / 0 - 3,200 RPM
Impacts Per Minute (var. 3 spd.)	0 - 1,400 / 0 - 2,200 / 0 - 2,700 IPM
Maximum Torque (in.lbs./N•m)	355 in.lbs./40N•m
Battery	18V LXT® Lithium-Ion
Overall Length	5-3/8"
Net Weight (with battery)	3.2 lbs.
Shipping Weight	2.8 lbs.



LXT

XLTO1

XLTO1Z

18V LXT® Angle Impact Driver Kit

- Makita-built motor delivers 530 in.lbs. of Max Torque
- Variable speed (0-2,000 RPM & 0-3,000 IPM) for a wide range of fastening applications
- Compact 2-1/8" angle head height for use in close quarters
- Large paddle switch with soft grip provides increased comfort
- Long, ergonomic body design provides maximum reach
- Weighs only 3.9 lbs. with battery for reduced operator fatigue

XLTO1 Includes: 18V LXT® Angle Impact Driver (XLTO1Z), (2) 18V LXT® Lithium-Ion 3.0Ah Battery (BL1830B), 18V LXT® Lithium-Ion Rapid Optimum Charger (DC18RC), #2 Phillips Double Ended Bit (784202-3), Tool Bag

XLTO1Z Includes: Tool only, battery & charger not included #2 Phillips Double Ended Bit (784202-3)

Hex Shank	1/4"
No Load Speed (variable speed)	0 - 2,000 RPM
Impacts Per Minute (variable speed)	0 - 3,000 IPM
Maximum Torque (in.lbs./N•m)	530 in.lbs./60N•m
Battery	18V LXT® Lithium-Ion
Overall Length	15-1/4"
Net Weight (with battery)	3.9 lbs.
Shipping Weight	11.8 lbs.



LXT BRUSHLESS HYBRID 4 FUNCTION

XPT02Z

18V LXT® Hybrid Brushless Impact Driver

- Hybrid 4-function tool with impact, hammer, driver and drill all in one
- Efficient BL™ Brushless motor is electronically controlled to optimize battery energy use for up to 50% longer run time per charge
- The BL™ Brushless Motor eliminates carbon brushes, enabling the BL™ Motor to run cooler and more efficiently for longer life
- The electronically-controlled BL™ Brushless Motor efficiently uses energy to match torque and RPM to the changing demands of the application
- Hammer Driver-Drill mode features variable 2-speed operation (0-700 & 0-2,700 RPM) (0-8,400 & 0-32,400 BPM)
- Driver-Drill mode features variable 2-speed operation (0-700 & 0-2,700 RPM) for a wide range of drilling, driving and fastening applications

XPT02Z Includes: Tool only, battery & charger not included

Hex Shank	1/4"
Capacity (steel)	3/8"
Capacity (wood)	13/16"
Capacity (masonry)	5/16"
No Load Speed (var. 2 spd)	0 - 700 / 0 - 2,300 RPM
Blows Per Minute (2 speed)	0 - 8,400 / 0 - 32,400 BPM
No Load Speed (var. 3 spd.)	0 - 1,300 / 0 - 2,200 / 0 - 2,700 RPM
Impacts Per Minute (var. 3 spd.)	0 - 1,200 / 0 - 2,400 / 0 - 3,200 IPM
Maximum Torque (in.lbs./N•m)	1,330 in.lbs./150N•m
Battery	18V LXT® Lithium-Ion
Overall Length	6-3/4"
Net Weight (with battery)	3.9 lbs.
Shipping Weight	3.31 lbs.

740 FT. LBS. OF TORQUE



LXT BRUSHLESS

XWT07T

XWT07Z

18V LXT® Brushless 3/4" Impact Wrench Kit

- BL™ Motor delivers 780 ft.lbs. of fastening torque and 1,250 ft.lbs of breakaway torque
- 3-speed power selection switch (0-900/ 0-1,000/ 0-1,800 RPM & 0-1,800/ 0-2,000/ 0-2,200 IPM) provides precise fastening control
- 3/4" anvil with friction ring and thru hole retention system for maximum productivity
- Efficient BL™ Brushless motor is electronically controlled to optimize battery energy use for up to 50% longer run time per charge
- The BL™ Brushless Motor eliminates carbon brushes, enabling the BL Motor to run cooler and more efficiently for longer life

XWT07T Includes: 18V LXT® Brushless High Torque 3/4" Impact Wrench (XWT07Z), (2) 18V LXT® Lithium-Ion 5.0Ah Battery (BL1850B), 18V LXT® Lithium-Ion Rapid Optimum Charger (DC18RC), Tool Bag

XWT07Z Includes: Tool only, battery & charger not included

Square Drive	3/4"
No Load Speed (var. 3 spd.)	0 - 900 / 0 - 1,000 / 0 - 1,800 RPM
Impacts Per Minute (var. 3 spd.)	0 - 1,800 / 0 - 2,000 / 0 - 2,200 IPM
Maximum Torque (ft.lbs./N•m)	780 ft.lbs./1,057 N•m
Battery	18V LXT® Lithium-Ion
Overall Length	9"
Net Weight (with battery)	8.1 lbs.
Shipping Weight	16.5 lbs.



POWER

BL™ Motor delivers 740 ft.lbs. of fastening torque and 1,180 ft.lbs of breakaway torque

SPEED

3-speed power selection switch (0-900/ 0-1,000/ 0-1,800 RPM) provides precise fastening control

LXT BRUSHLESS

XWT08T

18V LXT® Brushless 1/2" Impact Wrench Kit

- BL™ Motor delivers 740 ft.lbs. of Max Torque and 1,180 ft.lbs of breakaway torque
- 3-speed (0-900/ 0-1,000/ 0-1,800 RPM & 0-1,800/ 0-2,000/ 0-2,200 IPM) for precise fastening control
- Compact and ergonomic design at only 9" long
- 1/2" anvil with friction ring for quick and easy socket changes
- The BL™ Brushless Motor eliminates carbon brushes, enabling the BL Motor to run cooler and more efficiently for longer life
- Efficient BL™ Brushless motor is electronically controlled to optimize battery energy use for up to 50% longer run time per charge
- The electronically-controlled BL™ Brushless Motor efficiently uses energy to match torque and RPM to the changing demands of the application
- Weighs only 7.9 lbs. with battery for reduced operator fatigue

XWT08T Includes: 18V LXT® Brushless High Torque 1/2" Impact Wrench (XWT08Z), (2) 18V LXT® Lithium-Ion 5.0Ah Battery (BL1850B), 18V LXT® Lithium-Ion Rapid Optimum Charger (DC18RC), Tool Bag

XWT08Z Includes: Tool only, battery & charger not included

Square Drive	1/2"
No Load Speed (var. 3 spd.)	0 - 900 / 0 - 1,000 / 0 - 1,800 RPM
Impacts Per Minute (var. 3 spd.)	0 - 1,800 / 0 - 2,000 / 0 - 2,200 IPM
Maximum Torque (ft.lbs./N•m)	740 ft.lbs./1,003 N•m
Battery	18V LXT® Lithium-Ion
Overall Length	9"
Net Weight (with battery)	7.9 lbs.
Shipping Weight	16.5 lbs.



LXT

XWT04TX

XWT04Z

18V LXT® 1/2" Impact Wrench Kit

- Makita-built motor delivers 325 ft.lbs. of Max Torque, with 1,600 RPM and 2,200 IPM for superior fastening power
- Shock absorbent handle protects battery housing for extra durability
- Rocker switch for forward/reverse operation
- Rubberized soft grip handle provides increased comfort on the job
- Compact and ergonomic design at only 10-1/2" long
- Weighs only 7.5 lbs. with battery for reduced operator fatigue

XWT04TX Includes: 18V LXT® 1/2" Impact Wrench (XWT04Z), (2) 18V LXT® Lithium-Ion 5.0Ah Battery (BL1850B), 18V LXT® Lithium-Ion Rapid Optimum Charger (DC18RC), Tool Bag

XWT04Z Includes: Tool only, battery & charger not included

Square Drive	1/2"
No Load Speed	1,600 RPM
Impacts Per Minute	2,200 IPM
Maximum Torque (ft.lbs./N•m)	325 ft.lbs./440 N•m
Battery	18V LXT® Lithium-Ion
Overall Length	10-1/2"
Net Weight (with battery)	7.5 lbs.
Shipping Weight	15.9 lbs.

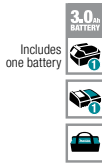

Includes one battery

LXT

XWT041X

XWT04Z

18V LXT® 1/2" Impact Wrench Kit

- Makita-built motor delivers 325 ft.lbs. of Max Torque, with 1,600 RPM and 2,200 IPM for superior fastening power
- Shock absorbent handle protects battery housing for extra durability
- Rocker switch for forward/reverse operation
- Rubberized soft grip handle provides increased comfort on the job
- Compact and ergonomic design at only 10-1/2" long
- Weighs only 7.5 lbs. with battery for reduced operator fatigue

XWT041X Includes: 18V LXT® 1/2" Impact Wrench (XWT04Z), 18V LXT® Lithium-Ion 3.0Ah Battery (BL1830B), 18V LXT® Lithium-Ion Rapid Optimum Charger (DC18RC), Tool Bag

XWT04Z Includes: Tool only, battery & charger not included

Square Drive	1/2"
No Load Speed	1,600 RPM
Impacts Per Minute	2,200 IPM
Maximum Torque (ft.lbs./N•m)	325 ft.lbs./440 N•m
Battery	18V LXT® Lithium-Ion
Overall Length	10-1/2"
Net Weight (with battery)	7.5 lbs.
Shipping Weight	14.4 lbs.



LXT BRUSHLESS

XWT11T

XWT11Z

18V LXT® Brushless 3-Speed 1/2" Impact Wrench Kit

- BL™ Brushless Motor delivers 210 ft.lbs. of Max Torque
- Compact and ergonomic design at only 5-3/4" long
- 3-speed power selection switch (0-1,600 / 0-2,100 / 0-2,800 RPM & 0-1,800 / 0-2,600 / 0-3,500 IPM) for precise fastening control
- Reverse rotation auto-stop mode stops rotation and impact in two seconds when fastener is loosened adequately
- Efficient BL™ Brushless Motor is electronically controlled to optimize battery energy use for up to 50% longer run time per charge

XWT11T Includes: 18V LXT® Brushless 3-Speed 1/2" Impact Wrench (XWT11Z), (2) 18V LXT® Lithium-Ion 5.0Ah Battery (BL1850B), 18V LXT® Lithium-Ion Rapid Optimum Charger (DC18RC), 20" Contractor Tool Bag (831303-9)

XWT11Z Includes: Tool only, battery & charger not included

Square Drive	1/2"
No Load Speed (var. 3 spd.)	0 - 1,600 / 0 - 2,100 / 0 - 2,800 RPM
Impacts Per Minute (var. 3 spd.)	0 - 1,800 / 0 - 2,600 / 0 - 3,500 IPM
Maximum Torque (ft.lbs./N•m)	210 ft.lbs./280 N•m
Battery	18V LXT® Lithium-Ion
Overall Length	5-3/4"
Net Weight (with battery)	3.8 lbs.
Shipping Weight	11.7 lbs.



LXT COMPACT BRUSHLESS

XWT11R

XWT11Z

18V LXT® Compact Brushless 3-Speed 1/2" Impact Wrench Kit

- BL™ Brushless Motor delivers 210 ft.lbs. of Max Torque
- Compact and ergonomic design at only 5-3/4" long
- 3-speed power selection switch (0-1,600 / 0-2,100 / 0-2,800 RPM & 0-1,800 / 0-2,600 / 0-3,500 IPM) for precise fastening control
- Reverse rotation auto-stop mode stops rotation and impact in two seconds when fastener is loosened adequately
- Efficient BL™ Brushless Motor is electronically controlled to optimize battery energy use for up to 50% longer run time per charge
- Weighs only 3.2 lbs. with battery for reduced operator fatigue

XWT11R Includes: (2) 18V LXT® Lithium-Ion Compact 2.0Ah Battery (BL1820B), 18V LXT® Lithium-Ion Rapid Optimum Charger (DC18RC), 20" Contractor Tool Bag (831303-9)

XWT11Z Includes: Tool only, battery & charger not included

Square Drive	1/2"
No Load Speed (var. 3 spd.)	0 - 1,600 / 0 - 2,100 / 0 - 2,800 RPM
Impacts Per Minute (var. 3 spd.)	0 - 1,800 / 0 - 2,600 / 0 - 3,500 IPM
Maximum Torque (ft.lbs./N•m)	210 ft.lbs./280 N•m
Battery	18V LXT® Compact Lithium-Ion
Overall Length	5-3/4"
Net Weight (with battery)	3.2 lbs.
Shipping Weight	8.688 lbs.



LXT

XWT05

XWT05Z

18V LXT® 1/2" Impact Wrench Kit

- Makita-built 4-pole motor delivers 170 ft.lbs. of Max Torque
- 0-2,100 RPM & 0-3,200 IPM for a wide range of fastening applications
- Compact and ergonomic design at only 6-1/2" long
- Weighs only 3.8 lbs. with battery for reduced operator fatigue
- Built-in L.E.D. light illuminates the work area
- Ergonomic shape fits like a glove with even pressure and easy control

XWT05 Includes: 18V LXT® 1/2" Impact Wrench (XWT05Z), (2) 18V LXT® Lithium-Ion 3.0Ah Battery (BL1830), 18V LXT® Lithium-Ion Rapid Optimum Charger (DC18RC), Tool Bag

XWT05Z Includes: Tool only, battery & charger not included

Square Drive	1/2"
No Load Speed (variable speed)	0 - 2,100 RPM
Impacts Per Minute (variable speed)	0 - 3,200 IPM
Maximum Torque (ft.lbs./N•m)	170 ft.lbs./230 N•m
Battery	18V LXT® Lithium-Ion
Overall Length	6-1/2"
Net Weight (with battery)	3.8 lbs.
Shipping Weight	11.15 lbs.



LXT BRUSHLESS

XWT09T

XWT09Z

18V LXT® Brushless 7/16" Hex Impact Wrench Kit

- BL™ Motor delivers 590 ft.lbs. of fastening torque
- 3-speed power selection switch (0-900/ 0-1,000/ 0-1,800 RPM & 0-1,800/ 0-2,000/ 0-2,200 IPM) provides the user with precise fastening control
- Efficient BL™ Brushless motor is electronically controlled to optimize battery energy use for up to 50% longer run time per charge
- The BL™ Brushless Motor eliminates carbon brushes, enabling the BL Motor to run cooler and more efficiently for longer life
- The electronically-controlled BL™ Brushless Motor efficiently uses energy to match torque and RPM to the changing demands of the application

XWT09T Includes: 18V LXT® Brushless High Torque 7/16" Impact Wrench (XWT09T), 18V LXT® Lithium-Ion Rapid Optimum Charger (DC18RC), (2) 18V LXT® Lithium-Ion 5.0Ah Battery (BL1850B), Tool Bag

XWT09Z Includes: Tool only, battery & charger not included

Hex Shank	7/16"
No Load Speed (var. 3 spd.)	0 - 900 / 0 - 1,000 / 0 - 1,800 RPM
Impacts Per Minute (var. 3 spd.)	0 - 1,800 / 0 - 2,000 / 0 - 2,200 IPM
Maximum Torque (ft.lbs./N•m)	590 ft.lbs./800 N•m
Battery	18V LXT® Lithium-Ion
Overall Length	9"
Net Weight (with battery)	8.1 lbs.
Shipping Weight	16.5 lbs.



LXT BRUSHLESS

XWT09XVZ

18V LXT® Brushless High Torque 7/16" Hex Utility Impact Wrench

- Ideal for utility work
- BL™ Brushless Motor delivers 590 ft.lbs. of fastening torque
- 3-speed power selection switch (0-900/ 0-1,000/ 0-1,800 RPM & 0-1,800/ 0-2,000/ 0-2,200 IPM) provides the user with precise fastening control
- The BL™ Brushless Motor eliminates carbon brushes, enabling the BL Motor to run cooler and more efficiently for longer life
- Efficient BL™ Brushless motor is electronically controlled to optimize battery energy use for up to 50% longer run time per charge
- The electronically-controlled BL™ Brushless Motor efficiently uses energy to match torque and RPM to the changing demands of the application

XWT09XVZ Includes: Tool only, battery & charger not included

Hex Shank	7/16"
No Load Speed (var. 3 spd.)	0 - 900 / 0 - 1,000 / 0 - 1,800 RPM
Impacts Per Minute (var. 3 spd.)	0 - 1,800 / 0 - 2,000 / 0 - 2,200 IPM
Maximum Torque (ft.lbs./N•m)	590 ft.lbs./800 N•m
Battery	18V LXT® Lithium-Ion
Overall Length	9"
Net Weight (with battery)	8.1 lbs.
Shipping Weight	7.92 lbs.



LXT

XWT01Z

18V LXT® 7/16" Impact Wrench

- Engineered for drilling and fastening into treated wood utility poles without rotational torque to help maintain balance
- Makita-built motor delivers 325 ft.lbs. of Max Torque, with 1,900 RPM and 2,200 IPM for powerful drilling and fastening
- Convenient quick-change 7/16" hex chuck allows for faster bit changes
- Rocker switch for forward/reverse operation
- Shock absorbent handle protects battery housing for extra durability
- Rubberized soft grip handle provides increased comfort on the job

XWT01Z Includes: Tool only, battery & charger not included

Hex Shank	7/16"
No Load Speed	1,900 RPM
Impacts Per Minute	2,200 IPM
Maximum Torque (ft.lbs./N•m)	325 ft.lbs./440 N•m
Battery	18V LXT® Lithium-Ion
Overall Length	10-3/4"
Net Weight	7.1 lbs.
Shipping Weight	7 lbs.



LXT

XWT06

XWT06Z

18V LXT® 3/8" Impact Wrench Kit

- Makita-built 4-pole motor delivers 155 ft.lbs. of Max Torque
- Variable speed (0-2,100 RPM & 0-3,200 IPM) for a wide range of fastening applications
- Compact and ergonomic design at only 6-1/8" long
- Weighs only 3.4 lbs. with battery for reduced operator fatigue
- Rubberized soft grip handle provides increased comfort on the job
- Built-in L.E.D. light with afterglow illuminates the work area

XWT06 Includes: 18V LXT® 3/8" Impact Wrench (XWT06Z), (2) 18V LXT® Lithium-Ion 3.0Ah Battery (BL1830), 18V LXT® Lithium-Ion Rapid Optimum Charger (DC18RC), Tool Bag

XWT06Z Includes: Tool only, battery & charger not included

Square Drive	3/8"
No Load Speed (variable speed)	0 - 2,100 RPM
Impacts Per Minute (variable speed)	0 - 3,200 IPM
Maximum Torque (ft.lbs./N•m)	155 ft.lbs./210 N•m
Battery	18V LXT® Lithium-Ion
Overall Length	6-1/8"
Net Weight (with battery)	3.4 lbs.
Shipping Weight	9.3 lbs.

SUB-COMPACT

COMPACT

Ultra-compact and ergonomic design at only 5-5/8" and weighs only 2.7 lbs.

APPLICATIONS

Ideal for working in tight spaces and overhead applications

LXT SUB-COMPACT BRUSHLESS

XWT12RB

18V LXT® Sub-Compact Brushless 3/8" Impact Wrench Kit

- BL™ Brushless Motor delivers 130 ft.lbs. of Max Torque and 230 ft.lbs. of Nut-Busting Torque
- Variable 2-speed (0-1,300/0-2,400 RPM & 0-2,000/0-3,600 IPM) provides fastening control for a wide range of applications
- Reverse Rotation Auto-Stop Mode stops rotation and impact when fastener is loosened adequately
- Ultra-compact and ergonomic design at only 5-5/8"
- Weighs only 2.7 lbs. with battery for reduced operator fatigue
- Ideal for working in tight spaces and overhead applications
- Convenient 3/8" square drive for quick socket changes
- Dual L.E.D. lights illuminate the work area
- Extreme Protection Technology (XPT™) is engineered for improved dust and water resistance for operation in harsh conditions



XWT12RB Includes: 18V LXT® Sub-Compact Brushless 3/8" Impact Wrench (XWT12RB), (2) 18V LXT® Lithium-Ion Compact 2.0Ah Battery (BL1820B), 18V LXT® Lithium-Ion Rapid Optimum Charger (DC18RC), 14" Contractor Tool Bag (831253-8)

XWT12RB Includes: Tool only, battery & charger not included

Square Drive	3/8"
No Load Speed (var. 2 spd.)	0 - 1,300 / 0 - 2,400 RPM
Impacts Per Minute (var. 2 spd.)	0 - 2,000 / 0 - 3,600 IPM
Maximum Torque (ft.lbs./N•m)	130 ft.lbs./180 N•m
Nut-Busting Torque (ft.lbs./N•m)	230 ft.lbs./310 N•m
Battery	18V LXT® Lithium-Ion
Overall Length	5-5/8"
Net Weight (with battery)	2.7 lbs.
Shipping Weight	9.4 lbs.



LXT

XLT02

XLT02Z

18V LXT® 3/8" Angle Impact Wrench Kit

- Makita-built motor delivers 44 ft.lbs. of Max Torque
- Variable speed (0-2,000 RPM & 0-3,000 IPM) for a wide range of fastening applications
- Compact 2-1/4" angle head height for use in close quarters
- Long, ergonomic body design provides maximum reach
- Weighs only 3.9 lbs. with battery for reduced operator fatigue
- Large conveniently located paddle switch for comfortable operation

XLT02 Includes: 18V LXT® 3/8" Angle Impact Wrench (XLT02Z), (2) 18V LXT® Lithium-Ion 3.0Ah Battery (BL1830B), 18V LXT® Lithium-Ion Rapid Optimum Charger (DC18RC), Tool Bag

XLT02Z Includes: Tool only, battery & charger not included

Square Drive	3/8"
No Load Speed (variable speed)	0 - 2,000 RPM
Impacts Per Minute (variable speed)	0 - 3,000 IPM
Maximum Torque (ft.lbs./N•m)	44 ft.lbs./60 N•m
Battery	18V LXT® Lithium-Ion
Overall Length	15-1/4"
Net Weight (with battery)	3.3 lbs.
Shipping Weight	11.8 lbs.



LXT PREMIUM BRUSHLESS

XTW01PT

XTW01ZK

18V X2 LXT® (36V) Brushless Shear Wrench Kit

- Two 18V LXT® Lithium-Ion batteries deliver the power and run time for corded demands without leaving the 18V LXT® platform
- Up to 14% faster fastening than Makita corded model 6922NB
- Tightens up to 315 M22 torque control bolts per charge using two LXT® 5.0Ah batteries
- Powerful BL™ Brushless motor delivers 593 ft.lbs. of torque to handle the most demanding applications

XTW01PT Includes: 18V X2 LXT® (36V) Brushless Shear Wrench (XTW01ZK), (2) 18V LXT® Lithium-Ion 5.0Ah Battery (BL1850B), 18V LXT® Lithium-Ion Dual Port Charger (DC18RD), Outer Sleeve, 3/4" (M20) x M37 (764361-9), Outer Sleeve, 7/8" (M22) x M39 (153909-6), Inner Sleeve, 3/4" (M20) x M38 (764419-4), Inner Sleeve, 7/8" (M22) x M39 (764418-6), Screwdriver (783001-0), Shoulder Strap (161347-8), Tool Case

XTW01ZK Includes: Tool only, battery & charger not included

Battery	2X 18V LXT® Lithium-Ion
Bolt Size Capacity (A325)	5/8", 3/4", 7/8"
Bolt Size Capacity (A490)	5/8", 3/4"
No Load Speed	14 RPM
Maximum Torque (ft.lbs./N•m)	593 ft.lbs./804 N•m
Lock-Off Switch	Yes
Electric Brake	Yes
Overall Length	11-5/8"
Net Weight	15.7 lbs.
Shipping Weight	34.62 lbs.



BL MOTOR DELIVERS 0-4,000 RPM

TECHNOLOGY

BL™ Motor delivers 0-4,000 RPM to handle a variety of drywall and framing applications

PRODUCTIVITY

Push Drive™ – motor starts only when the fastener engages for longer run-time and noise reduction



LXT BRUSHLESS PUSH(DRIVE)

NEW XSF03TX2

18V LXT® Brushless 4,000 RPM Drywall Screwdriver Kit with Autofeed Magazine

- Push Drive™ Technology – in lock-on mode the motor starts only when the fastener engages for longer run-time and motor noise reduction
- BL™ Motor delivers 0-4,000 RPM to handle a variety of drywall and framing applications
- Included: Collated Screw Magazine with easy and reliable auto-feed capability is ideal for production drywall hanging
- Collated screw length capacity range from 1" to 2-3/16" for increased versatility
- Optimized contact point geometry for close-to-corner screw positions
- All metal gears and aluminum gear housing for maximum job site durability
- Ergonomically designed rubberized pistol grip with large 2-finger trigger for increased comfort
- Built-in L.E.D. light illuminates the work area

XSF03TX2 Includes: Tool only, battery & charger not included 18V LXT® Brushless 4,000 RPM Drywall Screwdriver (XSF03Z), (2) 18V LXT® Lithium-Ion 5.0Ah Battery (BL1850B), 18V LXT® Lithium-Ion Rapid Optimum Charger (DC18RC), 3" Magnetic Bit Holder (784812-6), Collated Autofeed Screwdriver Magazine (199145-0), Belt Clip (346449-3), Tool Bag, (2) #2 Phillips Power Bit, (2) #2 Square Power Bit

XSF03Z Includes: Tool only, battery & charger not included 3" Magnetic Bit Holder (784812-6), (2) Insert Bit

Bit Type	1/4" Hex
No Load Speed (variable speed)	0 - 4,000 RPM
Collated Screw Capacity	1" - 2-3/16"
Battery	18V LXT® Lithium-Ion
Overall Length	16"
Net Weight (with battery)	4.7 lbs.

5.0 BATTERY



LXT BRUSHLESS PUSH(DRIVE)

NEW XSF03RX2

XSF03Z

18V LXT® Compact Brushless 4,000 RPM Drywall Screwdriver Kit with Autofeed Magazine

- Push Drive™ Technology – in lock-on mode the motor starts only when the fastener engages for longer run-time and motor noise reduction
- BL™ Motor delivers 0-4,000 RPM to handle a variety of drywall and framing applications
- Included: Collated Auto-Feed Screw Magazine with easy and reliable auto-feed capability is ideal for production drywall hanging

XSF03RX2 Includes: 18V LXT® Brushless 4,000 RPM Drywall Screwdriver (XSF03Z), (2) 18V LXT® Lithium-Ion Compact 2.0Ah Battery (BL1820B), 18V LXT® Lithium-Ion Rapid Optimum Charger (DC18RC), 3" Magnetic Bit Holder (784812-6), Collated Autofeed Screwdriver Magazine (199145-0), Belt Clip (346449-3), Tool Bag, (2) #2 Phillips Power Bit, (2) #2 Square Power Bit

XSF03Z Includes: Tool only, battery & charger not included 3" Magnetic Bit Holder (784812-6), (2) Insert Bit

Bit Type	1/4" Hex
No Load Speed (variable speed)	0 - 4,000 RPM
Collated Screw Capacity	1" - 2-3/16"
Battery	18V LXT® Compact Lithium-Ion
Overall Length	16"
Net Weight (with battery)	4.08 lbs.

2.0 BATTERY



AUTOFEED SCREWDRIVER ACCESSORIES

NEW



Magazine only, tool sold separately

199145-0 Collated Autofeed Screwdriver Magazine

- Easy and Reliable Autofeed Capability is Ideal for Production Drywall Hanging
- Collated screw length capacity range from 1" to 2-3/16" for increased versatility
- Optimized contact point shape for close-to-corner screw positions
- Quick attachment and removal of collated magazine
- Screw depth dial adjustment for increased precision
- Screw strip can be released in reverse direction for easy screw clearance
- Compact and ergonomic design at only 8-7/8" long
- Designed for standard 50 screw flat strips

Designed for Makita cordless screwdriver models XSF03, XSF04 and corded screwdriver models FS2200, FS4200, FS6200



5.0 BATTERY



LXT BRUSHLESS PUSH(DRIVE)

XSF03T

XSF03Z

18V LXT® Brushless 4,000 RPM Drywall Screwdriver Kit

- BL™ Brushless Motor delivers 0-4,000 RPM to handle a variety of drywall and framing applications
- Push Drive™ Technology – in lock-on mode the motor starts only when the fastener engages for efficient battery use and increased drywall installation
- Ergonomically designed rubberized pistol grip with large 2-finger trigger for increased comfort
- Adjustable nose piece delivers consistent screw depth
- 3-stage L.E.D. gauge indicates battery charge level
- Built-in L.E.D. light illuminates the work area

XSF03T Includes: 18V LXT® Brushless 4,000 RPM Drywall Screwdriver (XSF03Z), (2) 18V LXT® Lithium-Ion 5.0Ah Battery (BL1850B), 18V LXT® Lithium-Ion Rapid Optimum Charger (DC18RC), 3" Magnetic Bit Holder (784812-6), Tool Case, (2) Insert Bit

XSF03Z Includes: Tool only, battery & charger not included 3" Magnetic Bit Holder (784812-6), (2) Insert Bit

Bit Type	1/4" Hex
No Load Speed (variable speed)	0 - 4,000 RPM
Battery	18V LXT® Lithium-Ion
Overall Length	9-7/8"
Net Weight (with battery)	3.8 lbs.
Shipping Weight	13 lbs.



2.0 BATTERY



LXT COMPACT BRUSHLESS PUSH(DRIVE)

XSF03R

XSF03Z

18V LXT® Compact Brushless 4,000 RPM Drywall Screwdriver Kit

- BL™ Motor delivers 0-4,000 RPM to handle a variety of drywall and framing applications
- Push Drive™ Technology – in lock-on mode the motor starts only when the fastener engages for efficient battery use and increased drywall installation
- Ergonomically designed rubberized pistol grip with large 2-finger trigger for increased comfort
- Adjustable nose piece delivers consistent screw depth
- 3-stage L.E.D. gauge indicates battery charge level
- Built-in L.E.D. light illuminates the work area

XSF03R Includes: 18V LXT® Brushless 4,000 RPM Drywall Screwdriver (XSF03Z), (2) 18V LXT® Lithium-Ion Compact 2.0Ah Battery (BL1820B), 18V LXT® Lithium-Ion Rapid Optimum Charger (DC18RC), 3" Magnetic Bit Holder (784812-6), Tool Case, (2) Insert Bit

XSF03Z Includes: Tool only, battery & charger not included 3" Magnetic Bit Holder (784812-6), (2) Insert Bit

Bit Type	1/4" Hex
No Load Speed (variable speed)	0 - 4,000 RPM
Battery	18V LXT® Compact Lithium-Ion
Overall Length	9-7/8"
Net Weight (with battery)	3.2 lbs.
Shipping Weight	12 lbs.



2.0 BATTERY



LXT BRUSHLESS PUSH(DRIVE)

XSF04R

XSF04Z

18V LXT® Compact Brushless 2,500 RPM Drywall Screwdriver Kit

- Brushless motor delivers 0-2,500 RPM with increased torque to handle high demand fastening applications
- The electronically-controlled BL™ Brushless Motor efficiently uses energy to match torque and RPM to the changing demands of the application
- Push Drive™ Technology – in lock-on mode the motor starts only when the fastener is engaged for a quieter work environment and to save battery power
- Depth adjustable nose piece delivers consistent screw fastening performance

XSF04R Includes: 18V LXT® Brushless 2,500 RPM Drywall Screwdriver (XSF04Z), (2) 18V LXT® Lithium-Ion Compact 2.0Ah Battery (BL1820B), 18V LXT® Lithium-Ion Rapid Optimum Charger (DC18RC), Belt Clip (346449-3), 3" Magnetic Bit Holder (784812-6), (2) #2 Phillips Insert Bit, 1" (784211), Tool Case

XSF04Z Includes: Tool only, battery & charger not included Belt Clip (346449-3), 3" Magnetic Bit Holder (784812-6), (2) Insert Bit

Bit Type	1/4" Hex
No Load Speed (variable speed)	0 - 2,500 RPM
Battery	18V LXT® Compact Lithium-Ion
Overall Length	9-3/8"
Net Weight (with battery)	3.5 lbs.
Shipping Weight	12 lbs.



5.0 BATTERY



LXT BRUSHLESS PUSH(DRIVE)

XSF05T

XSF05Z

18V LXT® Brushless 2,500 RPM Screwdriver Kit

- Brushless motor delivers 0-2,500 RPM with increased torque to handle high demand fastening applications
- The electronically-controlled BL™ Brushless Motor efficiently uses energy to match torque and RPM to the changing demands of the application
- Push Drive™ Technology – in lock-on mode the motor starts only when the fastener is engaged for a quieter work environment and to save battery power
- Depth adjustable nose piece with 5/16" nutsetter delivers consistent screw fastening performance

XSF05T Includes: 18V LXT® Brushless 2,500 RPM Screwdriver (XSF05Z), (2) 18V LXT® Lithium-Ion 5.0Ah Battery (BL1850B), 18V LXT® Lithium-Ion Rapid Optimum Charger (DC18RC), Belt Clip (346449-3), 5/16" Magnetic Nutsetter, 2-5/8" (784804-5), Tool Case

XSF05Z Includes: Tool only, battery & charger not included 5/16" Magnetic Nutsetter, 2-5/8" (784804-5), Belt Clip (346449-3)

Bit Type	1/4" Hex
No Load Speed (variable speed)	0 - 2,500 RPM
Battery	18V LXT® Lithium-Ion
Overall Length	9-3/8"
Net Weight (with battery)	3.9 lbs.
Shipping Weight	13 lbs.



Screws not included

LXT
XRF02Z

18V LXT® Autofeed Screwdriver

- Makita-built 4-pole motor delivers superior fastening speed with 4,000 RPM for decking and sub-floor applications
- High collated screw capacity range: 1" to 2-1/8"
- Screw guide prevents screw strip tangling and can fold against the autofeed housing for easy storing
- Rugged aluminum dust-proof autofeed housing provides smooth sliding action
- Compact and ergonomic design at only 16-1/4" long
- Weighs only 5.1 lbs. with battery (battery not included) for reduced operator fatigue

XRF02Z Includes: Tool only, battery & charger not included
#2 Phillips Power Bit, 6-3/8" (B-10481-1), (2) #2 Square Power Bit, 6-3/8" (784645-9), Extension Handle (194500-1)

Bit Type	1/4" Hex
No Load Speed	4,000 RPM
Collated Screw Capacity	1" - 2-3/16"
Battery	18V LXT® Lithium-Ion
Overall Length	16-3/4"
Net Weight (with battery)	4.6 lbs.
Shipping Weight	5.1 lbs.



Screws not included

LXT
XRF01Z

18V LXT® Autofeed Screwdriver

- Makita-built 4-pole motor delivers superior fastening speed with 4,000 RPM for decking and sub-floor applications
- High collated screw capacity range: 1-3/4" to 2-15/16"
- Screw guide prevents screw strip tangling and can fold against the autofeed housing for easy storing
- Rugged aluminum dust-proof autofeed housing provides smooth sliding action
- Compact and ergonomic design at only 18-1/4" long
- Weighs only 5.2 lbs. with battery (battery not included) for reduced operator fatigue

XRF01Z Includes: Tool only, battery & charger not included
(3) #2 Phillips Power Bit (B-10475-1), Extension Handle (194500-1)

Bit Type	1/4" Hex
No Load Speed	4,000 RPM
Collated Screw Capacity	1-3/4" - 2-15/16"
Battery	18V LXT® Lithium-Ion
Overall Length	18-1/4"
Net Weight (with battery)	5.2 lbs.
Shipping Weight	5.1 lbs.



Also Available:
Dust Extracting
Cut-Out Base
193449-2

LXT
XOC01T

18V LXT® Cut-Out Tool Kit

- Makita-built motor delivers 30,000 RPM for faster cutting
- Slide switch with lock-on for operator convenience
- On board bit change capabilities eliminates need for wrench
- Quick and easy "tool-less" depth adjustment
- Slim body design (2-1/4" diameter) for comfort and precision
- Large and conveniently located shaft lock button for fast bit changes

XOC01T Includes: 18V LXT® Cut-Out Tool (XOC01Z), (2) 18V LXT® Lithium-Ion 5.0Ah Battery (BL1850B), 18V LXT® Lithium-Ion Rapid Optimum Charger (DC18RC), 1/8" Cut-Out Bit (193446-8), Spanner Wrench (781008-0), Tool Bag

XOC01Z Includes: Tool only, battery & charger not included
(2) 1/8" Cut-Out Bit (193446-8), Spanner Wrench (781008-0)

Collet Capacity	1/8", 1/4"
No Load Speed	30,000 RPM
Battery	18V LXT® Lithium-Ion
Overall Length	12-3/8"
Net Weight (with battery)	3.7 lbs.
Shipping Weight	17 lbs.



LXT
XDS01Z

18V LXT® Cut-Out Saw

- Makita-built variable speed motor delivers 0-6,000 strokes per minute for faster and more efficient cutting
- Designed to cut openings in installed board with an adjustable blade depth up to 1-3/16" (9/16" in wood)
- Cuts up to 984 feet of 1/2" drywall on a single charge using 4.0Ah battery BL1840B (battery not included)*
- Short 1/4" stroke length with adjustable blade depth helps prevent damage to objects behind the board being cut
- Clear dust box for dust containment with increased visibility for operator convenience
- Dual L.E.D. lights with afterglow illuminate the work area

XDS01Z Includes: Tool only, battery & charger not included
Cut-Out Saw Blade, Drywall (B-49703-1)

Max. Cutting Capacity (drywall)	1-3/16"
Max. Cutting Capacity (wood)	9/16"
Strokes Per Minute (variable speed)	0 - 6,000 SPM
Battery	18V LXT® Lithium-Ion
Overall Length	9-1/8"
Length of Stroke	1/4"
Net Weight (with battery)	4.2 lbs.
Shipping Weight	3.8 lbs.

*Hardness of drywall may effect run time performance



Includes one battery

LXT
XGC01T1

18V LXT® 10 oz. Caulk and Adhesive Gun Kit

- Makita-built motor delivers 1,100 lbs. of dispensing force to dispense the highest viscosity adhesives and sealants
- 5-speed dial optimizes flow rate from 0-66 IPM
- Variable speed trigger allows user match speed to the application
- 360° rotatable cartridge holder fits 10 oz. and 300 ml cartridges
- Drip-reduction feature automatically relieves pressure to the material when trigger is released to prevent unintentional dispensing

XGC01T1 Includes: 18V LXT® 10 oz. Caulk and Adhesive Gun (XGC01Z), 18V LXT® Lithium-Ion 5.0Ah Battery (BL1850B), 18V LXT® Lithium-Ion Rapid Optimum Charger (DC18RC), Tool Bag

XGC01Z Includes: Tool only, battery & charger not included

Capacity (caulk or sealants)	10 oz.
Dispense Force	1,100 lbs.
Inches Per Minute (variable speed)	0 - 66 IPM
Speed Settings	5
Battery	18V LXT® Lithium-Ion
Overall Length	15-7/8"
Net Weight (with battery)	13.1 lbs.
Shipping Weight	12.6 lbs.



Includes one battery

LXT
XGC01T1B

18V LXT® 20 oz. Barrel Style Caulk and Adhesive Gun Kit

- Makita-built motor delivers 1,100 lbs. of dispensing force to dispense the highest viscosity adhesives and sealants
- 5-speed dial optimizes flow rate from 0-66 IPM
- Variable speed trigger allows user match speed to the application
- 360° rotatable cartridge holder fits 20 oz. cartridges, sausage packs and bulk caulk and adhesives
- Includes 3 pistons for use with cartridges, sausage packs and bulk materials
- Drip-reduction feature automatically relieves pressure on the material when trigger is released to prevent unintentional dispensing

XGC01T1B Includes: 18V LXT® 20 oz. Barrel Style Caulk and Adhesive Gun (XGC01ZB), 18V LXT® Lithium-Ion 5.0Ah Battery (BL1850B), 18V LXT® Lithium-Ion Rapid Optimum Charger (DC18RC)

XGC01ZB Includes: Tool only, battery & charger not included

Capacity (caulk or sealants)	20 oz.
Dispense Force	1,100 lbs.
Inches Per Minute (variable speed)	0 - 66 IPM
Speed Settings	5
Battery	18V LXT® Lithium-Ion
Overall Length	21-1/4"
Net Weight (with battery)	6 lbs.
Shipping Weight	12 lbs.



Includes one battery

LXT
XGC01T1C

18V LXT® 29 oz. Caulk and Adhesive Gun Kit

- 5-speed dial optimizes flow rate from 0-66 IPM
- Variable speed trigger allows user to match speed to the application
- 360° rotatable cartridge holder fits 29 oz. cartridges
- Drip-reduction feature automatically relieves pressure on the material when trigger is released to prevent unintentional dispensing
- Overload indicator light notifies the operator when tool is nearly overloaded to minimize breakage of the sealant cartridge
- Compact and ergonomic design at 18-7/8" long

XGC01T1C Includes: 18V LXT® 29 oz. Caulk and Adhesive Gun (XGC01ZC), 18V LXT® Lithium-Ion 5.0Ah Battery (BL1850B), 18V LXT® Lithium-Ion Rapid Optimum Charger (DC18RC), Tool Bag (831271-6), Holder C (455951-6), Holder Joint C (143223-8), Piston D (143221-2), Rod (143220-4)

XGC01ZC Includes: Tool only, battery & charger not included

Capacity (caulk or sealants)	29 oz.
Dispense Force	1,100 lbs.
Inches Per Minute (variable speed)	0 - 66 IPM
Speed Settings	5
Battery	18V LXT® Lithium-Ion
Overall Length	18-7/8"
Net Weight (with battery)	5.9 lbs.
Shipping Weight	13.6 lbs.

CAULKING GUN ACCESSORIES



196351-8
10 oz. Cartridge Holder Set
360° rotatable cartridge holder fits 10 oz. and 300 ml cartridges



196352-6
20 oz. Barrel Holder Set
Holds 20 oz. cartridge style, sausage style and bulk caulks and adhesives



197195-9
29 oz. Cartridge Holder Set
Complete set includes all you need to utilize 29oz. cartridge style containers



LXT

NEW XNB02RJ

XNB02Z

18V LXT® 2-1/2" Straight Finish Nailer Kit, 16 Ga.

- Powerful motor design drives standard 16 gauge, straight finish nails from 1" to 2-1/2" in length
- Compact center height enables viewing around the nose tip when fastening in tight spots
- Narrow nose design allows easy nailing access in confined areas
- Nail length markings and large windows on the magazine for easy checking of nails
- Anti-dry fire mechanism engineered to help prevent driving blanks and damage to work surface

XNB02RJ Includes: 18V LXT® 2-1/2" Straight Finish Nailer, 16 Gauge (XNB02Z), 18V LXT® Lithium-Ion Rapid Optimum Charger (DC18RC), (2) 18V LXT® Lithium-Ion Compact 2.0Ah Battery (BL1820B), Interlocking Case, X-Large (197213-3), (2) No-Mar Tip (424443-6), Safety Glasses, Belt Clip

XNB02Z Includes: Tool only, battery & charger not included (2) No-Mar Tip (424443-6), Safety Glasses, Belt Clip

Battery	18V LXT® Lithium-Ion
Fastening category	Finish
Nail Size	1" to 2-1/2" (16 ga.)
Maximum Magazine Capacity	110
Dimensions (LxWxH)	11-5/8" x 4-1/4" x 12-1/2"
Net Weight (with battery)	7.5 lbs.
Shipping Weight	20.57 lbs.



LXT

XNB01Z

18V LXT® 2" Brad Nailer, 18 Gauge

- Drives up to 1,660 finish nails using a 5.0Ah 18V LXT® Battery (battery not included)*
- Drives a range of 18 gauge brad nails from 5/8" to 2"; magazine capacity up to 100 nails
- 2-mode selector switch for control of nailing operation
- "Tool-less" depth adjustment for precise flush and countersink finish
- Anti-dry drive mechanism engineered to prevent driving blanks and damage to work surface
- Battery gauge indicates battery charge level

XNB01Z Includes: Tool only, battery & charger not included

Battery	18V LXT® Lithium-Ion
Nail Size	5/8" to 2" (18 ga.)
Maximum Magazine Capacity	100
Fastening category	Brad
Dimensions (LxWxH)	11-5/8" x 3-13/16" x 12-1/2"
Net Weight (with battery)	7.7 lbs.
Shipping Weight	8 lbs.

*Attaching plywood to Douglas fir with 5/8" to 2" nail



LXT

XTP02Z

18V LXT® 1-3/8" Pin Nailer, 23 Gauge

- Drives 6 different lengths, 5/8", 11/16", 3/4", 1", 1-3/16" and 1-3/8", of 23 gauge pin nails (tool does not work with 1-1/4" pin nails)
- Magazine capacity up to 120 pin nails
- Refined firing mechanism reduces recoil; reduces force required on the work surface when driving pin nails
- "Tool-less" depth adjustment for precise flush and countersink finish
- Anti-dry fire mechanism engineered to prevent driving blanks and damage to work surface
- Compact and ergonomic design at only 10-1/8" long

XTP02Z Includes: Tool only, battery & charger not included Safety Glasses (195246-2), (2) Nose No-Mar Tip, XTP02 (424955-9), Belt Clip (346449-3), Hex Wrench 3 (783201-2)

Battery	18V LXT® Lithium-Ion
Nail Size	5/8", 11/16", 3/4", 1", 1-3/16", 1-3/8" (23 ga.)
Maximum Magazine Capacity	120
Fastening category	Pin
Dimensions (LxWxH)	10-1/8" x 3-1/8" x 8-7/8"
Net Weight (with battery)	4 lbs.
Shipping Weight	4.7 lbs.



LXT

XTS01T

XTS01Z

18V LXT® 3/8" Crown Stapler Kit

- Fastens a wide range of 3/8" crown staples from 3/8" to 7/8" in length; also utilizes Arrow® T50 type flat crown staples
- A convenient window on magazine shows the number of remaining staples
- Spring-loaded driving mechanism allows for a more compact tool with less weight
- Contact actuation is well-suited for production environment
- Rugged machined aluminum magazine ensures smooth loading and feeding of staples
- Easy to use depth control setting by turning adjustment knob

XTS01T Includes: 18V LXT® 3/8" Crown Stapler (XTS01Z), (2) 18V LXT® Lithium-Ion 5.0Ah Battery (BL1850B), 18V LXT® Lithium-Ion Rapid Optimum Charger (DC18RC), Tool Bag

XTS01Z Includes: Tool only, battery & charger not included

Battery	18V LXT® Lithium-Ion
Crown	3/8"
Gauge	T50® Style
Leg Length	3/8" to 7/8"
Maximum Magazine Capacity	98
Fastening category	Stapler
Dimensions (LxWxH)	9-7/8" x 3-5/8" x 8-3/8"
Net Weight (with battery)	5.3 lbs.
Shipping Weight	13.6 lbs.

SAWS

THE ADVANCED STANDARD

EXCEEDING YOUR CORDED SAW EXPECTATIONS

LXT X2 18V + 18V 36V BRUSHLESS

AWS CAPABLE



NEW XSH07PTU

XSH07ZU

18V X2 LXT® (36V) Brushless 7-1/4" Circular Saw Kit, AWS™ Capable

- X2 LXT® technology delivers up to 610 crosscuts per charge in 2x4 SPF lumber using two 5.0Ah batteries
- Auto-Start Wireless System (AWS™) utilizes Bluetooth® technology for wireless power-on/off communication between tool and optional dust extractor
- AWS™ capable with Auto-Start Wireless Transmitter (part no. 198901-5) sold separately
- Automatic Speed Change™ technology adjusts cutting speed and torque during cut for optimum performance
- Extreme Protection Technology (XPT™) is engineered for improved dust and water resistance for operation in harsh conditions
- Large 2-5/8" cutting capacity at 90°
- Electric brake for maximum productivity
- 0°-56° bevel capacity with positive stops at 22.5°, 45°, and 56°
- Die-cast magnesium base, blade guard, and blade cover provide a lightweight, durable design

XSH07PTU Includes: 18V LXT® Lithium-Ion Dual Port Charger (DC18RD), (2) 18V LXT® Lithium-Ion 5.0Ah Battery (BL1850B), 7-1/4" 24T C.T. Circular Saw Blade (B-61656), Wrench (783204-6), Tool Bag (831271-6), Dust Extracting Attachment (196520-1)

XSH07ZU Includes: Tool only, battery & charger not included 7-1/4" 24T C.T. Circular Saw Blade (B-61656), Wrench (783204-6), Dust Extracting Attachment (196520-1)

Blade Diameter	7-1/4"
Arbor	5/8"
No Load Speed	6,000 RPM
Max. Cutting Capacity (at 45°)	1-13/16"
Max. Cutting Capacity (at 50°)	1-5/16"
Max. Cutting Capacity (at 90°)	2-5/8"
Battery	2X 18V LXT® Lithium-Ion
Overall Length	13-1/2"
Net Weight (with battery)	10.5 lbs.
Power Type	Cordless
Built-in light	Yes
Shipping Weight	

TECHNOLOGY

Auto-Start Wireless System (AWS™) capable; optional AWS™ Transmitter sold separately



PERFORMANCE

Delivers up to 610 crosscuts per charge in 2x4 SPF using two LXT® 5.0Ah batteries



WORLD'S FIRST CORDLESS 7-1/4" REAR HANDLE CIRCULAR SAW



LXT BRUSHLESS

XSH06PT XSH06Z

18V X2 LXT® (36V) Brushless 7-1/4" Circular Saw Kit

- X2 LXT® technology delivers up to 610 crosscuts per charge in 2x4 SPF lumber using two 5.0Ah batteries
- Automatic Speed Change™ technology adjusts cutting speed and torque during cut for optimum performance
- Extreme Protection Technology (XPT™) is engineered for improved dust and water resistance for operation in harsh conditions
- Large 2-5/8" cutting capacity at 90°
- Electric brake for maximum productivity
- 0°-56° bevel capacity with positive stops at 22.5°, 45°, and 56°

XSH06PT Includes: 18V X2 LXT® (36V) Brushless 7-1/4" Circular Saw (XSH06Z), (2) 18V LXT® Lithium-Ion 5.0Ah Battery (BL1850B), 18V LXT® Lithium-Ion Dual Port Charger (DC18RD), 7-1/4" 24T C.T. Circular Saw Blade (B-61656), Wrench (783204-6), Dust Extracting Attachment (196520-1)

XSH06Z Includes: Tool only, battery & charger not included 7-1/4" 24T C.T. Circular Saw Blade (B-61656), Wrench (783204-6), Dust Extracting Attachment (196520-1)

Blade Diameter	7-1/4"
Arbor	5/8"
No Load Speed	6,000 RPM
Max. Cutting Capacity (at 45°)	1-13/16"
Max. Cutting Capacity (at 50°)	1-5/16"
Max. Cutting Capacity (at 90°)	2-5/8"
Battery	2X 18V LXT® Lithium-Ion
Overall Length	13-1/2"
Net Weight (with battery)	10.5 lbs.
Shipping Weight	21.21 lbs.

INNOVATION
Brushless Motor delivers 5,100 RPM for maximum performance and 50% longer run time per charge

PERFORMANCE
Delivers up to 558 cross-cuts per charge in 2x4 SPF using two LXT® 5.0Ah batteries

LXT BRUSHLESS

XSR01PT

18V X2 LXT® (36V) Brushless Rear Handle 7-1/4" Circular Saw Kit

- X2 LXT® technology delivers up to 558 cross-cuts per charge in 2x4 SPF lumber using two 5.0Ah batteries
- Large 2-9/16" cutting capacity at 90°; cuts 3X material in a single pass
- Automatic Speed Change™ technology adjusts cutting speed and torque during cut for optimum performance
- Electric brake for maximum productivity
- 0°-53° bevel capacity with positive stops at 22.5°, 45°, and 53°
- Die-cast magnesium base and blade guard along with a die-cast aluminum blade cover and motor housing provide a lightweight, durable design
- Retractable, extra-wide tool hook secures the tool when not in use
- Built-in tether notch (tether sold separately)

XSR01PT Includes: 18V X2 LXT® (36V) Brushless Rear Handle 7-1/4" Circular Saw (XSR01Z), (2) 18V LXT® Lithium-Ion 5.0Ah Battery (BL1850B), 18V LXT® Lithium-Ion Dual Port Charger (DC18RD), 7-1/4" 24T Ultra-Coated C.T. Saw Blade (A-94530-A), Wrench (783204-6), Tool Bag (831271-6)

XSR01Z Includes: Tool only, battery & charger not included 7-1/4" 24T Ultra-Coated C.T. Saw Blade (A-94530-A), Wrench (783204-6)

Blade Diameter	7-1/4"
Arbor	5/8"
Max. Cutting Capacity (at 90°)	2-9/16"
Max. Cutting Capacity (at 45°)	1-3/4"
Max. Cutting Capacity (at 53°)	1-1/2"
No Load Speed	5,100 RPM
Battery	2X 18V LXT® Lithium-Ion
Overall Length	17-1/2"
Net Weight (with battery)	12.4 lbs.
Shipping Weight	24.2 lbs.



LXT BRUSHLESS

XSH03T XSH03Z

18V LXT® Brushless 6-1/2" Circular Saw Kit

- Powerful Makita built electronically controlled BL™ Motor delivers 5,000 RPM for faster cutting and ripping
- Automatic Speed Change™ technology adjusts speed and torque during operation for optimum performance
- Compact and ergonomic blade-left design at only 13-3/4" long
- Weighs only 7.3 lbs. with battery for reduced operator fatigue
- Large cutting capacity (2-1/4" at 90°) and bevel capacity (0°-50°)
- Only use genuine Makita batteries and chargers

XSH03T Includes: 18V LXT® Brushless 6-1/2" Circular Saw (XSH03Z), (2) 18V LXT® Lithium-Ion 5.0Ah Battery (BL1850B), 18V LXT® Lithium-Ion Rapid Optimum Charger (DC18RC), 6-1/2" 24T C.T. Saw Blade (A-85092), Tool bag

XSH03Z Includes: Tool only, battery & charger not included 6-1/2" 24T C.T. Saw Blade (A-85092)

Blade Diameter	6-1/2"
Arbor	5/8"
Max. Cutting Capacity (at 90°)	2-1/4"
Max. Cutting Capacity (at 45°)	1-5/8"
Max. Cutting Capacity (at 50°)	1-7/16"
No Load Speed	5,000 RPM
Battery	18V LXT® Lithium-Ion
Overall Length	13-3/4"
Net Weight (with battery)	7.3 lbs.
Shipping Weight	15.7 lbs.

THE MOST COMPACT

ERGONOMICS

Compact and ergonomic blade-right design at only 10-5/8" long and 6.4 lbs.

PERFORMANCE

Delivers up to 174 crosscuts per charge in 2x10 SPF using one 5.0Ah battery (battery not included)

LXT SUB-COMPACT BRUSHLESS

XSH05ZB

18V LXT® Sub-Compact Brushless 6-1/2" Circular Saw, AWS™ Capable

- Auto-Start Wireless System (AWS™) utilizes Bluetooth® technology for wireless power-on/off communication between tool and optional dust extractor
- AWS™ capable with Auto-Start Wireless Transmitter (part no. 198901-5) sold separately
- Compact and ergonomic blade-right design at only 10-5/8" long
- Weighs only 6.4 lbs. with 2.0Ah battery (battery not included) for operator comfort
- Powerful Makita built electronically controlled BL™ Motor delivers 5,000 RPM for faster cutting and ripping
- The BL™ Brushless Motor eliminates carbon brushes, enabling the BL™ Motor to run cooler and more efficiently for longer life
- Large cutting capacity (2-1/4" at 90°) and bevel capacity (0°-50°)
- LXT® technology delivers up to 174 crosscuts per charge in 2x10 SPF lumber using one 5.0Ah battery (battery not included)

XSH05ZB Includes: Tool only, battery & charger not included 6-1/2" 24T C.T. Saw Blade (A-85092), Dust Extracting Attachment (199230-9), Hex Wrench (783203-8)

Blade Diameter	6-1/2"
Arbor	5/8"
No Load Speed	5,000 RPM
Max. Cutting Capacity (at 90°)	2-1/4"
Max. Cutting Capacity (at 45°)	1-5/8"
Overall Length	10-5/8"
Net Weight (with battery)	6.4 lbs.
Blade Location	Right
Automatic-start Wireless System (AWS™) Capable (transmitter sold separately)	
Shipping Weight	7.5 lbs.



LXT BRUSHLESS

XSH04RB XSH04ZB

18V LXT® Sub-Compact Brushless 6-1/2" Circular Saw Kit

- Compact and ergonomic blade-right design at only 10-5/8" long
- Weighs only 6.4 lbs. with battery for operator comfort
- Powerful Makita built electronically controlled BL™ Motor delivers 5,000 RPM for faster cutting and ripping
- The BL™ Brushless Motor eliminates carbon brushes, enabling the BL™ Motor to run cooler and more efficiently for longer life
- Large cutting capacity (2-1/4" at 90°) and bevel capacity (0°-50°)

XSH04RB Includes: 18V LXT® Sub-Compact Brushless 6-1/2" Circular Saw (XSH04ZB), (2) 18V LXT® Lithium-Ion Compact 2.0Ah Battery (BL1820B), 18V LXT® Lithium-Ion Rapid Optimum Charger (DC18RC), 6-1/2" 24T C.T. Saw Blade (A-85092), Hex Wrench (783203-8), Dust Extracting Attachment (199230-9)

XSH04ZB Includes: Tool only, battery & charger not included 6-1/2" 24T C.T. Saw Blade (A-85092), Dust Extracting Attachment (199230-9), Hex Wrench (783203-8)

Blade Diameter	6-1/2"
Arbor	5/8"
No Load Speed	5,000 RPM
Max. Cutting Capacity (at 90°)	2-1/4"
Max. Cutting Capacity (at 45°)	1-5/8"
Overall Length	10-5/8"
Net Weight (with battery)	6.4 lbs.
Blade Location	Right



LXT

XSS03Z

18V LXT® 5-3/8" Circular Trim Saw

- Makita-built motor delivers 3,600 RPM for faster cutting and ripping through wood
- Weighs only 6.0 lbs. with battery (battery not included) for reduced operator fatigue
- Built-in dust blower keeps the line of cut free of debris for more accurate cuts
- Heavy gauge, precision machined base for smooth, accurate cutting and added durability
- Electric brake for maximum productivity
- Built-in L.E.D. light illuminates the work area

XSS03Z Includes: Tool only, battery & charger not included 5-3/8" 16T C.T. Saw Blade (A-94904), Rip Fence (164095-8), Hex Wrench (783203-8)

Blade Diameter	5-3/8"
Arbor	5/8"
Max. Cutting Capacity (at 90°)	2"
Max. Cutting Capacity (at 45°)	1-3/8"
No Load Speed	3,600 RPM
Battery	18V LXT® Lithium-Ion
Overall Length	14-3/8"
Net Weight (with battery)	6 lbs.
Shipping Weight	8.1 lbs.



LXT BRUSHLESS

XPS01PTJ

XPS01Z

18V X2 LXT® (36V) Brushless 6-1/2" Plunge Circular Saw Kit

- X2 LXT® technology delivers up to 125 cuts per charge in 4x8 sheets of 1/2" plywood per charge using two 5.0Ah batteries
- Ideal for large wood, other wood materials like melamine and MDF, aluminum, and Corian® (includes wood blade, other blades sold separately)
- Built-in depth stop allows a preliminary first cut for clean and splinter-free cutting prior to the full cutting of sheet
- Slide lever on saw base designed to engage the optional guide rail (sold separately) when bevel cutting for stability

XPS01PTJ Includes: 18V X2 LXT® (36V) Brushless 6-1/2" Plunge Circular Saw (XPS01Z), (2) 18V LXT® Lithium-Ion 5.0Ah Battery (BL1850B), 18V LXT® Lithium-Ion Dual Port Charger (DC18RD), 6-1/2" 56T C.T. Cordless Plunge Saw Blade, Wood, MDF, Lam. (B-57071), Hex Wrench (783203-8), Interlocking Case, X-Large (197213-3), Interlocking Case, Medium (197211-7)

XPS01Z Includes: Tool only, battery & charger not included Hex Wrench (783203-8), 6-1/2" C.T. Cordless Plunge Saw Blade, Wood, MDF, Lam.

Blade Diameter	6-1/2"
Arbor (mm)	20 mm
Max. Cutting Capacity (at 90°)	2-3/16"
Max. Cutting Capacity (at 45°)	1-9/16"
No Load Speed (variable speed)	2,500 - 6,300 RPM
Battery	2X 18V LXT® Lithium-Ion
Overall Length	13-5/8"
Net Weight (with battery)	11.2 lbs.
Shipping Weight	28 lbs.



LXT BRUSHLESS AWS

XPS02PTU

XPS02Z

18V X2 LXT® (36V) Brushless 6-1/2" Plunge Circular Saw Kit, AWS™

- Auto-Start Wireless System (AWS™) utilizes Bluetooth® technology for wireless power-on/off communication between tool and optional dust extractor
- X2 LXT® technology delivers up to 125 cuts per charge in 4x8 sheets of 1/2" plywood per charge using two 5.0Ah batteries
- Ideal for large wood panels, other wood materials like melamine and MDF, aluminum, and Corian® (includes wood blade, other blades sold separately)

XPS02PTU Includes: 18V LXT® Lithium-Ion Dual Port Charger (DC18RD), (2) 18V LXT® Lithium-Ion 5.0Ah Battery (BL1850B), Interlocking Case, X-Large (197213-3), Interlocking Case, Medium (197211-7), 6-1/2" 56T C.T. Cordless Plunge Saw Blade, Wood, MDF, Laminate (B-57342), Auto-Start Wireless Transmitter (198901-5), Hex Wrench (783203-8)

XPS02Z Includes: Tool only, battery & charger not included 6-1/2" 56T C.T. Cordless Plunge Saw Blade, Wood, MDF, Laminate (B-57342), Auto-Start Wireless Transmitter (198901-5), Hex Wrench (783203-8)

Blade Diameter	6-1/2"
Arbor (mm)	20 mm
Max. Cutting Capacity (at 90°)	2-3/16"
Max. Cutting Capacity (at 45°)	1-9/16"
No Load Speed (variable speed)	2,500 - 6,300 RPM
Battery	2X 18V LXT® Lithium-Ion
Overall Length	13-5/8"
Net Weight (with battery)	11.2 lbs.
Shipping Weight	19 lbs. Automatic-start Wireless System (AWS™) Yes (Transmitter Included)



LXT

XSS01T

XSS01Z

18V LXT® 6-1/2" Circular Saw Kit

- Makita-built motor delivers 3,700 RPM for faster cutting and ripping through wood
- Built-in L.E.D. light illuminates the work area
- 50° maximum bevel cutting capacity
- Built-in dust blower keeps the line of cut free of debris for more accurate cuts
- Heavy gauge, precision machined base for smooth, accurate cutting and added durability
- Electric brake for maximum productivity

XSS01T Includes: 18V LXT® 6-1/2" Circular Saw (XSS01Z), (2) 18V LXT® Lithium-Ion 5.0Ah Battery (BL1850B), 18V LXT® Lithium-Ion Rapid Optimum Charger (DC18RC), 6-1/2" 24T C.T. Saw Blade (A-85092), Rip Fence (164095-8), Tool Case (824757-7)

XSS01Z Includes: Tool only, battery & charger not included 6-1/2" 24T C.T. Saw Blade (A-85092), Rip Fence (164095-8)

Blade Diameter	6-1/2"
Arbor	5/8"
Max. Cutting Capacity (at 90°)	2-1/4"
Max. Cutting Capacity (at 45°)	1-9/16"
No Load Speed	3,700 RPM
Battery	18V LXT® Lithium-Ion
Overall Length	13-5/8"
Net Weight (with battery)	7.6 lbs.
Shipping Weight	19 lbs.



LXT

XSS02Z

18V LXT® 6-1/2" Circular Saw

- Makita-built motor delivers 3,700 RPM for faster cutting
- Heavy gauge machined base for smooth and accurate cutting
- 50° maximum bevel cutting capacity
- Weighs only 7.3 lbs. with battery (battery not included) for reduced operator fatigue.
- 6-1/2" blade delivers a 2-1/4" cutting capacity for a wide range of cutting applications
- Rubberized soft grip handle provides increased comfort on the job

XSS02Z Includes: Tool only, battery & charger not included TCT SAW BLADE 165X15.86X16T (A-96023)

Blade Diameter	6-1/2"
Arbor	5/8"
Max. Cutting Capacity (at 90°)	2-1/4"
Max. Cutting Capacity (at 45°)	1-9/16"
No Load Speed	3,700 RPM
Battery	18V LXT® Lithium-Ion
Overall Length	13-5/8"
Net Weight (with battery)	7.3 lbs.
Shipping Weight	8.38 lbs.



LXT BRUSHLESS

XVJ01Z

18V LXT® Brushless Barrel Grip Jig Saw

- Makita-built brushless motor and 3 orbital settings plus straight cutting deliver faster and more accurate cuts in a variety of materials
- Variable 6-speed control dial (800-3,500 SPM) enables user to match the speed to the application
- "Tool-less" blade change system allows for faster blade installation and removal for increased productivity
- Dual L.E.D. lights illuminate the work area
- Dual ambidextrous On/Off button with separate lock button
- Built-in dust blower clears the line of cut for increased accuracy

XVJ01Z Includes: Tool only, battery & charger not included Anti-Splintering Insert (415524-7), Cover Plate (417852-6), Hex Wrench (783202-0), Jig Saw Blade

Max. Cutting Capacity at 90° (wood)	5-5/16"
Max. Cutting Capacity at 90° (mild steel)	3/8"
Max. Cutting Capacity at 90° (aluminum)	25/32"
Strokes Per Minute (variable speed)	800 - 3,500 SPM
Blade Shank	"T" Tang
Power Type	Cordless
Battery	18V LXT® Lithium-Ion
Overall Length	11-3/4"
Net Weight (with battery)	5.5 lbs.
Shipping Weight	5.12 lbs.



LXT BRUSHLESS

XVJ02Z

18V LXT® Brushless Jig Saw

- Makita-built brushless motor and 3 orbital settings plus straight cutting deliver faster and more accurate cuts in a variety of materials
- Variable 6-speed control dial (800-3,500 SPM) enables user to match the speed to the application
- Efficient BL™ Brushless motor is electronically controlled to optimize battery energy use for up to 50% longer run time per charge
- The BL™ Brushless Motor eliminates carbon brushes, enabling the BL™ Motor to run cooler and more efficiently for longer life
- The electronically-controlled BL™ Brushless Motor efficiently uses energy to match torque and SPM to the changing demands of the application
- "Tool-less" blade change system allows for faster blade installation and removal for increased productivity

XVJ02Z Includes: Tool only, battery & charger not included 4-1/8" 9TPI Jig Saw Blade (792529-7)

Length of Stroke	1"
Max. Cutting Capacity at 90° (wood)	5-5/16"
Max. Cutting Capacity at 90° (mild steel)	3/8"
Max. Cutting Capacity at 90° (aluminum)	25/32"
Strokes Per Minute (variable speed)	800 - 3,500 SPM
Blade Shank	"T" Tang
Battery	18V LXT® Lithium-Ion
Overall Length	10-1/2"
Net Weight (with battery)	5.8 lbs.
Shipping Weight	5.3 lbs.



LXT

XVJ03

XVJ03Z

18V LXT® Jig Saw Kit

- Makita-built variable speed motor delivers 0-2,600 SPM for faster and more efficient cutting
- 3 orbital settings plus straight cutting for use in a variety of materials
- "Tool-less" blade change system allows for faster blade installation and removal for increased productivity
- Large 2-finger variable speed trigger for added convenience
- Heavy gauge, precision machined base for smooth, accurate cutting and added durability
- Built-in L.E.D. light illuminates the work area

XVJ03 Includes: 18V LXT® Jig Saw (XVJ03Z), (2) 18V LXT® Lithium-Ion 3.0Ah Battery (BL1830B), 18V LXT® Lithium-Ion Rapid Optimum Charger (DC18RC), Jig Saw Blade, T Shank, HCS, 4-1/8" x 9TPI (792729-9-1), Anti-Splintering Insert (415524-7), Cover Plate (417852-6), Tool Bag (821016-X)

XVJ03Z Includes: Tool only, battery & charger not included Cover Plate (417852-6), 4-1/8" 9TPI Jig Saw Blade (792529-7)

Length of Stroke	1"
Max. Cutting Capacity at 90° (wood)	5-5/16"
Max. Cutting Capacity at 90° (steel)	3/8"
Max. Cutting Capacity at 90° (aluminum)	25/32"
Strokes Per Minute (variable speed)	0 - 2,600 SPM
Blade Shank	"T" Tang
Battery	18V LXT® Lithium-Ion
Overall Length	10-1/8"
Net Weight (with battery)	6.4 lbs.
Shipping Weight	14.7 lbs.



LXT BRUSHLESS

XRJ06PT

XRJ06Z

18V X2 LXT® (36V) Brushless Recipro Saw Kit

- X2 LXT® technology delivers up to 155 cuts per charge in 2x10 SPF lumber using two 5.0Ah batteries
- Makita-built variable 2-speed brushless motor delivers 0-2,300 (Low) and 0-3,000 (High) strokes per minute
- Reinforced fixed shoe for added durability
- Refined crank mechanism design minimizes blade deflection and reduces vibration
- "Tool-less" blade change system allows for faster blade installation and removal for increased productivity

XRJ06PT Includes: 18V X2 LXT® (36V) Brushless Recipro Saw (XRJ06Z), (2) 18V LXT® Lithium-Ion 5.0Ah Battery (BL1850B), 18V LXT® Lithium-Ion Dual Port Charger (DC18RD), Tool Bag (831271-6), 6" Metal Cutting Recipro Saw Blade, 18TPI (723066-A-1)

XRJ06Z Includes: Tool only, battery & charger not included 6" Metal Cutting Recipro Saw Blade, 18TPI (723066-A-1)

Length of Stroke	1-1/4"
Max. Cutting Capacity (wood w/ 12" blade)	10"
Max. Cutting Capacity (pipe)	5-1/8"
Strokes Per Minute (var. 2 spd.)	0 - 2,300 / 0 - 3,000 SPM
Battery	2X 18V LXT® Lithium-Ion
Overall Length	17-3/4"
Net Weight (with battery)	10.2 lbs.
Shipping Weight	19.845 lbs.



LXT BRUSHLESS

XRJ05T

XRJ05Z

18V LXT® Brushless Recipro Saw Kit

- Makita-built variable 2-speed brushless motor delivers 0-2,300 (Low) & 0-3,000 (High) strokes per minute and a 1-1/4" stroke length for faster cutting
- "Tool-less" blade change system allows for faster blade installation and removal for increased productivity
- Large two-finger variable speed trigger for operator convenience
- Compact and ergonomic design at only 17-1/4" long
- Weighs only 8.2 lbs. with battery for reduced operator fatigue
- Rubberized soft grip handle provides increased comfort on the job

XRJ05T Includes: 18V LXT® Brushless Recipro Saw (XRJ05T), (2) 18V LXT® Lithium-Ion 5.0Ah Battery (BL1850B), 18V LXT® Lithium-Ion Rapid Optimum Charger (DC18RC), Recipro Saw Blade, Tool Case

XRJ05Z Includes: Tool only, battery & charger not included 6" 6TPI Recipro Saw Blade (723054-A-1)

Length of Stroke	1-1/4"
Max. Cutting Capacity (wood w/ 12" blade)	10"
Max. Cutting Capacity (pipe)	5-1/8"
Strokes Per Minute (var. 2 spd.)	0 - 2,300 / 0 - 3,000 SPM
Battery	18V LXT® Lithium-Ion
Overall Length	17-1/4"
Net Weight (with battery)	8.2 lbs.
Shipping Weight	19.01 lbs.



LXT

XRJ04T

XRJ04Z

18V LXT® Recipro Saw Kit

- Makita-built variable speed motor delivers 0-2,800 strokes per minute and a 1-1/4" stroke length for faster cutting
- "Tool-less" blade change system allows for faster blade installation and removal for increased productivity
- Refined crank mechanism design minimizes blade deflection and reduces vibration
- Variable speed trigger for added convenience
- Compact and ergonomic design at only 19-1/8" long
- Weighs only 8.3 lbs. with battery for reduced operator fatigue

XRJ04T Includes: 18V LXT® Recipro Saw (XRJ04T), (2) 18V LXT® Lithium-Ion 5.0Ah Battery (BL1850B), 18V LXT® Lithium-Ion Rapid Optimum Charger (DC18RC), 6" 6TPI Recipro Saw Blade (723054-A-1), Tool Case

XRJ04Z Includes: Tool only, battery & charger not included Recipro Saw Blade

Length of Stroke	1-1/4"
Max. Cutting Capacity (wood w/ 12" blade)	10"
Max. Cutting Capacity (pipe)	5-1/8"
Strokes Per Minute (variable speed)	0 - 2,800 SPM
Battery	18V LXT® Lithium-Ion
Overall Length	19-1/8"
Net Weight (with battery)	8.3 lbs.
Shipping Weight	18.63 lbs.



LXT COMPACT

XRJ01T

XRJ01Z

18V LXT® Compact Recipro Saw Kit

- Variable speed (0 - 3,000 SPM) with a 1/2" stroke length for faster and more efficient cutting
- Makita exclusive dual-position on/off switch allows for either paddle or trigger switch operation
- "Tool-less" blade change system allows for faster blade installation and removal for increased productivity
- Compact and ergonomic design at 15-5/8" long
- Weighs only 3.9 lbs. (with battery) for reduced operator fatigue
- Built-in L.E.D. light illuminates the work area

XRJ01T Includes: 18V LXT® Compact Recipro Saw (XRJ01T), (2) 18V LXT® Lithium-Ion 5.0Ah Battery (BL1850B), 18V LXT® Lithium-Ion Rapid Optimum Charger (DC18RC), 4" 18TPI Metal Cutting Recipro Saw Blade (723063-A-1), 4" 6TPI Wood Cutting Recipro Saw Blade (B-20432-1), Tool Bag

XRJ01Z Includes: Tool only, battery & charger not included 4" 18TPI Metal Cutting Recipro Saw Blade (B-20404), 4" 6TPI Wood Cutting Recipro Saw Blade (B-20432)

Length of Stroke	1/2"
Max. Cutting Capacity (wood)	2"
Max. Cutting Capacity (pipe)	2"
Strokes Per Minute (variable speed)	0 - 3,000 SPM
Battery	18V LXT® Lithium-Ion
Overall Length	15-5/8"
Net Weight (with battery)	3.9 lbs.
Shipping Weight	12.1 lbs.



LXT BRUSHLESS

XRJ07R1B

XRJ07Z

18V LXT® Sub-Compact Brushless Recipro Saw Kit

- Makita-built brushless motor delivers 0-3,000 strokes per minute combined with a 13/16" stroke length for faster and more efficient cutting
- Compact and ergonomic design at only 12-1/2" long
- Weighs only 5.7 lbs. with battery for reduced operator fatigue
- Ideal for working in tight spaces
- "Tool-less" blade change system allows for faster blade installation and removal for increased productivity
- Reinforced fixed shoe for added durability

XRJ07R1B Includes: 18V LXT® Sub-Compact Brushless Recipro Saw (XRJ07ZB), 18V LXT® Lithium-Ion Compact 2.0Ah Battery (BL1820B), 18V LXT® Lithium-Ion Rapid Optimum Charger (DC18RC), 4" Metal Cutting Recipro Saw Blade, 18TPI (B-20404), 4" 6TPI Wood Cutting Recipro Saw Blade (B-20432-1), Tool Bag

XRJ07ZB Includes: Tool only, battery & charger not included 4" 6TPI Wood Cutting Recipro Saw Blade (B-20432-1), 4" Metal Cutting Recipro Saw Blade, 18TPI (B-20404)

Length of Stroke	13/16"
Max. Cutting Capacity (wood w/ 12" blade)	10"
Max. Cutting Capacity (pipe)	5-1/8"
Strokes Per Minute (variable speed)	0 - 3,000 SPM
Battery	18V LXT® Compact Lithium-Ion
Overall Length	12-1/2"
Net Weight (with battery)	5.7 lbs.
Shipping Weight	10.1 lbs.

METALWORKING



LXT BRUSHLESS

NEW XSC04T

XSC04Z

18V LXT® BL™ 5-7/8" Metal Cutting Saw Kit, with Electric Brake and Chip Collector

- Powerful BL™ Brushless Motor Delivers up to 125 cuts per charge in 1" SCH 40 Pipe using an 18V LXT® 5.0Ah Battery
- Up to 2-1/4" cutting depth in various metal materials including thread rod, channel strut, conduit, pipe, square tubing, sheet metal and more
- The BL™ Brushless Motor eliminates carbon brushes, enabling the BL™ Motor to run cooler and more efficiently for longer life; delivers 4,200 RPM
- Transparent chip collector box captures debris produced while cutting and provides needed visibility in determining need for disposal

XSC04T Includes: 18V LXT® BL™ 5-7/8" Metal Cutting Saw, with Electric Brake and Chip Collector (XSC04Z), (2) 18V LXT® Lithium-Ion 5.0Ah Battery (BL1850B), 18V LXT® Lithium-Ion Rapid Optimum Charger (DC18RC), 5-7/8" 32T C.T. Saw Blade (A-96095), Hex Wrench (783203-8), Tool Bag (831271-6), Eye Goggles

XSC04Z Includes: Tool only, battery & charger not included 5-7/8" 32T C.T. Saw Blade (A-96095), Hex Wrench (783203-8), Eye Goggles

Blade Diameter	5-7/8"
Arbor	5/8"
Max. Cutting Depth	2-1/4"
No Load Speed	4,200 RPM
Electric Brake	Yes
Dust Collection	Yes
Battery	18V LXT® Lithium-Ion
Overall Length	10-1/2"
Net Weight (with battery)	6.8 lbs.



LXT BRUSHLESS

XSC02T

XSC02Z

18V LXT® Brushless 5-7/8" Metal Cutting Saw Kit

- Automatic Speed Change™ technology adjusts cutting speed and torque during cut for optimum performance
- Large cutting capacity (2-1/4" at 90°) allows for 2" conduit to be cut in a single pass
- BL™ Motor delivers 3,900 RPM for faster cutting
- The BL™ Brushless Motor eliminates carbon brushes, enabling the BL™ Motor to run cooler and more efficiently for longer life
- Cuts a wide range of metals including Unistrut®, all thread, channel, conduit, pipe, sheet metal, square tubing, steel and more

XSC02T Includes: 18V LXT® Brushless 5-7/8" Metal Cutting Saw (XSC02Z), (2) 18V LXT® Lithium-Ion 5.0Ah Battery (BL1850B), 18V LXT® Lithium-Ion Rapid Optimum Charger (DC18RC), 5-7/8" 32T C.T. Saw Blade (A-96095), Tool Bag (831271-6)

XSC02Z Includes: Tool only, battery & charger not included 5-7/8" 32T C.T. Saw Blade (A-96095)

Blade Diameter	5-7/8"
Arbor	5/8"
Max. Cutting Depth	2-1/4"
No Load Speed	3,900 RPM
Battery	18V LXT® Lithium-Ion
Overall Length	13-1/8"
Net Weight (with battery)	6.4 lbs.
Shipping Weight	15.2 lbs.



LXT

NEW XSC03T

XSC03Z

18V LXT® 5-3/8" Metal Cutting Saw Kit, with Electric Brake and Chip Collector

- Up to 2" cutting depth in various metal materials including thread rod, channel strut, conduit, pipe, square tubing, sheet metal and more
- Makita-built motor delivers 3,600 RPM for faster cutting using an 18V LXT® Lithium-Ion battery
- Chip collector box captures debris produced while cutting
- Transparent chip container provides needed visibility in determining when the debris need to be emptied
- Trigger switch with two stage lock-off requires two actions to power the saw

XSC03T Includes: 18V LXT® 5-3/8" Metal Cutting Saw, with Electric Brake and Chip Collector (XSC03Z), (2) 18V LXT® Lithium-Ion 5.0Ah Battery (BL1850B), 18V LXT® Lithium-Ion Rapid Optimum Charger (DC18RC), 5-3/8" 30T C.T. Saw Blade (A-95037), Hex Wrench (783203-8), Tool Bag (831271-6), Eye Goggles

XSC03Z Includes: Tool only, battery & charger not included 5-3/8" 30T C.T. Saw Blade (A-95037), Hex Wrench (783203-8), Eye Goggles

Blade Diameter	5-3/8"
Arbor	5/8"
Max. Cutting Depth	2"
No Load Speed	3,600 RPM
Electric Brake	Yes
Dust Collection	Yes
Battery	18V LXT® Lithium-Ion
Overall Length	13-3/4"
Net Weight (with battery)	6 lbs.



LXT

XSC01T

XSC01Z

18V LXT® 5-3/8" Metal Cutting Saw Kit

- Makita-built motor delivers 3,600 RPM for faster cutting
- Cuts a wide range of metals including Unistrut®, all thread, channel, conduit, pipe, sheet metal, square tubing, steel and more
- Compact and ergonomic design at 13-3/4" long
- Weighs only 5.7 lbs. with battery for reduced operator fatigue
- Rubberized soft grip handle provides increased comfort on the job
- Built-in L.E.D. light illuminates the work area

XSC01T Includes: 18V LXT® 5-3/8" Metal Cutting Saw (XSC01Z), (2) 18V LXT® Lithium-Ion 5.0Ah Battery (BL1850B), 18V LXT® Lithium-Ion Rapid Optimum Charger (DC18RC), 5-3/8" 30T C.T. Saw Blade (A-95037), Tool Case

XSC01Z Includes: Tool only, battery & charger not included 5-3/8" 30T C.T. Saw Blade (A-95037)

Blade Diameter	5-3/8"
Arbor	5/8"
Max. Cutting Depth	2"
No Load Speed	3,600 RPM
Battery	18V LXT® Lithium-Ion
Overall Length	13-3/4"
Net Weight (with battery)	5.7 lbs.
Shipping Weight	16 lbs.



LXT

XBP02TX

XBP02Z

18V LXT® Portable Band Saw Kit

- 4-3/4" cutting capacity accepts a 44-7/8" blade and is ideal for cutting multiple metal materials
- Makita-built motor delivers faster cutting with variable speed 275-530 ft./min.
- Trigger switch with lock-off feature requires two actions to power on the band saw
- Conveniently located variable speed control dial enables user to match the speed to the application
- Protection circuit with built-in alert light provides over-torque motor protection warning
- Built-in L.E.D. light illuminates the work area for increased visibility

XBP02TX Includes: 18V LXT® Portable Band Saw (XBP02Z), (2) 18V LXT® Lithium-Ion 5.0Ah Battery (BL1850B), 18V LXT® Lithium-Ion Rapid Optimum Charger (DC18RC), 44-7/8" 18TPI Band Saw Blade (792556-A), Tool Bag (831263-5)

XBP02Z Includes: Tool only, battery & charger not included
44-7/8" 18TPI Band Saw Blade (792556-A)

Max. Cutting Capacity (round workpiece)	4-3/4"
Max. Cutting Capacity (rectangular workpiece)	4-3/4" x 4-3/4"
No Load Speed (ft./min., var. speed)	275 - 530 ft./min.
Blade Length	44-7/8"
Battery	18V LXT® Lithium-Ion
Overall Length	20-5/8"
Net Weight (with battery)	14.3 lbs.
Shipping Weight	27.12 lbs.



LXT COMPACT

XBP03T

XBP03Z

18V LXT® Compact Band Saw Kit

- 2-1/2" cutting capacity is ideal for cutting conduit, Unistrut®, copper pipe, threaded rod, angle iron and channel
- Makita-built motor delivers 630 ft./min. blade speed for faster cutting
- Wheel cover encloses the blade outside the cutting area making the saw suitable for one-handed operation
- Aluminum blade housing for increased durability
- Exterior blade adjustment provides more accurate blade tracking for increased cutting performance
- Compact design at 18-3/4" long, weighs only 9 lbs. (with battery) for convenient operation

XBP03T Includes: 18V LXT® Compact Band Saw (XBP03Z), (2) 18V LXT® Lithium-Ion 5.0Ah Battery (BL1850B), 18V LXT® Lithium-Ion Rapid Optimum Charger (DC18RC), Band Saw Blade, Hex Wrench, Tool Bag,

XBP03Z Includes: Tool only, battery & charger not included
Band Saw Blade

Max. Cutting Capacity (round workpiece)	2-1/2"
Max. Cutting Capacity (rectangular workpiece)	2-1/2" x 2-1/2"
No Load Speed (ft./min.)	630 ft./min.
Blade Length	32-7/8"
Battery	18V LXT® Lithium-Ion
Overall Length	18-3/4"
Net Weight (with battery)	9 lbs.
Built-in light	Yes



LXT

XDG01T

XDG01Z

18V LXT® 1/4" Die Grinder Kit

- Compact barrel grip design and weighs only 4.4 lbs. for easy handling
- Slide switch with lock-on for operator convenience
- Vent slots designed to direct exhaust air away from the user
- L.E.D. light flashes red when it is time to recharge the battery
- Built-in L.E.D. protection circuit with over-torque control protects the motor
- Solid aluminum housing for added durability

XDG01T Includes: 18V LXT® 1/4" Die Grinder (XDG01Z), (2) 18V LXT® Lithium-Ion 5.0Ah Battery (BL1850B), 18V LXT® Lithium-Ion Rapid Optimum Charger (DC18RC), 1/4" Collet (763625-6), (2) Spanner Wrench (781039-9), Tool Bag (821016-X)

XDG01Z Includes: Tool only, battery & charger not included
1/4" Collet (763625-6), (2) Spanner Wrench (781039-9)

Max. Wheel Diameter	1-1/2"
Battery	18V LXT® Lithium-Ion
Collet	1/4"
No Load Speed	25,000 RPM
Lock-On Switch	Yes
Lock-Off Switch	No
Overall Length	15-3/4"
Net Weight (with battery)	4.4 lbs.
Shipping Weight	12.6 lbs.



LXT

XDG02Z

18V LXT® 1/4" Compact Die Grinder

- Makita-built 4-pole motor delivers 26,000 revolutions per minute for faster grinding
- Short neck design is only 12-1/8" long with battery (not included) for increased maneuverability
- Compact barrel grip design with rubberized soft grip allows for easy grinding in various orientations
- Vent slots designed to direct exhaust air away from the user
- Built-in alert light provides overload motor protection warning and low battery recharge warning for operator convenience
- Anti-restart protection designed to prevent motor start up when battery is inserted with switch locked on

XDG02Z Includes: Tool only, battery & charger not included
1/4" Collet (763673-7), Collet Nut (763668-0), Spanner Wrench (781039-9)

Max. Wheel Diameter	1-1/2"
Battery	18V LXT® Lithium-Ion
Collet	1/4"
No Load Speed	26,000 RPM
Lock-On Switch	Yes
Lock-Off Switch	No
Overall Length	12-1/8"
Net Weight (with battery)	3.8 lbs.
Shipping Weight	3.31 lbs.



LXT BRUSHLESS

XWL01PT

XWL01Z

18V X2 LXT® (36V) Brushless 14" Cut-Off Saw Kit

- Two 18V LXT® Lithium-Ion batteries deliver the power and run time for corded demands without leaving the 18V LXT® platform
- The BL™ Brushless Motor eliminates carbon brushes, enabling the BL™ Motor to run cooler and more efficiently for longer life; delivers 3,800 RPM
- Large spark guard captures and deflects debris away from the surrounding area
- Electric brake allows adjustments to be completed faster for maximum productivity
- "Tool-less" flange removal for quick and easy wheel changes

XWL01PT Includes: 18V X2 LXT® (36V) Brushless 14" Cut-Off Saw (XWL01Z), (2) 18V LXT® Lithium-Ion 5.0Ah Battery (BL1850B), 18V LXT® Lithium-Ion Dual Port Charger (DC18RD), 14" x 1" x 3/32" Abrasive Cut-Off Wheel (B-64705-1)

XWL01Z Includes: Tool only, battery & charger not included
14" x 1" x 3/32" Abrasive Cut-Off Wheel (B-64705-1)

Battery	2X 18V LXT® Lithium-Ion
Blade Diameter	14"
No Load Speed	3,800 RPM
Max. Cutting Capacity (at 90°)	5"
Arbor	1"
Tool-less blade change	Yes
Tool-less fence adjustment	Yes
Lock-Off Switch	Yes
Electric Brake	Yes
Overall Length	21-1/8"
Net Weight	35.9 lbs.
Shipping Weight	49.46 lbs.



LXT BRUSHLESS

XAG23ZU1

18V X2 LXT® (36V) Brushless 9" Angle Grinder, AWS™

- The BL™ Brushless Motor eliminates carbon brushes, enabling the BL™ Motor to run cooler and more efficiently for longer life; delivers 6,000 RPM
- Two 18V LXT® Lithium-Ion batteries deliver corded power without leaving the 18V LXT® battery platform (batteries not included)
- Active Feedback-sensing Technology (AFT™) turns the motor off if rotation of the wheel is suddenly forced to stop
- Electric brake stops the grinding or cut-off wheel in 4.5 seconds or less for maximum productivity
- Auto-start Wireless System (AWS™) utilizes Bluetooth® technology for wireless power-on/off communication between tool and dust extractor

XAG23ZU1 Includes: Tool only, battery & charger not included
9" Tool-less Wheel Guard (123543-6), 9" Cut-Off Wheel Guard (122913-6), 9" x 1/4" x 7/8" INOX Grinding Wheel, 36 Grit (A-96051), 9" x 0.75" x 7/8" INOX Thin Cut-Off Wheel, 60 Grit (B-12675), Side Handle (143486-6), Lock Nut Wrench (782412-6), Auto-Start Wireless Transmitter (198901-5)

Wheel Diameter	9"
Battery	2X 18V LXT® Lithium-Ion
No Load Speed	6,000 RPM
Spindle Thread	5/8" - 11 UNC
Lock-On Switch	No
Lock-Off Switch	Yes
Switch Type	Rear trigger handle
Electrical Brake	Yes
Variable speed control dial	No
Automatic-start Wireless System (AWS™)	Yes (Transmitter Included)
Overall Length	19-5/8"
Net Weight (with battery)	13.01 lbs.
Shipping Weight	19.11 lbs.



LXT BRUSHLESS

XAG13PT1

XAG13Z1

18V X2 LXT® (36V) Brushless 9" Cut-Off/Angle Grinder Kit

- Two 18V LXT® Lithium-Ion batteries deliver corded power without leaving the 18V LXT® battery platform
- Electric brake stops the grinding or cut-off wheel in 4.5 seconds or less for maximum productivity
- Active Feedback-sensing Technology (AFT™) turns the motor off if rotation of the wheel is suddenly forced to stop

XAG13PT1 Includes: 18V X2 LXT® (36V) Brushless 9" Cut-Off/Angle Grinder (XAG13Z1), (2) 18V LXT® Lithium-Ion 5.0Ah Battery (BL1850B), 18V LXT® Lithium-Ion Dual Port Charger (DC18RD), 9" Tool-less Wheel Guard (123543-6), 9" Cut-Off Wheel Guard (122913-6), 9" x 1/4" x 7/8" INOX Grinding Wheel, 36 Grit (A-96051), 9" x 0.75" x 7/8" INOX Thin Cut-Off Wheel, 60 Grit (B-12675), Side Handle (143486-6), 23" Contractor Tool Bag (831284-7), Lock Nut Wrench (782412-6)

XAG13Z1 Includes: Tool only, battery & charger not included
9" Tool-less Wheel Guard (123543-6), 9" Cut-Off Wheel Guard (122913-6), 9" x 1/4" x 7/8" INOX Grinding Wheel, 36 Grit (A-96051), 9" x 0.75" x 7/8" INOX Thin Cut-Off Wheel, 60 Grit (B-12675), Side Handle (143486-6), Lock Nut Wrench (782412-6)

Wheel Diameter	9"
Battery	2X 18V LXT® Lithium-Ion
No Load Speed	6,000 RPM
Spindle Thread	5/8" - 11 UNC
Lock-On Switch	No
Lock-Off Switch	Yes
Switch Type	Rear trigger handle
Electrical Brake	Yes
Variable speed control dial	No
Automatic-start Wireless System (AWS™)	No
Overall Length	19-5/8"
Net Weight (with battery)	13.01 lbs.
Shipping Weight	29.8 lbs.



LXT BRUSHLESS

XAG22ZU1

18V X2 LXT® (36V) Brushless 7" Angle Grinder, AWS™

- The BL™ Brushless Motor eliminates carbon brushes, enabling the BL™ Motor to run cooler and more efficiently for longer life; delivers 7,800 RPM
- Two 18V LXT® Lithium-Ion batteries deliver corded power without leaving the 18V LXT® battery platform (batteries not included)
- Active Feedback-sensing Technology (AFT™) turns the motor off if rotation of the wheel is suddenly forced to stop
- Electric brake stops the grinding or cut-off wheel in 4.5 seconds or less for maximum productivity
- Auto-start Wireless System (AWS™) utilizes Bluetooth® technology for wireless power-on/off communication between tool and dust extractor

XAG22ZU1 Includes: Tool only, battery & charger not included
7" Tool-less Wheel Guard (123542-6), 7" Cut-Off Wheel Guard (122914-4), 7" x 1/4" x 7/8" INOX Grinding Wheel, 36 Grit (A-96045), 7" x 1/16" x 7/8" INOX Thin Cut-Off Wheel, 60 Grit (B-12669), Side Handle (143486-6), Lock Nut Wrench (782412-6), Auto-Start Wireless Transmitter (198901-5)

Wheel Diameter	7"
No Load Speed	7,800 RPM
Spindle Thread	5/8" - 11 UNC
Lock-On Switch	No
Lock-Off Switch	Yes
Max. Cutting Depth	1-7/8"
Switch Type	Rear trigger handle
Electric Brake	Yes
Variable speed control dial	No
Automatic-start Wireless System (AWS™)	Yes (Transmitter Included)
Battery	2X 18V LXT® Lithium-Ion
Overall Length	19-5/8"
Net Weight (with battery)	11.4 lbs.
Shipping Weight	14.9 lbs.



LXT BRUSHLESS **XAG12PT1**

- 18V X2 LXT® (36V) Brushless 7" Cut-Off/Angle Grinder Kit**
- Two 18V LXT® Lithium-Ion batteries deliver corded power without leaving the 18V LXT® battery platform
 - Electric brake stops the grinding or cut-off wheel in 4.5 seconds or less for maximum productivity
 - Active Feedback-sensing Technology (AFT™) turns the motor off if rotation of the wheel is suddenly forced to stop

XAG12PT1 Includes: 18V X2 LXT® (36V) Brushless 7" Cut-Off/Angle Grinder (XAG1221), (2) 18V LXT® Lithium-Ion 5.0Ah Battery (BL1850B), 18V LXT® Lithium-Ion Dual Port Charger (DC18RD), 7" Tool-less Wheel Guard (123542-8), 7" Cut-Off Wheel Guard (122914-4), 7" x 1/4" x 7/8" INOX Grinding Wheel, 36 Grit (A-96045), 7" x 1/16" x 7/8" INOX Thin Cut-Off Wheel, 60 Grit (B-12669), Side Handle (143486-6), 23" Contractor Tool Bag (831284-1), Lock Nut Wrench (782412-6)

XAG1221 Includes: Tool only, battery & charger not included 7" Tool-less Wheel Guard (123542-8), 7" Cut-Off Wheel Guard (122914-4), Side Handle (143486-6), 7" x 1/4" x 7/8" INOX Grinding Wheel, 36 Grit (A-96045), 7" x 1/16" x 7/8" INOX Thin Cut-Off Wheel, 60 Grit (B-12669), Lock Nut Wrench (782412-6)

Wheel Diameter	7"
Battery	2X 18V LXT® Lithium-Ion
No Load Speed	7,800 RPM
Spindle Thread	5/8" - 11 UNC
Lock-On Switch	No
Lock-Off Switch	Yes
Switch Type	Rear trigger handle
Electric Brake	Yes
Variable speed control dial	No
Automatic-start Wireless System (AWS™)	No
Overall Length	19-5/8"
Net Weight (with battery)	11.4 lbs.
Shipping Weight	29.76 lbs.



LXT BRUSHLESS **XAG21ZU**

- 18V LXT® Brushless 4-1/2" / 5" Paddle Switch Cut-Off/Angle Grinder, AWS™**
- Electric Brake stops the grinding or cut-off wheel in 2 seconds or less for maximum productivity
 - Active Feedback-sensing Technology (AFT™) turns the motor off if rotation of the wheel is suddenly forced to stop
 - Automatic-start Wireless System (AWS™) utilizes Bluetooth® technology for wireless power-on/off communication between tool and dust extractor
 - Automatic Speed Change™ technology adjusts speed and torque during operation for optimum performance
 - The BL™ Brushless Motor eliminates carbon brushes, enabling the BL™ Motor to run cooler and more efficiently for longer life

XAG21ZU Includes: Tool only, battery & charger not included 5" x 1/4" x 7/8" INOX Grinding Wheel, 36 Grit (A-95962), 5" Cut-Off Wheel Guard (126686-3), 5" Tool-less Wheel Guard (126687-1), Lock Nut Wrench (782424-9), Auto-Start Wireless Transmitter (198901-5), Side Handle (158237-4)

Wheel Diameter	5"
Battery	18V LXT® Lithium-Ion
No Load Speed (variable speed)	3,000 - 8,500 RPM
Spindle Thread	5/8" - 11 UNC
Lock-On Switch	No
Lock-Off Switch	Yes
Switch Type	Body grip/paddle
Electric Brake	Yes
Variable speed control dial	Yes
Automatic-start Wireless System (AWS™)	Yes (Transmitter Included)
Overall Length	15"
Net Weight (with battery)	5.7 lbs.
Shipping Weight	7.6 lbs.



LXT BRUSHLESS **XAG17ZU**

- 18V LXT® Brushless 4-1/2" / 5" Cut-Off/Angle Grinder, AWS™**
- Electric Brake stops the grinding or cut-off wheel in 2 seconds or less for maximum productivity
 - Active Feedback-sensing Technology (AFT™) turns the motor off if rotation of the wheel is suddenly forced to stop
 - Automatic Speed Change™ technology adjusts speed and torque during operation for optimum performance
 - Automatic-start Wireless System (AWS™) utilizes Bluetooth® technology for wireless power-on/off communication between tool and dust extractor
 - The BL™ Brushless Motor eliminates carbon brushes, enabling the BL™ Motor to run cooler and more efficiently for longer life

XAG17ZU Includes: Tool only, battery & charger not included 5" x 1/4" x 7/8" INOX Grinding Wheel, 36 Grit (A-95962), 5" Cut-Off Wheel Guard (126686-3), 5" Tool-less Wheel Guard (126687-1), Lock Nut Wrench (782424-9), Auto-Start Wireless Transmitter (198901-5), Side Handle (158237-4)

Wheel Diameter	5"
Battery	18V LXT® Lithium-Ion
No Load Speed (variable speed)	3,000 - 8,500 RPM
Spindle Thread	5/8" - 11 UNC
Lock-On Switch	Yes
Lock-Off Switch	No
Switch Type	Body grip/slide
Electric Brake	Yes
Variable speed control dial	Yes
Automatic-start Wireless System (AWS™)	Yes (Transmitter Included)
Overall Length	15"
Net Weight (with battery)	5.7 lbs.
Shipping Weight	7.5 lbs.



LXT BRUSHLESS **XAG20Z**

- 18V LXT® Brushless 4-1/2" / 5" Paddle Switch Cut-Off/Angle Grinder**
- Electric Brake stops the grinding or cut-off wheel in 2 seconds or less for maximum productivity
 - Active Feedback-sensing Technology (AFT™) turns the motor off if rotation of the wheel is suddenly forced to stop
 - Automatic Speed Change™ technology adjusts speed and torque during operation for optimum performance
 - The BL™ Brushless Motor eliminates carbon brushes, enabling the BL™ Motor to run cooler and more efficiently for longer life
 - Variable speed control dial allows manual RPM adjustment (3,000-8,500) to match the speed to the application
 - Soft start suppresses start-up reaction for smooth start-ups and longer gear life

XAG20Z Includes: Tool only, battery & charger not included 5" x 1/4" x 7/8" INOX Grinding Wheel, 36 Grit (A-95962), 5" Cut-Off Wheel Guard (126686-3), 5" Tool-less Wheel Guard (126687-1), Lock Nut Wrench (782424-9), Side Handle (158237-4)

Wheel Diameter	5"
Battery	18V LXT® Lithium-Ion
No Load Speed (variable speed)	3,000 - 8,500 RPM
Spindle Thread	5/8" - 11 UNC
Lock-On Switch	No
Lock-Off Switch	Yes
Switch Type	Body grip/paddle
Electric Brake	Yes
Variable speed control dial	Yes
Overall Length	15"
Net Weight (with battery)	5.7 lbs.
Shipping Weight	7.6 lbs.



LXT BRUSHLESS **XAG16Z**

- 18V LXT® Brushless 4-1/2" / 5" Cut-Off/Angle Grinder**
- Electric Brake stops the grinding or cut-off wheel in 2 seconds or less for maximum productivity
 - Active Feedback-sensing Technology (AFT™) turns the motor off if rotation of the wheel is suddenly forced to stop
 - Automatic Speed Change™ technology adjusts speed and torque during operation for optimum performance
 - The BL™ Brushless Motor eliminates carbon brushes, enabling the BL™ Motor to run cooler and more efficiently for longer life
 - Variable speed control dial allows manual RPM adjustment (3,000-8,500) to match the speed to the application
 - Soft start suppresses start-up reaction for smooth start-ups and longer gear life

XAG16Z Includes: Tool only, battery & charger not included 5" x 1/4" x 7/8" INOX Grinding Wheel, 36 Grit (A-95962), 5" Cut-Off Wheel Guard (126686-3), 5" Tool-less Wheel Guard (126687-1), Lock Nut Wrench (782424-9), Side Handle (158237-4)

Wheel Diameter	5"
Battery	18V LXT® Lithium-Ion
No Load Speed (variable speed)	3,000 - 8,500 RPM
Spindle Thread	5/8" - 11 UNC
Lock-On Switch	Yes
Lock-Off Switch	No
Switch Type	Body grip/slide
Electric Brake	Yes
Variable speed control dial	Yes
Overall Length	15"
Net Weight (with battery)	5.7 lbs.
Shipping Weight	7.4 lbs.



LXT BRUSHLESS **XAG11T**

- 18V LXT® Brushless 4-1/2" / 5" Cut-Off/Angle Grinder Kit**
- Electric brake stops the grinding or cut-off wheel in 2 seconds or less for maximum productivity
 - Active Feedback-sensing Technology (AFT™) turns the motor off if rotation of the wheel is suddenly forced to stop
 - Automatic Speed Change™ technology adjusts speed and torque during operation for optimum performance

XAG11T Includes: 18V LXT® Brushless 4-1/2" / 5" Cut-Off/Angle Grinder (XAG11Z), (2) 18V LXT® Lithium-Ion 5.0Ah Battery (BL1850B), 5" Cut-Off Wheel Guard (126686-3), 5" Tool-less Wheel Guard (126687-1), 18V LXT® Lithium-Ion Rapid Optimum Charger (DC18RC), 5" x 1/4" x 7/8" INOX Grinding Wheel, 36 Grit (A-95962), 5" Ultra Thin Cut-Off Wheel, Stainless (B-46165), 14" Contractor Tool Bag (831253-8), Side Handle

Wheel Diameter	5"
Battery	18V LXT® Lithium-Ion
No Load Speed	8,500 RPM
Spindle Thread	5/8" - 11 UNC
Lock-On Switch	No
Lock-Off Switch	Yes
Switch Type	Body grip/paddle
Electric Brake	Yes
Variable speed control dial	No
Overall Length	14-1/4"
Net Weight (with battery)	5.8 lbs.
Shipping Weight	15 lbs.



LXT BRUSHLESS **XAG09Z**

- 18V LXT® Brushless 4-1/2" / 5" Cut-Off/Angle Grinder**
- Electric brake stops the grinding or cut-off wheel in 2 seconds or less for maximum productivity
 - Active Feedback-sensing Technology (AFT™) turns the motor off if rotation of the wheel is suddenly forced to stop
 - Automatic Speed Change™ technology adjusts speed and torque during operation for optimum performance
 - The BL™ Brushless Motor eliminates carbon brushes, enabling the BL™ Motor to run cooler and more efficiently for longer life
 - Efficient BL™ Brushless motor is electronically controlled to optimize battery energy use for up to 50% longer run time per charge

XAG09Z Includes: Tool only, battery & charger not included 5" x 1/4" x 7/8" INOX Grinding Wheel, 36 Grit (A-95962), 5" Ultra Thin Cut-Off Wheel, Stainless (B-46165), Side Handle (158237-4), Lock Nut Wrench (782424-9), 5" Cut-Off Wheel Guard (126686-3), 5" Tool-less Wheel Guard (126687-1)

Wheel Diameter	5"
Battery	18V LXT® Lithium-Ion
No Load Speed	8,500 RPM
Spindle Thread	5/8" - 11 UNC
Lock-On Switch	Yes
Lock-Off Switch	No
Switch Type	Body grip/slide
Overall Length	14-1/4"
Net Weight (with battery)	5.7 lbs.
Shipping Weight	8 lbs.



LXT BRUSHLESS **XAG04T**

- 18V LXT® Brushless 4-1/2" / 5" Cut-Off/Angle Grinder Kit**
- Automatic Speed Change™ technology adjusts speed and torque during operation for optimum performance
 - Active Feedback-sensing Technology (AFT™) turns the motor off if rotation of the wheel is suddenly forced to stop
 - The BL™ Brushless Motor eliminates carbon brushes, enabling the BL™ Motor to run cooler and more efficiently for longer life

XAG04T Includes: 18V LXT® Brushless 4-1/2" / 5" Cut-Off/Angle Grinder (XAG04Z), (2) 18V LXT® Lithium-Ion 5.0Ah Battery (BL1850B), 18V LXT® Lithium-Ion Rapid Optimum Charger (DC18RC), 5" x 1/4" x 7/8" INOX Grinding Wheel, 36 Grit (A-95962), 5" Ultra Thin Cut-Off Wheel, Stainless (B-46165), 5" Cut-Off Wheel Guard (126686-3), 5" Tool-less Wheel Guard (126687-1), Side Handle, Tool Bag

Wheel Diameter	5"
Battery	18V LXT® Lithium-Ion
No Load Speed	8,500 RPM
Spindle Thread	5/8" - 11 UNC
Lock-On Switch	Yes
Lock-Off Switch	No
Switch Type	Body grip/slide
Overall Length	14-1/4"
Net Weight (with battery)	5.8 lbs.
Shipping Weight	15.5 lbs.



LXT

XNJO1T

XNJO1Z

18V LXT® 16 Gauge Nibbler Kit

- Makita-built motor delivers 1,900 SPM for faster and smooth cutting
- Ideal for cutting roofing sheet metal at thicknesses up to 16 gauge
- Die holder rotates 360° to meet demands of cutting direction
- Convenient chip disposal is below cutting material to minimize damage to cutting surface
- Cutting radius: inner edge 1-3/4"; outer edge 2"
- Battery capacity warning system turns light solid red and automatically stops motor to notify user that battery needs to be replaced

XNJO1T Includes: 18V LXT® 16 Gauge Nibbler (XNJO1Z), (2) 18V LXT® Lithium-Ion 5.0Ah Battery (BL1850B), 18V LXT® Lithium-Ion Rapid Optimum Charger (DC18RC), Punch (A-83951), Spanner Wrench (781028-4), Tool Bag

XNJO1Z Includes: Tool only, battery & charger not included Punch (A-83951), Spanner Wrench (781028-4)

Capacity (aluminum, ga.)	12 ga.
Capacity (mild steel, ga.)	16 ga.
Capacity (stainless, ga.)	18 ga.
Cutting Radius (inner edge)	1-3/4"
Cutting Radius (outer edge)	2"
Strokes Per Minute (variable speed)	0 - 1,900 SPM
Battery	18V LXT® Lithium-Ion
Overall Length	12-3/8"
Net Weight (with battery)	4.8 lbs.
Shipping Weight	12.57 lbs.



LXT

XSJO2Z

18V LXT® 16 Gauge Compact Straight Shear

- Cuts up to 16 ga. mild steel, 18 ga. stainless steel and easily cuts through 22 ga. spiral duct seams
- Makita-built 4-pole motor delivers 4,300 strokes per minute for faster cutting
- Compact barrel grip design with rubberized soft grip enables one-handed operation in various orientations
- High performance double blade design minimizes material distortion and produces clean cuts with minimal burrs
- Radius cutting capability allows for easy turns and circular cutting applications
- Built-in alert light provides overload motor protection warning and low battery recharge warning for operator convenience

XSJO2Z Includes: Tool only, battery & charger not included Center Blade (792534-4), Side Blade Set (792533-6), Hex Wrench (783201-2), (762013-6)

Capacity (mild steel, ga.)	16 ga.
Capacity (stainless, ga.)	18 ga.
Strokes Per Minute	4,300 SPM
Battery	18V LXT® Lithium-Ion
360° Rotating Head	No
Overall Length	14-1/4"
Net Weight	4.4 lbs.
Shipping Weight	3.97 lbs.



LXT

XSJO1T

XSJO1Z

18V LXT® 18 Gauge Straight Shear Kit

- Makita-built 4-pole motor delivers 3,000 strokes per minute for faster cutting
- Cuts up to 18 gauge mild steel and 20 gauge stainless steel
- Compact and ergonomic design at only 13-3/4" long
- Weighs only 5.3 lbs. with battery for reduced operator fatigue
- Reversible belt-clip attaches to either side of the tool
- Rubberized soft grip handle provides increased comfort on the job

XSJO1T Includes: 18V LXT® 18 Gauge Straight Shear (XSJO1Z), (2) 18V LXT® Lithium-Ion 5.0Ah Battery (BL1850B), 18V LXT® Lithium-Ion Rapid Optimum Charger (DC18RC), Tool Bag

XSJO1Z Includes: Tool only, battery & charger not included

Capacity (mild steel, ga.)	18 ga.
Capacity (stainless, ga.)	20 ga.
Strokes Per Minute	3,000 SPM
Battery	18V LXT® Lithium-Ion
360° Rotating Head	Yes
Overall Length	13-3/4"
Net Weight (with battery)	5.3 lbs.
Shipping Weight	13.6 lbs.



LXT BRUSHLESS

XCS03Z

18V LXT® Brushless Threaded Rod Cutter

- Spark-free cutting for clean, burr-free cuts allowing for easy threading
- Performs up to 1,300 cuts of 3/8" mild steel threaded rod and 1,200 cuts of 3/8" stainless steel threaded rod with one 18V LXT 5.0Ah Battery
- Ideal for overhead cutting of installed threaded rod including 1/4" and 3/8" course thread diameter sizes
- Ergonomically designed handle provides a more comfortable hand position for increased comfort and less fatigue
- Compact and ergonomic design at only 7-7/8" long and weighs only 7 lbs. with battery (battery not included)
- Automatic blade stop mechanism returns blade to open position once cut is complete to continue operation

XCS03Z Includes: Tool only, battery & charger not included

Blade Configuration	Double sided
Max. Cutting Capacity	3/8"
Min. Cutting Capacity	1/4"
Battery	18V LXT® Lithium-Ion
Overall Length	7-7/8"
Net Weight (with battery)	7 lbs.
Shipping Weight	7.06 lbs.

WOODWORKING

LARGE CUTTING CAPACITY

LXT BRUSHLESS



CAPACITY

Cuts up to 6-5/8" crown (nested), 5-1/4" base (vertical), and crosscuts a 4x12 at 90°



PRODUCTIVITY

X2 LXT® technology delivers up to 334 cuts per charge in 2x4 SPF lumber using two 5.0Ah batteries



TECHNOLOGY

Auto-Start Wireless System (AWS™) for wireless on/off between the tool and optional dust extractor



XSL04PTU

18V X2 LXT® (36V) Brushless 10" Dual-Bevel Sliding Compound Miter Saw Kit, AWS™

- Auto-Start Wireless System (AWS™) utilizes Bluetooth® technology for wireless power-on/off communication between tool and optional dust extractor
- X2 LXT® technology delivers up to 334 cuts in 2x4 SPF and 192 cuts in 2x12 SPF lumber per charge using two 5.0Ah batteries
- Unique 2-Steel Rail Sliding System allows operation flush against a wall
- In-front bevel lock for convenient operation
- Increased capacity for up to 6-5/8" crown molding (vertically nested), 5-1/4" baseboard (vertical), and 12" crosscuts at 90°
- Dual dust collection ports provide excellent dust extraction performance
- Miters 0-60° left and right; bevels 0-48° left and right

XSL04PTU Includes: 18V X2 LXT® (36V) Brushless 10" Dual-Bevel Sliding Compound Miter Saw, AWS™ (XSL04ZU), (2) 18V LXT® Lithium-Ion 5.0Ah Battery (BL1850B), 18V LXT® Lithium-Ion Dual Port Charger (DC18RD), Auto-Start Wireless Transmitter (198901-5), Vertical Vise (122854-6), Dust Bag (122852-0), Triangular Rule (762001-3), Hex Wrench, 10" x 5/8" 40T Micro-Polished Miter Saw Blade

XSL04ZU Includes: Tool only, battery & charger not included Vertical Vise (122854-6), Dust Bag (122852-0), Triangular Rule (762001-3), Hex Wrench, 10" x 5/8" 40T Micro-Polished Miter Saw Blade, Wireless Unit

Blade Diameter	10"
Arbor	5/8"
Max. Cutting Capacity (miter 90°)	2-13/16" x 12"
Max. Cutting Capacity (miter 45°, L/R)	2-13/16" x 8-1/2"
No Load Speed	4,400 RPM
Battery	2X 18V LXT® Lithium-Ion
Dimensions (LxWxH)	31-3/4" x 25-3/8" x 26"
Net Weight (with battery)	60.2 lbs.
Automatic-start Wireless System (AWS™)	Yes (Transmitter Included)
Shipping Weight	86 lbs.



XSL06PT

XSL06Z

18V X2 LXT® (36V) Brushless 10" Dual-Bevel Sliding Compound Miter Saw Kit

- X2 LXT® technology delivers up to 334 cuts per charge in 2x4 SPF and up to 192 cuts per charge in 2x12 SPF lumber using two 5.0Ah batteries
- Unique 2-Steel Rail Sliding System design allows operation flush against a wall
- In-front bevel lock for convenient operation
- Increased capacity for up to 6-5/8" crown molding (vertically nested), 5-1/4" baseboard (vertical), and 12" crosscuts at 90°

XSL06PT Includes: 18V X2 LXT® (36V) Brushless 10" Dual-Bevel Sliding Compound Miter Saw (XSL06Z), (2) 18V LXT® Lithium-Ion 5.0Ah Battery (BL1850B), 18V LXT® Lithium-Ion Dual Port Charger (DC18RD), Vertical Vise (122854-6), Dust Bag (122852-0), Triangular Rule (762001-3), Hex Wrench, XSL06 (781044-6), 10" x 5/8" 40T Micro-Polished Miter Saw Blade

XSL06Z Includes: Tool only, battery & charger not included Vertical Vise (122854-6), Dust Bag (122852-0), Triangular Rule (762001-3), Hex Wrench, 10" x 5/8" 40T Micro-Polished Miter Saw Blade

Blade Diameter	10"
Arbor	5/8"
Max. Cutting Capacity (miter 90°)	2-13/16" x 12"
Max. Cutting Capacity (miter 45°, L/R)	2-13/16" x 8-1/2"
No Load Speed	4,400 RPM
Battery	2X 18V LXT® Lithium-Ion
Dimensions (LxWxH)	31-3/4" x 25-3/8" x 26"
Net Weight (with battery)	60.2 lbs.
Shipping Weight	80.483 lbs.



LXT BRUSHLESS AUTOMATIC SPEED CHANGE
XSL02Z

18V X2 LXT® (36V) Brushless 7-1/2" Dual Slide Compound Miter Saw

- Weighs only 28.2 lbs. with battery (battery not included) for easy portability
- The electronically-controlled BL™ Brushless Motor efficiently uses energy to match torque and RPM to the changing demands of the application
- Soft start suppresses start-up reaction for smooth start-ups and longer gear life
- Miters 0-47° left and 0-57° right; bevels 0-45° left and 0-5° right
- Positive miter stops at: 0°, 15°, 22.5°, 30° and 45° left and right
- Linear ball bearing system engineered to deliver "dead-on" accurate cuts

XSL02Z Includes: Tool only, battery & charger not included 7-1/2" 40T Carbide-Tipped Miter Saw Blade (A-90629), Dust Bag (122852-0), Vertical Vise (122571-8), (2) Extension Wing (322312-4)

Blade Diameter	7-1/2"
Arbor	5/8"
Max. Cutting Capacity (miter 90°)	2-1/16" x 11-3/4"
Max. Cutting Capacity (miter 45°, L/R)	2-1/16" x 8-3/8"
No Load Speed	5,700 RPM
Battery	2X 18V LXT® Lithium-Ion
Dimensions (LxWxH)	25-3/4" x 17" x 17-1/2"
Net Weight (with battery)	28.9 lbs.
Shipping Weight	38 lbs.



LXT BRUSHLESS AUTOMATIC SPEED CHANGE
XSL05Z

18V LXT® Brushless 6-1/2" Compact Dual-Bevel Compound Miter Saw

- Weighs only 14.6 lbs. with battery (battery not included) for easy portability
- 18V LXT® Lithium-Ion Battery delivers the power and performance of a corded miter saw without leaving the 18V LXT® platform (battery not included)
- High power provides efficient cutting in wood and aluminum extrusion (aluminum blade and cutting lubricant sold separately)
- LXT® technology delivers up to 270 cuts per charge in 1/2" x 3-1/2" baseboard using one 6.0Ah battery (battery not included)
- Automatic Speed Change™ technology adjusts cutting speed and torque during cut for optimum performance

XSL05Z Includes: Tool only, battery & charger not included Triangular Rule (762001-3), Dust Bag (122852-0), 6-1/2" x 5/8" 64T Micro-Polished Miter Saw Blade, Vertical Vise, Hex Wrench

Blade Diameter	6-1/2"
Arbor	5/8"
Max. Cutting Capacity (miter 90°)	1-13/16" x 3-5/8"
Max. Cutting Capacity (miter 45°, L/R)	1-13/16" x 2-9/16"
No Load Speed	5,000 RPM
Battery	18V LXT® Lithium-Ion
Dimensions (LxWxH)	13-3/8" x 15-3/4" x 17-1/4"
Net Weight (with battery)	14.6 lbs.
Shipping Weight	20.3 lbs.



LXT
XMT035 XMT03Z

18V LXT® Multi-Tool Kit

- 18V LXT® Lithium-Ion battery provides up to 20 minutes of continuous run time
- Variable speed control dial (6,000-20,000 OPM) enables user to match the speed to the application
- 3.2° oscillation angle engineered for faster, more aggressive cutting and sanding
- Large on/off slide switch with lock-on button for operator convenience
- Includes adapters to fit most competitive accessories
- Small diameter barrel grip (only 2-3/8") for easy handling

XMT035 Includes: 18V LXT® Multi-Tool (XMT03Z), (2) 18V LXT® Lithium-Ion 3.0Ah Battery (BL1830B), 18V LXT® Lithium-Ion Rapid Optimum Charger (DC18RC), 1-1/4" Plunge Blade (BIM), 14TPI (A-95255), Multi-Tool Adapter (313249-6), Multi-Tool Adapter (196271-6), Sanding Pad, Multi-Tool TM3000C, LXT (A-95423), 120 Grit Sandpaper (A-95532-1), 180 Grit Sandpaper (A-95548-1), Tool Case

XMT03Z Includes: Tool only, battery & charger not included 1-1/4" Plunge Blade (BIM), 14TPI (A-95255), Multi-Tool Adapter (313249-6), Multi-Tool Adapter (196271-6)

Oscillations Per Minute	6,000 - 20,000 OPM
Oscillation Angle	3.2°
Battery	18V LXT® Lithium-Ion
Overall Length	13-3/8"
Net Weight (with battery)	4.9 lbs.
Shipping Weight	14.33 lbs.



LXT
XOB01T XOB01Z

18V LXT® 5" Random Orbit Sander Kit

- Three speed settings (7,000/9,500/11,000 OPM) engineered for fast material removal
- Up to 65 minutes (low speed) and 32 minutes (high speed) of run time on a single charge
- Large 1/8" random orbit action engineered for faster sanding and swirl-free finish
- One-touch electronic speed control switch provides fast, medium and low settings
- Ergonomically designed body and grip for increased operator comfort
- Pad brake engineered for reduced free-spin and improved overall finish

XOB01T Includes: 18V LXT® Random Orbit Sander (XOB01Z), (2) 18V LXT® Lithium-Ion 5.0Ah Battery (BL1850B), 18V LXT® Lithium-Ion Rapid Optimum Charger (DC18RC), Dust Bag (166078-4), 5" Round Abrasive Disc, Hook & Loop, 120 Grit (794520-1-1), Tool Bag

XOB01Z Includes: Tool only, battery & charger not included Dust Bag (166078-4), 5" Round Abrasive Disc, Hook & Loop, 120 Grit (794520-1-1)

Pad Size (round)	5"
Abrasive Disc Size	5"
Orbits Per Minute (3 speed)	7,000, 9,500, 11,000 OPM
Orbit Diameter	1/8"
Battery	18V LXT® Lithium-Ion
Vibration (m/s²)	2.5
Dimensions (LxWxH)	6-7/8" x 4-7/8" x 6"
Net Weight (with battery)	3.6 lbs.
Shipping Weight	11.8 lbs.



LXT BRUSHLESS
XTR01T8J XTR01Z

18V LXT® Brushless Compact Router Starter Kit

- Starter Kit includes fixed base, straight guide, rapid charger, one battery and case
- LXT® technology delivers 380 feet of cutting performance in red oak using a 1/4" (6mm) straight bit at a 5/32" (4mm) depth with a 5.0Ah battery
- Makita-built brushless motor delivers faster and more accurate cuts in a variety of materials
- Variable speed control dial (10,000 - 30,000 RPM) to match the speed to the application

XTR01T8J Includes: 18V LXT® Brushless Compact Router (XTR01Z), 18V LXT® Lithium-Ion 5.0Ah Battery (BL1850B), 18V LXT® Lithium-Ion Rapid Optimum Charger (DC18RC), Interlocking Case, Large (197212-5), Trimmer Base (196613-4), Straight Guide (122965-7), Spanner Wrench (781011-1), Spanner Wrench (781039-9), 1/4" Collet (763637-1)

XTR01Z Includes: Tool only, battery & charger not included Spanner Wrench (781011-1), Spanner Wrench (781039-9), 1/4" Collet (763637-1), 3/8" Collet (763619-3), Straight Guide (122965-7), Template Guide (343577-5)

Collet	1/4"
No Load Speed (variable speed)	10,000 - 30,000 RPM
Battery	18V LXT® Lithium-Ion
Overall Length	5-1/4"
Net Weight (with battery)	4.6 lbs.
Base	Fixed
Shipping Weight	15.28 lbs.



LXT BRUSHLESS
XTR01T7 XTR01Z

18V LXT® Brushless Compact Router Kit

- LXT® technology delivers 380 feet of cutting performance in red oak using a 1/4" (6mm) straight bit at a 5/32" (4mm) depth with a 5.0Ah battery
- Variable speed control dial (10,000 - 30,000 RPM) to match the speed to the application
- Comes with a plunge base for added versatility, offering a plunge capacity of 0 - 1-3/8" (additional bases and attachments sold separately)

XTR01T7 Includes: 18V LXT® Brushless Compact Router (XTR01Z), (2) 18V LXT® Lithium-Ion 5.0Ah Battery (BL1850B), 18V LXT® Lithium-Ion Rapid Optimum Charger (DC18RC), Interlocking Case, X-Large (197213-3), Trimmer Base (196613-4), Plunge Base (196094-2), Straight Guide (122965-7), Spanner Wrench (781011-1), Spanner Wrench (781039-9), 1/4" Collet (763637-1), 3/8" Collet (763619-3), Template Guide (343577-5), Template Guide 5/8" (344364-5)

XTR01Z Includes: Tool only, battery & charger not included Spanner Wrench (781011-1), Spanner Wrench (781039-9), 1/4" Collet (763637-1), 3/8" Collet (763619-3), Straight Guide (122965-7), Template Guide (343577-5)

Collet	1/4"
No Load Speed (variable speed)	10,000 - 30,000 RPM
Battery	18V LXT® Lithium-Ion
Overall Length	5-1/4"
Net Weight (with battery)	4.6 lbs.
Shipping Weight	20.1 lbs.



LXT
XPK01Z

18V LXT® 3-1/4" Planer

- 2-blade cutter head with double edge carbide blades for added performance and smooth finish
- High power-to-weight ratio; weighs only 7.4 lbs. with battery (battery not included)
- 14,000 RPM motor engineered for faster stock removal
- Click depth adjustment knob with easy-to-read scale with settings from 0" to 5/64"
- Spring-loaded stand elevates the base to protect the blades and workpiece
- Precision machined aluminum base for planing accuracy

XPK01Z Includes: Tool only, battery & charger not included Socket Wrench (782209-3), Blade Set (D-16966), Blade Gauge (123010-1)

Planing Width	3-1/4"
Planing Depth	5/64"
No Load Speed	14,000 RPM
Battery	18V LXT® Lithium-Ion
Overall Length	13-1/8"
Net Weight (with battery)	17.4 lbs.
Shipping Weight	7.5 lbs.



LXT
XJP03Z

18V LXT® Plate Joiner

- Rack-and-pinion vertical fence system engineered for accurate fence adjustments
- Cast aluminum pivot fence with three positive stops at 0°, 45° and 90°, and easy centering on 3/4" material
- Six depth settings with one-touch stops for #0, #10, and #20 and most common biscuits sizes
- Cordless plate joiner provides portability and performance in the field or in the shop without the cord
- Large and easy-to-operate cam locks for angle guide and fence adjustments
- "Tool-less" blade cover and shaft lock for fast and easy blade changes

XJP03Z Includes: Tool only, battery & charger not included 4" Carbide Tipped Blade for Plate Joiner (A-95118), Dust Bag (123150-5), Set Plate (415579-2), Lock Nut Wrench (782401-1)

Blade Diameter	4"
Max. Cutting Depth	3/4"
No Load Speed	12,000 RPM
Battery	18V LXT® Lithium-Ion
Overall Length	13-3/4"
Net Weight (with battery)	6.7 lbs.
Shipping Weight	8.2 lbs.



ANTI-VIBRATION TECHNOLOGY-AVT[®]

BL™ AND AVT[®] DELIVER HIGH POWER AND LOW VIBRATION

PERFORMANCE

X2 LXT[®] technology delivers up to 140 1/2" x 2-3/8" holes per charge using two 18V 5.0Ah batteries

DUST MANAGEMENT

OSHA Table 1 compliant on-board dust extractor has a filter cleaning mechanism for optimum suction



XRH10PTW

18V X2 LXT[®] 36V Brushless 1-1/8" AVT[®] Rotary Hammer Kit, AFT[®], AWS[™] Capable

- X2 LXT[®] technology delivers up to 140 1/2" x 2-3/8" holes per charge using two 18V LXT[®] 5.0Ah batteries
- Powerful BL™ Brushless motor delivers 0-980 RPM, 0-5,000 BPM and 2.3 ft.lbs. of impact energy to handle the most demanding applications
- OSHA Table 1 compliant on-board dust extractor includes a filter cleaning mechanism designed to help maintain optimum suction efficiency
- Active Feedback-Sensing Technology (AFT[®]) electronically turns off the motor if rotation of bit is suddenly forced to stop
- Auto-Start Wireless System (AWS[™]) which utilizes Bluetooth[®] technology for wireless power-on/off communication between tool and dust extractor
- AWS[™] capable with Auto-Start Wireless Transmitter (part no. 198901-5) sold separately
- AVT[®] is an active internal counterbalance system and vibration-absorbing back handle that are engineered to reduce vibration for increased comfort
- Constant speed control automatically applies additional power to the motor to maintain speed under load to complete the most challenging jobs

XRH10PTW Includes: 18V X2 LXT[®] (36V) Brushless 1-1/8" AVT[®] Rotary Hammer, AFT[®] AWS[™] Capable (XRH10Z), Dust Extractor Attachment with HEPA Filter Cleaning Mechanism (DX08), (2) 18V LXT[®] Lithium-Ion 5.0Ah Battery (BL1850B), 18V LXT[®] Lithium-Ion Dual Port Charger (DC18RD), Dust Case with HEPA Filter Cleaning Mechanism (199588-6), Side Handle, Depth Gauge, Tool Bag

XRH10ZW Includes: Tool only, battery & charger not included. Dust Extractor Attachment with HEPA Filter Cleaning Mechanism (DX08), Side Handle, Depth Gauge

Max. Capacity (concrete drilling)	1-9/16"
Optimum Range (concrete drilling)	5/8" - 1-1/4"
Max. Capacity (concrete drilling w/ core bit)	4-1/8"
Impact Energy (ft.lbs.)	8.4
Impact Energy (Joules)	11.4 J
Blows Per Minute (variable speed)	1,450 - 2,900 BPM
No Load Speed (variable speed)	250 - 500 RPM
Vibration Control	Yes
Vibration (m/s ²)	5
Battery	2X 18V LXT [®] Lithium-Ion
Overall Length	18-5/8"
Net Weight	16.8 lbs.
Bit Type	Accepts SDS-MAX

Max. Capacity (concrete drilling)	1-1/8"
Optimum Range (concrete drilling)	3/16" - 5/8"
Max. Capacity (concrete drilling w/ core bit)	2-1/8"
Impact Energy (ft.lbs.)	2.3
Impact Energy (Joules)	3.2 J
Blows Per Minute (variable speed)	0 - 5,000 BPM
No Load Speed (variable speed)	0 - 980 RPM
HEPA filter	Yes
Container Hole Count Capacity	25 holes of dimension 5/8"x2"
Filter Life (Approx. container fillings)	200
Vibration Control	Yes
Vibration (m/s ²)	9
Battery	2X 18V LXT [®] Lithium-Ion
Overall Length	14-3/4"
Net Weight (with battery)	11 lbs.
Bit Type	Accepts SDS-PLUS
Shipping Weight	23.02 lbs.



XRH07PTU

XRH07ZKU

18V X2 LXT[®] (36V) Brushless 1-9/16" Advanced AVT[®] Rotary Hammer Kit, AWS[™]

- Two 18V LXT[®] Lithium-Ion batteries deliver the power and run time for corded demands without leaving the 18V LXT[®] platform
- Powerful BL™ Brushless motor delivers 250-500 RPM, 1,450-2,900 BPM and 8.4 ft.lbs. of impact energy to handle the most demanding applications
- Auto-start Wireless System (AWS[™]) utilizes Bluetooth[®] technology for wireless power-on/off communication between tool and dust extractor

XRH07PTU Includes: 18V X2 LXT[®] (36V) Brushless 1-9/16" Advanced AVT[®] Rotary Hammer, AWS[™] (XRH07ZKU), (2) 18V LXT[®] Lithium-Ion 5.0Ah Battery (BL1850B), 18V LXT[®] Lithium-Ion Dual Port Charger (DC18RD), Auto-Start Wireless Transmitter (198901-5), Side Handle Assembly, Depth Rod, Bit Grease, Tool Case

XRH07ZKU Includes: Tool only, battery & charger not included. Auto-Start Wireless Transmitter (198901-5), Side Handle Assembly, Depth Rod, Bit Grease, Tool Case

Max. Capacity (concrete drilling)	1-9/16"
Optimum Range (concrete drilling)	5/8" - 1-1/4"
Max. Capacity (concrete drilling w/ core bit)	4-1/8"
Impact Energy (ft.lbs.)	8.4
Impact Energy (Joules)	11.4 J
Blows Per Minute (variable speed)	1,450 - 2,900 BPM
No Load Speed (variable speed)	250 - 500 RPM
Vibration Control	Yes
Vibration (m/s ²)	5
Battery	2X 18V LXT [®] Lithium-Ion
Overall Length	18-5/8"
Net Weight	16.8 lbs.
Bit Type	Accepts SDS-MAX



XRH11Z

18V X2 LXT[®] (36V) Brushless 1-1/8" AVT[®] Rotary Hammer Kit, AFT[®], AWS[™] Capable

- X2 LXT[®] technology delivers up to 140 1/2" x 2-3/8" holes per charge using two 18V LXT[®] 5.0Ah batteries (batteries not included)
- Powerful BL™ Brushless motor delivers 0-980 RPM, 0-5,000 BPM and 2.3 ft.lbs. of impact energy to handle the most demanding applications
- Dust extraction capability with optional OSHA Table 1 compliant on-board Dust Extractor Attachment
- Auto-Start Wireless System (AWS[™]) which utilizes Bluetooth[®] technology for wireless power-on/off communication between tool and dust extractor
- AWS[™] capable with Auto-Start Wireless Transmitter (part no. 198901-5) sold separately

XRH11Z Includes: Tool only, battery & charger not included. Quick Change 1/2" Keyless Chuck (19135-3), Side Handle, Depth Gauge

Max. Capacity (concrete drilling)	1-1/8"
Optimum Range (concrete drilling)	3/16" - 5/8"
Max. Capacity (concrete drilling w/ core bit)	2-1/8"
Impact Energy (ft.lbs.)	2.3
Impact Energy (Joules)	3.2 J
Blows Per Minute (variable speed)	0 - 5,000 BPM
No Load Speed (variable speed)	0 - 980 RPM
Vibration Control	Yes
Vibration (m/s ²)	9.5
Battery	2X 18V LXT [®] Lithium-Ion
Overall Length	15-7/8"
Net Weight (with battery)	11.2 lbs.
Bit Type	Accepts SDS-PLUS
Shipping Weight	10.6 lbs.



XRH08PTW

XRH08Z

18V X2 LXT[®] 36V Brushless 1-1/8" AVT[®] Rotary Hammer Kit w/ HEPA Dust Extractor

- X2 LXT[®] technology delivers up to 140 1/2" x 2-3/8" holes per charge using two 18V LXT[®] 5.0Ah batteries
- Powerful BL™ Brushless motor delivers 0-980 RPM, 0-5,000 BPM and 2.3 ft.lbs. of impact energy to handle the most demanding applications
- OSHA Table 1 compliant on-board dust extractor includes a filter cleaning mechanism designed to help maintain optimum suction efficiency
- AVT[®] is an active internal counterbalance system and vibration-absorbing back handle that are engineered to reduce vibration for increased comfort

XRH08PTW Includes: 18V X2 LXT[®] (36V) Brushless 1-1/8" AVT[®] Rotary Hammer (XRH08Z), Dust Extractor Attachment with HEPA Filter Cleaning Mechanism (DX08), (2) 18V LXT[®] Lithium-Ion 5.0Ah Battery (BL1850B), 18V LXT[®] Lithium-Ion Dual Port Charger (DC18RD), Dust Case with HEPA Filter Cleaning Mechanism (199588-6), Side Handle, Depth Gauge, Tool Bag
XRH08Z Includes: Tool only, battery & charger not included. Side Handle, Depth Gauge

Max. Capacity (concrete drilling)	1-1/8"
Optimum Range (concrete drilling)	3/16" - 5/8"
Max. Capacity (concrete drilling w/ core bit)	2-1/8"
Impact Energy (ft.lbs.)	2.3
Impact Energy (Joules)	3.2 J
Blows Per Minute (variable speed)	0 - 5,000 BPM
No Load Speed (variable speed)	0 - 980 RPM
HEPA filter	Yes
Container Hole Count Capacity	25 holes of dimension 5/8"x2"
Filter Life (Approx. container fillings)	200
Vibration Control	Yes
Vibration (m/s ²)	9
Battery	2X 18V LXT [®] Lithium-Ion
Overall Length	14-3/4"
Net Weight (with battery)	10.8 lbs.
Bit Type	Accepts SDS-PLUS
Shipping Weight	23.02 lbs.



XRH08PT

XRH08Z

18V X2 LXT[®] (36V) Brushless 1-1/8" AVT[®] Rotary Hammer Kit

- X2 LXT[®] technology delivers up to 140 1/2" x 2-3/8" holes per charge using two 18V LXT[®] 5.0Ah batteries
- Powerful BL™ Brushless motor delivers 0-980 RPM, 0-5,000 BPM and 2.3 ft.lbs. of impact energy to handle the most demanding applications
- Dust extraction capability with optional OSHA Table 1 compliant On-Board Dust Extractor Attachment
- AVT[®] is an active internal counterbalance system and vibration-absorbing back handle that are engineered to reduce vibration for increased comfort

XRH08PT Includes: 18V X2 LXT[®] (36V) Brushless 1-1/8" AVT[®] Rotary Hammer (XRH08Z), (2) 18V LXT[®] Lithium-Ion 5.0Ah Battery (BL1850B), 18V LXT[®] Lithium-Ion Dual Port Charger (DC18RD), Side Handle, Depth Gauge, Tool Bag

XRH08Z Includes: Tool only, battery & charger not included. Side Handle, Depth Gauge

Max. Capacity (concrete drilling)	1-1/8"
Optimum Range (concrete drilling)	3/16" - 5/8"
Max. Capacity (concrete drilling w/ core bit)	2-1/8"
Impact Energy (ft.lbs.)	2.3
Impact Energy (Joules)	3.2 J
Blows Per Minute (variable speed)	0 - 5,000 BPM
No Load Speed (variable speed)	0 - 980 RPM
Vibration Control	Yes
Vibration (m/s ²)	9
Battery	2X 18V LXT [®] Lithium-Ion
Overall Length	14-3/4"
Net Weight (with battery)	10.8 lbs.
Bit Type	Accepts SDS-PLUS



XRH10Z

18V X2 LXT[®] (36V) Brushless 1-1/8" AVT[®] Rotary Hammer, AFT[®], AWS[™] Capable

- X2 LXT[®] technology delivers up to 140 1/2" x 2-3/8" holes per charge using two 18V LXT[®] 5.0Ah batteries (batteries not included)
- Powerful BL™ Brushless motor delivers 0-980 RPM, 0-5,000 BPM and 2.3 ft.lbs. of impact energy to handle the most demanding applications
- Dust extraction capability with optional OSHA Table 1 compliant On-Board Dust Extractor Attachment
- Active Feedback-Sensing Technology (AFT[®]) electronically turns off the motor if rotation of bit is suddenly forced to stop
- Auto-Start Wireless System (AWS[™]) which utilizes Bluetooth[®] technology for wireless power-on/off communication between tool and dust extractor

XRH10Z Includes: Tool only, battery & charger not included. Side Handle, Depth Gauge

Max. Capacity (concrete drilling)	1-1/8"
Optimum Range (concrete drilling)	3/16" - 5/8"
Max. Capacity (concrete drilling w/ core bit)	2-1/8"
Impact Energy (ft.lbs.)	2.3
Impact Energy (Joules)	3.2 J
Blows Per Minute (variable speed)	0 - 5,000 BPM
No Load Speed (variable speed)	0 - 980 RPM
Vibration Control	Yes
Vibration (m/s ²)	9
Battery	2X 18V LXT [®] Lithium-Ion
Overall Length	14-3/4"
Net Weight (with battery)	9.9 lbs.
Bit Type	Accepts SDS-PLUS
Shipping Weight	9.26 lbs.



XRH05PT

XRH05Z

18V X2 LXT[®] (36V) 1" Rotary Hammer Kit

- Two 18V LXT[®] Lithium-Ion batteries deliver the power and run time for corded demands without leaving the 18V LXT[®] platform
- Makita-built motor delivers 0-1,250 RPM, 0-5,000 BPM and 2.2 ft.lbs. of impact energy for faster drilling
- Vibration-absorbing handle engineered for increased operator comfort
- Dust extraction capability with Makita Dust Attachment, #193472-7 (not included)
- Torque limiting clutch engineered to prevent gear damage by automatically disengaging gears if the bit binds

XRH05PT Includes: 18V X2 LXT[®] (36V) 1" Rotary Hammer (XRH05Z), (2) 18V LXT[®] Lithium-Ion 5.0Ah Battery (BL1850B), 18V LXT[®] Lithium-Ion Dual Port Charger (DC18RD), Side Handle (450990-1), Depth Gauge (324219-0), 20" Contractor Tool Bag (831303-9)

XRH05Z Includes: Tool only, battery & charger not included. Side Handle (450990-1), Depth Gauge (324219-0), Tool Bag (831303-9)

Max. Capacity (concrete drilling)	1"
Optimum Range (concrete drilling)	3/16" - 5/8"
Impact Energy (ft.lbs.)	2.2
Impact Energy (Joules)	3 J
Blows Per Minute (variable speed)	0 - 5,000 BPM
No Load Speed (variable speed)	0 - 1,250 RPM
Vibration Control	Yes
Vibration (m/s ²)	14.5
Battery	2X 18V LXT [®] Lithium-Ion
Overall Length	13-3/4"
Net Weight (with battery)	9.3 lbs.
Shipping Weight	26.2 lbs.
Bit Type	Accepts SDS-PLUS



LXT BRUSHLESS
XRHO11TX XRHO1ZVX

18V LXT® Brushless 1" Rotary Hammer Kit, w/ HEPA Dust Extractor

- Powerful BL™ Brushless motor delivers 0-950 RPM, 0-4,700 BPM and 1.7 ft.lbs. of impact energy to handle the most demanding applications
- The on-board dust extractor attachment captures concrete dust during drilling and is activated by the tool for operator convenience
- Extractor is powered by a separate motor to maintain drilling performance and provide a 2-second delay to help capture remaining dust
- Efficient HEPA filtration system captures 99.97% of particulates .3 microns and larger

XRHO11TX Includes: 18V LXT® Brushless 1" Rotary Hammer (XRHO1Z), (2) 18V LXT® Lithium-Ion 5.0Ah Battery (BL1850B), 18V LXT® Lithium-Ion Rapid Optimum Charger (DC18RC), Dust Extractor Attachment with HEPA Filter (DX01), Side Handle (158057-6), Depth Gauge (324219-0), Tool Bag (831303-9)

XRHO1ZVX Includes: Tool only, battery & charger not included
Dust Extractor Attachment with HEPA Filter (DX01), 20" Contractor Tool Bag (831303-9)

Max. Capacity (concrete drilling)	1"
Optimum Range (concrete drilling)	3/16" - 1/2"
Impact Energy (ft.lbs.)	1.7 J
Impact Energy (Joules)	2.4 J
Blows Per Minute (variable speed)	0 - 4,700 BPM
No Load Speed (variable speed)	0 - 950 RPM
HEPA Filter	Yes
Container Hole Count Capacity	25 holes of dimension 5/8" x2"
Filter Life (Approx. container fillings)	200
Vibration Control	No
Vibration (m/s²)	13.5
Battery	18V LXT® Lithium-Ion
Overall Length	14-5/8"
Net Weight (with battery)	10.2 lbs.
Shipping Weight	19.6 lbs.
Bit Type	Accepts SDS-PLUS



LXT BRUSHLESS
XRHO1T XRHO1Z

18V LXT® Brushless 1" Rotary Hammer Kit

- Powerful BL™ Brushless motor delivers 0-950 RPM, 0-4,700 BPM and 1.7 ft.lbs. of impact energy to handle the most demanding applications
- The BL™ Brushless Motor eliminates carbon brushes, enabling the BL™ Motor to run cooler and more efficiently for longer life
- Compatible with built-on HEPA Dust Extraction Vacuum Attachment part no. DX01 (sold separately) for improved dust extraction mobility
- 3-Mode operation for "Rotation Only", "Hammering with Rotation" or "Hammering Only"

XRHO1T Includes: 18V LXT® Brushless 1" Rotary Hammer (XRHO1Z), (2) 18V LXT® Lithium-Ion 5.0Ah Battery (BL1850B), 18V LXT® Lithium-Ion Rapid Optimum Charger (DC18RC), Side Handle (158057-6), Depth Gauge (324219-0), 20" Contractor Tool Bag (831303-9)

XRHO1Z Includes: Tool only, battery & charger not included
Side Handle (158057-6), Depth Gauge (324219-0)

Max. Capacity (concrete drilling)	1"
Optimum Range (concrete drilling)	3/16" - 1/2"
Impact Energy (ft.lbs.)	1.7
Impact Energy (Joules)	2.4 J
Blows Per Minute (variable speed)	0 - 4,700 BPM
No Load Speed (variable speed)	0 - 950 RPM
Vibration Control	No
Vibration (m/s²)	13.5
Battery	18V LXT® Lithium-Ion
Overall Length	12-7/8"
Net Weight (with battery)	7.2 lbs.
Shipping Weight	19 lbs.
Bit Type	Accepts SDS-PLUS



LXT
XRHO4T XRHO4Z

18V LXT® 7/8" Rotary Hammer Kit

- Makita-built variable speed motor delivers 0-1,200 RPM and 0-4,000 BPM
- 3-mode operation for "Rotation Only", "Hammering with Rotation" or "Hammering Only" for multiple applications
- Torque limiting clutch reduces gear damage by automatically disengaging gears if bit binds
- Faster drilling with synchronized RPM and BPM
- Job site tested shock absorbent handle protects the battery housing for extra durability
- Large 2-finger variable speed trigger for added convenience

XRHO4T Includes: 18V LXT® 7/8" Rotary Hammer (XRHO4Z), (2) 18V LXT® Lithium-Ion 5.0Ah Battery (BL1850B), 18V LXT® Lithium-Ion Rapid Optimum Charger (DC18RC), Side Handle (158057-6), Depth Gauge (324219-0), Tool Bag (821016-X)

XRHO4Z Includes: Tool only, battery & charger not included
Side Handle (158057-6), Depth Gauge (324219-0)

Max. Capacity (concrete drilling)	7/8"
Optimum Range (concrete drilling)	5/32" - 1/2"
Impact Energy (ft.lbs.)	1.4
Impact Energy (Joules)	1.9 J
Blows Per Minute (variable speed)	0 - 4,000 BPM
No Load Speed (variable speed)	0 - 1,200 RPM
Vibration Control	No
Vibration (m/s²)	12.5
Battery	18V LXT® Lithium-Ion
Overall Length	16-3/8"
Net Weight (with battery)	7.7 lbs.
Shipping Weight	16.2 lbs.
Bit Type	Accepts SDS-PLUS



LXT
XRHO3T XRHO3Z

18V LXT® 7/8" Rotary Hammer Kit

- Makita-built variable speed motor delivers 0-1,200 RPM and 0-4,000 BPM
- 3-mode operation for "rotation only", "hammering with rotation" or "hammering only" for multiple applications
- Large 2-finger variable speed trigger for added convenience
- Faster drilling with synchronized RPM and BPM
- One-touch sliding chuck for quick bit changes
- Torque limiting clutch reduces gear damage by automatically disengaging gears if bit binds

XRHO3T Includes: 18V LXT® 7/8" Rotary Hammer (XRHO3Z), (2) 18V LXT® Lithium-Ion 5.0Ah Battery (BL1850B), 18V LXT® Lithium-Ion Rapid Optimum Charger (DC18RC), Side Handle (158057-6), Depth Gauge (324219-0), Tool Bag (158057-6)

XRHO3Z Includes: Tool only, battery & charger not included
Side Handle (158057-6), Depth Gauge (324219-0)

Max. Capacity (concrete drilling)	7/8"
Optimum Range (concrete drilling)	5/32" - 1/2"
Impact Energy (ft.lbs.)	1.4
Impact Energy (Joules)	1.9 J
Blows Per Minute (variable speed)	0 - 4,000 BPM
No Load Speed (variable speed)	0 - 1,200 RPM
Vibration Control	No
Vibration (m/s²)	14.5
Battery	18V LXT® Lithium-Ion
Overall Length	14-1/8"
Net Weight (with battery)	7.7 lbs.
Shipping Weight	16 lbs.
Bit Type	Accepts SDS-PLUS



LXT BRUSHLESS
XRH12TW XRH12ZW

18V LXT® Brushless 11/16" AVT® Rotary Hammer Kit w/ Dust Extractor, AWS™ Capable

- OSHA Table 1 compliant on-board dust extractor includes a filter cleaning mechanism designed to help maintain optimum suction efficiency
- Efficient HEPA filtration system captures 99.97% of particulates .3 microns and larger
- The BL™ Brushless Motor eliminates carbon brushes, enabling the BL™ Motor to run cooler and more efficiently for longer life
- AWS™ utilizes Bluetooth® technology for wireless power-on/off communication between tool and dust extractor (transmitter sold separately)

XRH12TW Includes: 18V LXT® Brushless 11/16" AVT® Rotary Hammer, AWS™ Capable (XRH12Z), (2) 18V LXT® Lithium-Ion 5.0Ah Battery (BL1850B), 18V LXT® Lithium-Ion Rapid Optimum Charger (DC18RC), Dust Extractor Attachment with HEPA Filter Cleaning Mechanism (DX05), Sealing Cap (424474-5), Depth Gauge, Side Handle, Tool Bag

XRH12ZW Includes: Tool only, battery & charger not included
Dust Extractor Attachment with HEPA Filter Cleaning Mechanism (DX05), Sealing Cap (424474-5), Tool bag, Side Handle, Depth Gauge

Max. Capacity (concrete drilling)	11/16"
Optimum Range (concrete drilling)	5/32" - 3/8"
Impact Energy (ft.lbs.)	1.7 J
Impact Energy (Joules)	1.2 J
Blows Per Minute (variable speed)	0 - 5,000 BPM
No Load Speed (variable speed)	0 - 1,350 RPM
Vibration (m/s²)	11
HEPA filter	Yes
Container Hole Count Capacity	36 holes of dimension 3/8" x2-3/8"
Filter Life (Approx. container fillings)	200
Battery	18V LXT® Lithium-Ion
Overall Length	11-7/8"
Net Weight (with battery)	7.5 lbs.
Shipping Weight	19.5 lbs.
Bit Type	Accepts SDS-PLUS



LXT BRUSHLESS
XRH12Z

18V LXT® Brushless 11/16" AVT® Rotary Hammer, AWS™ Capable

- Powerful BL™ Brushless motor delivers 0-1,350 RPM, 0-5,000 BPM and 1.2 ft.lbs. of impact energy to handle the most demanding applications
- Dust extraction capability with optional OSHA Table 1 compliant On-Board Dust Extractor Attachment
- Efficient HEPA filtration system captures 99.97% of particulates .3 microns and larger
- AWS™ utilizes Bluetooth® technology for wireless power-on/off communication between tool and dust extractor (transmitter sold separately)
- Anti-Vibration Technology (AVT™) is engineered to reduce vibration for increased comfort
- 3-mode operation for "Rotation Only", "Hammering with Rotation" or "Hammering Only" for multiple applications

XRH12Z Includes: Tool only, battery & charger not included
Side Handle, Depth Gauge

Max. Capacity (concrete drilling)	11/16"
Optimum Range (concrete drilling)	5/32" - 3/8"
Impact Energy (ft.lbs.)	1.7 J
Impact Energy (Joules)	1.2 J
Blows Per Minute (variable speed)	0 - 5,000 BPM
No Load Speed (variable speed)	0 - 1,350 RPM
Vibration (m/s²)	11
Battery	18V LXT® Lithium-Ion
Overall Length	11-7/8"
Net Weight (with battery)	7.5 lbs.
Bit Type	Accepts SDS-PLUS



LXT BRUSHLESS
XRHO6RBX XRHO6ZB

18V Sub-Compact BL™ 11/16" Rotary Hammer Kit w/ Accessories

- Brushless motor delivers 0-680 RPM, 0-4,800 BPM and .88 ft.lbs./1.2 Joules of impact energy for faster drilling
- Compact and Ergonomic design at only 10-3/4"
- Weighs only 4.6 lbs. with battery for reduced operator fatigue
- Vibration absorbing handle moves independently of the motor and hammer mechanism for increased operator comfort
- Efficient BL™ Brushless motor is electronically controlled to optimize battery energy use for up to 50% longer run time per charge

XRHO6RBX Includes: 18V LXT® Sub-Compact Brushless 11/16" Rotary Hammer (XRHO6ZB), (2) 18V LXT® Lithium-Ion Compact 2.0Ah Battery (BL1820B), 18V LXT® Lithium-Ion Rapid Optimum Charger (DC18RC), Side Handle, Tool Case, 65 pc. Accessory Set

XRHO6ZB Includes: Tool only, battery & charger not included
Depth Gauge (415486-9), Side Handle (144218-4)

Max. Capacity (concrete drilling)	11/16"
Optimum Range (concrete drilling)	5/32" - 3/8"
Impact Energy (ft.lbs.)	.88
Impact Energy (Joules)	1.2 J
Blows Per Minute (variable speed)	0 - 4,800 BPM
No Load Speed (variable speed)	0 - 680 RPM
Vibration Control	Yes
Vibration (m/s²)	9
Battery	18V LXT® Compact Lithium-Ion
Overall Length	10-3/4"
Net Weight	4.6 lbs.
Shipping Weight	7.7 lbs.
Bit Type	Accepts SDS-PLUS



LXT BRUSHLESS
XRHO6RB XRHO6ZB

18V LXT® Sub-Compact Brushless 11/16" Rotary Hammer Kit

- Brushless motor delivers 0-680 RPM, 0-4,800 BPM and .88 ft.lbs./1.2 Joules of impact energy for faster drilling
- Compact and Ergonomic design at only 10-3/4"
- Weighs only 4.6 lbs. with battery for reduced operator fatigue
- Vibration absorbing handle moves independently of the motor and hammer mechanism for increased operator comfort
- Efficient BL™ Brushless motor is electronically controlled to optimize battery energy use for up to 50% longer run time per charge

XRHO6RB Includes: 18V LXT® Sub-Compact Brushless 11/16" Rotary Hammer (XRHO6ZB), (2) 18V LXT® Lithium-Ion Compact 2.0Ah Battery (BL1820B), 18V LXT® Lithium-Ion Rapid Optimum Charger (DC18RC), Tool Bag, Side Handle

XRHO6ZB Includes: Tool only, battery & charger not included
Depth Gauge (415486-9), Side Handle (144218-4)

Max. Capacity (concrete drilling)	11/16"
Optimum Range (concrete drilling)	5/32" - 3/8"
Impact Energy (ft.lbs.)	.88
Impact Energy (Joules)	1.2 J
Blows Per Minute (variable speed)	0 - 4,800 BPM
No Load Speed (variable speed)	0 - 680 RPM
Vibration Control	Yes
Vibration (m/s²)	9
Battery	18V LXT® Compact Lithium-Ion
Overall Length	10-3/4"
Net Weight (with battery)	4.6 lbs.
Shipping Weight	9.702 lbs.
Bit Type	Accepts SDS-PLUS



LXT BRUSHLESS

XRT01TK

XRT01ZK



Includes one battery

LXT BRUSHLESS

AUTOMATIC SPEED CHANGE™

XCS02T1

XCS02ZK



Includes one battery

LXT

XCS01T1

XCS01Z



XRV02T Shown

LXT

XRV02T / XRV01T

XRV02Z

XRV01Z

18V LXT® Brushless Rebar Tying Tool Kit

- Up to 5,300 ties of #3 x #3 diameter rebar using an 18V LXT® 5.0Ah Battery
- Multiple bar tying capability; ties up to two #5 diameter bars or four #4 diameter bars in under 1 second
- 2-mode operation provides single or continuous wire tie actuation for fast and efficient tying
- Fast and seamless wire reel easy-load design with automatic locking mechanism built into protective cover
- The BL™ Brushless Motor eliminates carbon brushes, enabling the BL™ Motor to run cooler and more efficiently
- Trigger power switch with lock-off feature requires two actions to power the tool

XRT01TK Includes: 18V LXT® Brushless Rebar Tying Tool (XRT01ZK), (2) 18V LXT® Lithium-Ion 5.0Ah Battery (BL1850B), 18V LXT® Lithium-Ion Rapid Optimum Charger (DC18RC), Tool Storage Case, Hex Wrench, Belt Clip

XRT01ZK Includes: Tool only, battery & charger not included. Tool Storage Case, Hex Wrench, Belt Clip

Battery	18V LXT® Lithium-Ion
Rebar Size Capacity	#3x#3 - #5x#5
Approx. Ties Per Charge	5,300
Approx. Ties Per Reel	120
Tie Wraps	3
Tying Speed (second)	.8
Continuous Mode	Yes
Tying Strength Levels	6
Wire Diameter (gauge)	21 ga.
Lock-Off Switch	Yes
Auto shut off	Yes
Overall Length	12"
Net Weight	5.7 lbs.
Shipping Weight	18.08 lbs.

18V LXT® Brushless Steel Rod Flush-Cutter Kit

- BL™ Brushless Motor delivers 2,200 RPM for faster spark free cutting
- Automatic Speed Change™ technology adjusts cutting speed and torque during cut for optimum performance
- Spark free cold cutting of rebar, threaded-rod and other metal objects with a carbide-tipped cutting blade
- The electronically-controlled BL™ Brushless Motor efficiently uses energy to match torque and RPM to the changing demands of the application
- Chip collecting bag captures metal cut-offs (optional accessory)

XCS02T1 Includes: 18V LXT® Brushless Steel Rod Flush-Cutter (XCS02ZK), 18V LXT® Lithium-Ion 5.0Ah Battery (BL1850B), 18V LXT® Lithium-Ion Rapid Optimum Charger (DC18RC), 4-5/16" 2AT Carbide-Tipped Blade (SC19002890), Chip Collector (SC08106610), Side Handle, Tool Case, Long Hex Wrench M5

XCS02ZK Includes: Tool only, battery & charger not included. 4-5/16" 2AT Carbide-Tipped Blade (SC19002890), Side Handle (SC08106610), Hex Wrench (M5) (SC08200100), Side Handle, Tool Case,

Blade Diameter	4-5/16"
Cutting Capacity (thickness)	1"
No Load Speed	2,200 RPM
Lock On Switch	Yes
Lock-Off Switch	No
Switch Type	Slide
Battery	18V LXT® Lithium-Ion
Overall Length	18-17/32"
Net Weight (with battery)	8.8 lbs.
Shipping Weight	23.45 lbs.

18V LXT® Rebar Cutter Kit

- Cutting capacity range of 1/8" - 3/4"; cuts up to 60 grade #6 rebar
- 4-way rotatable cutting blade makes up to 4,000 cuts of #3 (3/8") rebar before needing to be replaced
- Cutting head rotates 360° for different cutting positions
- Adjustable stopper holds the rebar at 90° to the cutting blade and assists in smooth cutting
- Ergonomic pistol grip handle with rubberized soft grip provides increased comfort on the job
- Faster and effortless cutting speed of 6.5 seconds for all rebar sizes

XCS01T1 Includes: 18V LXT® Rebar Cutter (XCS01Z), 18V LXT® Lithium-Ion 5.0Ah Battery (BL1850B), 18V LXT® Lithium-Ion Rapid Optimum Charger (DC18RC), Oil, 150 cc (SC00000142), Hex Wrench (783201-2), Hex Wrench (783202-0), Hex Wrench (783203-8), Wrench (783204-6), (781212-1), Tool Case

XCS01Z Includes: Tool only, battery & charger not included. Oil, 150 cc (SC00000142), Hex Wrench (783201-2), Hex Wrench (783202-0), Hex Wrench (783203-8), Wrench (783204-6), (781212-1), Tool Case

Blade Configuration	Double sided
Cutting Capacity (thickness)	3/4"
Battery	18V LXT® Lithium-Ion
Overall Length	16-1/5"
Net Weight (with battery)	24.3 lbs.
Shipping Weight	39 lbs.

18V LXT® 8" Concrete Vibrator Kit

- Makita-built motor delivers 12,500 VPM to help increase strength of concrete
- Dual directional switch to conveniently hold the tool in either horizontal or vertical positions
- Up to 41 minute run-time under load with 18V LXT® Lithium-Ion 5.0Ah battery
- Compact and ergonomic design at only 105-1/2" long (XRV02T) & 58-1/2" (XRV01T)
- Weights only 11.4 lbs. (XRV02T) & 7.7 lbs. (XRV01T) with battery for reduced operator fatigue
- Protective cover helps prevent battery contamination

XRV02T & XRV01T Include: 18V LXT® Concrete Vibrator, (2) 18V LXT® Lithium-Ion 5.0Ah Battery (BL1850B), 18V LXT® Lithium-Ion Rapid Optimum Charger (DC18RC), Tool Case

XRV02Z & XRV01Z Include: Tool only, battery & charger not included

No Load Vibrations/Min.	XRV02T (12,500), XRV01T (13,000)
Vibrator Head Diameter	1"
Battery	18V LXT® Lithium-Ion
Vibrator Head Length	8-11/16"
Shaft Length:	XRV02T (96"), XRV01T (48")
Battery	18V LXT® Lithium-Ion
Overall Length:	XRV02T (105-1/2"), XRV01T (58-1/2")
Net Weight (with battery):	XRV02T (11.4 lbs.), XRV01T (7.7 lbs.)
Shipping Weight:	XRV02T (22 lbs.), XRV01T (19 lbs.)

POWER EQUIPMENT



LXT BRUSHLESS

XCU04PT

XCU04Z

18V X2 (36V) LXT® Brushless 16" Chain Saw Kit

- Makita-built Outer Rotor BL™ Brushless Motor direct-drive system provides high power efficiency equivalent to a 32cc gas chain saw
- Two 18V LXT® Lithium-Ion batteries deliver 36V power and performance without leaving the 18V LXT® platform
- "Tool-less" chain adjustment for convenient operation and maintenance
- Variable speed trigger and high chain speed (0-3,940 FPM) for improved cutting performance
- Adjustable automatic chain lubrication with large oil reservoir

XCU04PT Includes: 18V X2 (36V) LXT® Brushless 16" Chain Saw (XCU04Z), (2) 18V LXT® Lithium-Ion 5.0Ah Battery (BL1850B), 18V LXT® Lithium-Ion Dual Port Charger (DC18RD), 16" Saw Chain, 3/8", .043" (196742-3), 16" Guide Bar, 3/8", .043" (165247-4), 16" Bar Cover

XCU04Z Includes: Tool only, battery & charger not included. 16" Saw Chain, 3/8", .043" (196742-3), 16" Guide Bar, 3/8", .043" (165247-4), Guide Bar Cover (419288-5)

Guide Bar Length	16"
Pitch	3/8"
Gauge	.043"
Chain Speed	3,940 FPM
Net Weight (with battery)	11.8 lbs.
Battery	2X 18V LXT® Lithium-Ion
Overall Length	32-1/4"
Shipping Weight	19.2 lbs.



LXT BRUSHLESS

XCU07PT

XCU07Z

18V X2 (36V) LXT® Brushless 14" Chain Saw Kit

- Makita-built Outer Rotor BL™ Brushless Motor direct-drive system provides high power efficiency equivalent to a 32cc gas chain saw
- Two 18V LXT® Lithium-Ion batteries deliver 36V power and performance without leaving the 18V LXT® platform
- Captured bar nuts and lateral chain tensioning for convenient operation and maintenance
- Variable speed trigger and high chain speed (0-3,940 FPM) for improved cutting performance
- Adjustable automatic chain lubrication with large oil reservoir

XCU07PT Includes: 18V X2 (36V) LXT® Brushless 14" Chain Saw (XCU07Z), (2) 18V LXT® Lithium-Ion 5.0Ah Battery (BL1850B), 18V LXT® Lithium-Ion Dual Port Charger (DC18RD), 14" Guide Bar, 3/8", .043" (165246-6), 14" Saw Chain, 3/8", .043" (196741-5), 14" Chain Cover (419242-9), Scrench

XCU07Z Includes: Tool only, battery & charger not included. 14" Guide Bar, 3/8", .043" (165246-6), 14" Saw Chain, 3/8", .043" (196741-5), 14" Chain Cover (419242-9), Srench

Guide Bar Length	14"
Pitch	3/8"
Gauge	.043"
Chain Speed	3,940 FPM
Net Weight (with battery)	11.5 lbs.
Battery	2X 18V LXT® Lithium-Ion
Power Type	Cordless
Shipping Weight	18.9 lbs.



LXT BRUSHLESS

XCU03PT

XCU03Z

18V X2 (36V) LXT® Brushless 14" Chain Saw Kit

- Makita-built Outer Rotor BL™ Brushless Motor direct-drive system provides high power efficiency equivalent to a 32cc gas chain saw
- Two 18V LXT® Lithium-Ion batteries deliver 36V power and performance without leaving the 18V LXT® platform
- "Tool-less" chain adjustment for convenient operation and maintenance

XCU03PT Includes: 18V X2 (36V) LXT® Brushless 14" Chain Saw (XCU03Z), (2) 18V LXT® Lithium-Ion 5.0Ah Battery (BL1850B), 18V LXT® Lithium-Ion Dual Port Charger (DC18RD), 14" Guide Bar, 3/8", .043" (165246-6), 14" Saw Chain, 3/8", .043" (196741-5), 14" Chain Cover (419242-9)

XCU03Z Includes: Tool only, battery & charger not included. 14" Guide Bar, 3/8", .043" (165246-6), 14" Saw Chain, 3/8", .043" (196741-5), 14" Chain Cover (419242-9)

Guide Bar Length	14"
Pitch	3/8"
Gauge	.043"
Chain Speed	3,940 FPM
Net Weight (with battery)	11.5 lbs.
Battery	2X 18V LXT® Lithium-Ion
Overall Length	30-1/2"
Shipping Weight	18.9 lbs.



LXT X2 18V + 18V 36V

XCU02PT

XCU02Z

18V X2 (36V) LXT® 12" Chain Saw Kit

- Makita-built motor delivers 1,650 FPM chain speed for faster cutting
- Two 18V LXT® Lithium-Ion batteries deliver power and performance without leaving the 18V LXT® platform
- "Tool-less" chain adjustment for convenient operation and maintenance
- Low noise level at only 87 dB(A) and zero emissions for operator comfort
- 12" guide bar for increased capacity
- Weights only 10.1 lbs. with batteries for reduced operator fatigue

XCU02PT Includes: 18V X2 (36V) LXT® 12" Chain Saw (XCU02Z), (2) 18V LXT® Lithium-Ion 5.0Ah Battery (BL1850B), 18V LXT® Lithium-Ion Dual Port Charger (DC18RD), 12" Guide Bar (165245-8), 12" Saw Chain 3/8", .043" (531-291-646), Spike Bar (197819-7)

XCU02Z Includes: Tool only, battery & charger not included. 12" Guide Bar (165245-8), 12" Saw Chain 3/8", .043" (531-291-646), Spike Bar (197819-7), Blade Cover

Guide Bar Length	12"
Pitch	3/8"
Gauge	.043"
Chain Speed	1,650 FPM
Net Weight (with battery)	10.1 lbs.
Battery	2X 18V LXT® Lithium-Ion
Overall Length	24-5/8"
Shipping Weight	19.8 lbs.



LXT BRUSHLESS

XCXU06T XCXU06Z

18V LXT® Brushless 10" Top Handle Chain Saw Kit

- Compact top handle design built for the professional tree care industry
- Makita-built Outer Rotor BL™ Brushless Motor direct-drive system provides high power efficiency
- Torque boost mode for cutting dense material
- Captured bar nut and lateral chain tensioning for convenient operation and maintenance
- Variable speed trigger and high chain speed (0-4,720 FPM) for improved cutting performance

XCXU06T Includes: (2) 18V LXT® Lithium-Ion 5.0Ah Battery (BL1850B), 18V LXT® Lithium-Ion Rapid Optimum Charger (DC18RC), 10" Guide Bar, 3/8", .043" (161846-0), 10" Saw Chain, 3/8", .043" (199075-5), Bumper Spike (199068-2), Universal Wrench, 13mm x 16mm (782023-7)

XCXU06Z Includes: Tool only, battery & charger not included 10" Guide Bar, 3/8", .043" (161846-0), 10" Saw Chain, 3/8", .043" (199075-5), Bumper Spike (199068-2), Universal Wrench, 13mm x 16mm (782023-7)

Guide Bar Length	10"
Pitch	3/8"
Gauge	.043"
Chain Speed	4,720 FPM
Net Weight (with battery)	7.2 lbs.
Battery	18V LXT® Lithium-Ion
Overall Length	19-3/8"
Shipping Weight	13.35 lbs.



LXT

XCXU01Z

18V LXT® 4-1/2" Chain Saw

- 4-1/2" guide bar is ideal for limbing
- Makita-built motor delivers 980 FPM for increased cutting speed
- "Tool-less" chain adjustments for convenient operation and maintenance
- Compact and ergonomic design at only 16-5/8" long
- Electric brake for maximum productivity
- Compact and ergonomic design at only 16-5/8" long
- Weighs only 5.4 lbs. with battery (battery not included) for reduced operator fatigue
- Adjustable automatic chain lubrication with large oil reservoir

XCXU01Z Includes: Tool only, battery & charger not included 4-1/2" Chain Saw Chain, 1/4", .050" (791284-8), 4-1/2" Guide Bar (158479-6), Bar and Chain Oil, 1 Gallon (181116-A), Bar and Chain Oil, Winter, 1 Gallon (T-03159), Combo Safety Helmet (986-200-002), Chain Saw Chaps (841008-A)

Guide Bar Length	4-1/2"
Pitch	1/4"
Gauge	.050"
Chain Speed	980 FPM
Net Weight (with battery)	5.4 lbs.
Battery	18V LXT® Lithium-Ion
Overall Length	16-5/8"
Shipping Weight	7.1 lbs.



LXT BRUSHLESS

XBU02PT XBU02Z

18V X2 (36V) LXT® Brushless Blower Kit

- Delivers up to 28 minutes of run time at mid-speed (15,800 RPM) using two 18V LXT® 5.0Ah batteries
- BL™ Brushless motor delivers up to 120 MPH air velocity and 473 CFM of air volume
- Sound pressure rating of 61 dB(A); measured per ANSI B 175.2 standard
- Zero emissions and reduced maintenance; no need for gas or oil
- 6-stage air velocity/volume selection dial with variable speed control trigger
- Two 18V LXT® Lithium-Ion batteries deliver the power and run time for gas powered demands without leaving the 18V LXT® platform

XBU02PT Includes: 18V X2 (36V) LXT® Brushless Blower (XBU02Z), (2) 18V LXT® Lithium-Ion 5.0Ah Battery (BL1850B), 18V LXT® Lithium-Ion Dual Port Charger (DC18RD)

XBU02Z Includes: Tool only, battery & charger not included 3-Stage Telescoping Blower Nozzle (455915-0)

Max. Air Volume	473 CFM
Max. Air Velocity	120 MPH
No Load Speed (variable speed)	11,400 - 21,500 RPM
Battery	2X 18V LXT® Lithium-Ion
Sound Pressure (per Ansi B175.2 standard)	61 dB(A)
Overall Length	36-5/8"
Net Weight (with battery)	9 lbs.
Shipping Weight	17.6 lbs.



LXT X2 18V + 18V 36V

XBU01PT XBU01Z

18V X2 (36V) LXT® Blower Kit

- Delivers up to 28 minutes of run time using two 5.0Ah 18V LXT® batteries on highest speed setting
- Makita-built motor produces a maximum air velocity of 208 MPH and 155 CFM of air volume
- 2-speed (Low: 10,000 RPM, High: 17,000 RPM) design to match the speed to application
- Two 18V LXT® Lithium-Ion batteries deliver the power and run time for corded demands without leaving the 18V LXT® platform
- Zero emissions and reduced maintenance for increased ease of use

XBU01PT Includes: 18V X2 (36V) LXT® Blower (XBU01Z), (2) 18V LXT® Lithium-Ion 5.0Ah Battery (BL1850B), 18V LXT® Lithium-Ion Dual Port Charger (DC18RD)

XBU01Z Includes: Tool only, battery & charger not included Long Blower Nozzle (452123-4)

Max. Air Volume	155 CFM
Max. Air Velocity	208 MPH
No Load Speed (2 spd)	10,000/17,000 RPM
Battery	2X 18V LXT® Lithium-Ion
Sound Pressure (per Ansi B175.2 standard)	60.6 dB(A)
Overall Length	36-1/4"
Net Weight (with battery)	8 lbs.
Shipping Weight	13.1 lbs.



LXT

DUB183Z

18V LXT® Floor Blower

- Up to 18 minutes of continuous operation at high speed using 18V LXT® 5.0Ah battery BL1850B (battery not included)
- Variable speed (0-18,000 RPM) for optimum air volume control enables user to match the speed to the application
- Makita-built variable 3-speed motor produces a maximum air velocity of 116 MPH and 91 CFM of air volume
- Long nozzle with a curved flat end enables comfortable operation of blower in an upright standing position
- Zero emissions and reduced maintenance; no need for gas or oil
- Compact and ergonomic design at only 33-1/4" long

DUB183Z Includes: Tool only, battery & charger not included Long Blower Nozzle (TP0000199)

Max. Air Volume	91 CFM
Max. Air Velocity	116 MPH
No Load Speed (variable speed)	0 - 18,000 RPM
Battery	18V LXT® Lithium-Ion
Overall Length	33-1/4"
Net Weight (with battery)	4.3 lbs.
Shipping Weight	4.3 lbs.



LXT

DUB182T1

DUB182Z

18V LXT® Blower Kit

- Variable speed (0-18,000 RPM) for optimum speed control
- Up to 20 minutes of continuous operation at high speed with a 5.0Ah LXT® battery
- Compact and ergonomic design at only 20-3/4" long
- Weighs only 3.9 lbs. with battery for reduced operator fatigue
- Rubberized soft grip handle for increased operator comfort
- Makita-built variable 3-speed motor produces a maximum air velocity of 179 MPH

DUB182T1 Includes: 18V LXT® Blower (DUB182Z), 18V LXT® Lithium-Ion 5.0Ah Battery (BL1850B), 18V LXT® Lithium-Ion Rapid Optimum Charger (DC18RC), Rubber Blower Nozzle (132025-7), 20" Contractor Tool Bag (831303-9)

DUB182Z Includes: Tool only, battery & charger not included Rubber Blower Nozzle (132025-7)

Max. Air Volume	91 CFM
Max. Air Velocity	179 MPH
No Load Speed (variable speed)	0 - 18,000 RPM
Battery	18V LXT® Lithium-Ion
Overall Length	20-3/4"
Net Weight (with battery)	3.9 lbs.
Shipping Weight	10.8 lbs.



LXT BRUSHLESS

XRU09PT XRU09Z

18V X2 (36V) LXT® Brushless String Trimmer Kit

- Makita-built Outer Rotor BL™ Brushless Motor direct-drive system provides high power and increased torque
- 2-speed options (Low: 5,000 RPM, High: 6,500 RPM) allows the operator to match speed to application
- Delivers up to 60 minutes of run time under load on the low speed setting using two 18V LXT® 5.0Ah BL1850 batteries
- Bump and Feed trimmer head rotates the same counterclockwise direction as professional grade trimmers
- Accepts industry standard spindles M10x1.25 LH for more convenience

XRU09PT Includes: 18V X2 (36V) LXT® Brushless String Trimmer (XRU09Z), Bump & Feed Trimmer Head, M10 X 1.25 LH (197296-3), (2) 18V LXT® Lithium-Ion 5.0Ah Battery (BL1850B)

XRU09Z Includes: Tool only, battery & charger not included

Cutting Capacity (diameter)	13-3/4"
No Load Speed (2 spd)	5,000/6,500 RPM
Battery	2X 18V LXT® Lithium-Ion
Overall Length	69"
Net Weight (with battery)	9.9 lbs.
Shipping Weight	18.8 lbs.



LXT BRUSHLESS

XRU11M1

XRU11Z

18V LXT® Brushless String Trimmer Kit

- Up to 30 minutes of run time with 4.0Ah battery under load on the high setting
- BL™ Brushless motor delivers up to 6,000 RPM for faster cutting
- Automatic Torque Drive Technology automatically shifts from 4,000-6,000 RPM depending on density of application
- 3-speed options (Low: 4,000 RPM, Medium: 5,000 RPM, High: 6,000 RPM) allows the operator to match speed to application
- 11-3/4" cutting swath for user convenience

XRU11M1 Includes: 18V LXT® Brushless String Trimmer (XRU11Z), 18V LXT® Lithium-Ion 4.0Ah Battery (BL1840B), 18V LXT® Lithium-Ion Rapid Optimum Charger (DC18RC), Shoulder Strap, Safety Goggles

XRU11Z Includes: Tool only, battery & charger not included Bump & Feed Trimmer Head, M8 X 1.25 LH (198386-5), Shoulder Strap (125516-5), Goggles (195246-2), Hex Wrench (783217-7), Hex Wrench (783202-0), Accessory Bag (831304-7)

Cutting Capacity (diameter)	11-3/4"
No Load Speed (2 spd)	4,000/6,000 RPM
Battery	18V LXT® Lithium-Ion
Overall Length	70-1/2"
Net Weight (with battery)	7.4 lbs.
Shipping Weight	14.7 lbs.



LXT BRUSHLESS
XRU13Z

18V LXT® Brushless Curved Shaft String Trimmer

- Automatic Speed Change™ technology automatically adjusts cutting speed (4,000-6,000 RPM) and torque depending on density of application
- Manual operation mode features 3-speed options (Low: 4,000 RPM, Medium: 5,000 RPM, High: 6,000 RPM) allows the operator to match speed to application
- Telescoping curved shaft adjusts (59-1/2" - 63-1/2" length) for convenient operation in tight places
- BL™ Brushless motor delivers up to 6,000 RPM for faster cutting
- Up to 38 minutes of run time on high setting and 103 minutes on low setting under load using 18V LXT® 5.0Ah battery BL1850B (battery not included)
- 11-3/4" cutting swath for user convenience

XRU13Z Includes: Tool only, battery & charger not included
Shoulder Strap (125516-5), Trimmer Head

Shipping Weight	10.12 lbs.
Voltage	18V
Brushless Motor	Yes
Arbor Shaft	M8 x 1.25 RH
No Load Speed (3 spd)	4,000/5,000/6,000 RPM



LXT
XR002Z

18V LXT® String Trimmer

- Up to 60 minutes of run time under no load using 5.0Ah battery BL1850B (battery not included)
- Telescoping shaft (48-1/2" to 56-1/2") for optimum cutting position
- Makita-built motor delivers 7,800 RPM for faster cutting
- Adjustable 5-position pivoting head for cutting angle adjustment when trimming in tight spaces
- 180° rotating head allows the trimmer to convert to edger; 10-1/4" cutting width
- Weighs only 6.4 lbs. with battery (battery not included) for reduced operator fatigue

XR002Z Includes: Tool only, battery & charger not included
Bump & Feed Trimmer Head (195858-1)

Cutting Capacity (diameter)	10-1/4"
No Load Speed	7,800 RPM
Battery	18V LXT® Lithium-Ion
Overall Length	56-1/2"
Net Weight (with battery)	6.4 lbs.
Shipping Weight	8.8 lbs.

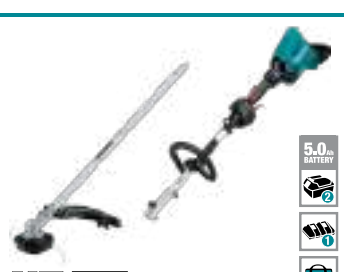

LXT BRUSHLESS
XUX01M5PT **XUX01ZM5**

18V X2 (36V) LXT® Brushless Couple Shaft Power Head Kit with Trimmer Attachment

- BL™ Brushless motor delivers up to 9,700 RPM for faster cutting
- 3-speed options (Low: 5,700 RPM, Medium: 8,200 High: 9,700 RPM) allow the operator to match speed to application
- Compatible with a variety of optional couple shaft attachments for versatility
- Lever style lock system allows for quick tool-less installation and replacement of attachments

XUX01M5PT Includes: 18V X2 (36V) LXT® Brushless Couple Shaft Power Head (XUX01Z), String Trimmer Couple Shaft Attachment (EM405MP), 18V LXT® Lithium-Ion Dual Port Charger (DC18RD), (2) 18V LXT® Lithium-Ion 5.0Ah Battery (BL1850B), Shoulder Strap (125516-5), 46" Contractor Tool Bag (195638-5)

XUX01ZM5 Includes: Tool only, battery & charger not included
18V X2 (36V) LXT® Brushless Couple Shaft Power Head (XUX01Z), String Trimmer Couple Shaft Attachment (EM405MP), Shoulder Strap (125516-5), 46" Contractor Tool Bag (195638-5)

Cutting Capacity (diameter)	17"
No Load Speed (var. 3 spd.)	0 - 9,700 / 0 - 8,200 / 0 - 5,700 RPM
Battery	2X 18V LXT® Lithium-Ion
Overall Length	69"
Net Weight (with battery)	17.2 lbs.
Shaft Type	Multi-tool attachment
Shipping Weight	31.11 lbs.

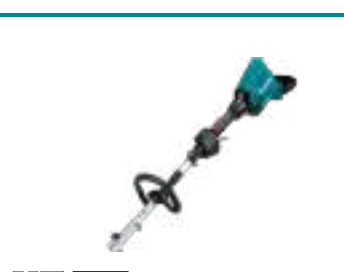

LXT BRUSHLESS
XUX01Z

18V X2 (36V) LXT® Brushless Couple Shaft Power Head

- BL™ Brushless motor delivers up to 9,700 RPM
- 3-speed options (Low: 5,700 RPM, Medium: 8,200 High: 9,700 RPM) allows the operator to match speed to application
- Compatible with a variety of optional couple shaft attachments for versatility
- Lever style lock system allows for quick tool-less installation and replacement of attachments
- Electronic Torque Control turns the motor off if rotation speed suddenly slows or wheel is forced to stop

XUX01Z Includes: Tool only, battery & charger not included
Shoulder Strap (125516-5)

Shaft Type	Multi-tool attachment
No Load Speed (var. 3 spd.)	0 - 9,700 / 0 - 8,200 / 0 - 5,700 RPM
Battery	2X 18V LXT® Lithium-Ion
Overall Length	39-3/4"
Net Weight (with battery)	9.8 lbs.
Shipping Weight	10.6 lbs.

ULTIMATE VERSATILITY

LXT® BRUSHLESS CORDLESS COUPLE SHAFT POWER HEAD

The Makita® LXT® cordless power head is compatible with a variety of couple shaft attachments for trimming, edging, cultivating and brush cutting. Powered by two LXT® batteries for maximum performance and run time without the hassles of gas, this tool is a welcome solution for a range of outdoor trimming and cutting applications.

SEE MORE // pg.120



<p>EM400MP Brush Cutter Couple Shaft Attachment</p> <p>Large multi-purpose grass shield, can be used with trimmer head (included) or grass blade (optional)</p>	<p>EM405MP String Trimmer Couple Shaft Attachment</p> <p>M10 x 1.25 LH shaft arbor fits common sized trimmer heads</p>	<p>ER400MP Curved String Trimmer Couple Shaft Attachment</p> <p>M8 x 1.25 RH shaft arbor fits common sized trimmer heads</p>	<p>EY401MP 10" Pole Saw Couple Shaft Attachment</p> <p>10" reversible sprocket nose bar for efficient pruning of branches</p>	<p>EN401MP 20" Articulating Hedge Trimmer Couple Shaft Attachment</p> <p>20" double-sided blade with 13 angle settings for efficient trimming of overhead and low-lying hedges</p>
<p>EN410MP 20" Double-Sided Hedge Trimmer Couple Shaft Attachment</p> <p>20" double-sided blade with higher blade speed for efficient cutting of hedges</p>	<p>KR401MP Cultivator Couple Shaft Attachment</p> <p>9" 6 tine steel blade for efficient rejuvenation of planting areas</p>	<p>LE400MP 42" Shaft Extension Couple Shaft Attachment</p> <p>42" extended shaft reach allowing access to hard-to-reach branches and shrubs</p>	<p>SW400MP Paddle Sweep Couple Shaft Attachment</p> <p>Wide sweeping surface of 23-1/4" for maximum productivity</p>	<p>BR400MP Bristle Brush Couple Shaft Attachment</p> <p>Wide sweeping surface of 23-5/8" for maximum productivity</p>



LXT BRUSHLESS

XHU07T **XHU07Z**

18V LXT® Brushless 24" Hedge Trimmer Kit

- 5-position rotating rear handle for increased comfort during vertical and angle trimming
- 3-speed options (Low: 2,000 SPM, Medium: 3,600 SPM, High: 4,400 SPM) allowing the operator to match speed to application
- Variable speed trigger for increased operator control
- Anti-vibration design aids in precision cutting
- 24" blade provides increased cutting capacity
- Features Extreme Protection Technology (XPT™) which is engineered to provide increased dust and water resistance in harsh job site conditions

XHU07T Includes: (2) 18V LXT® Lithium-Ion 5.0Ah Battery (BL1850B), 18V LXT® Lithium-Ion Rapid Optimum Charger (DC18RC), Hedge Trimmer Blade Cover,

XHU07Z Includes: Tool only, battery & charger not included Hedge Trimmer Blade Cover

Blade Length	24"
Strokes Per Minute	4,400 SPM
Overall Length	44-1/4"
Battery	18V LXT® Lithium-Ion
Net Weight (without battery)	7.3 lbs.



LXT BRUSHLESS

XHU08T **XHU08Z**

18V LXT® Brushless 30" Hedge Trimmer Kit

- 5-position rotating rear handle for increased comfort during vertical and angle trimming
- 3-speed options (Low: 2,000 SPM, Medium: 3,600 SPM, High: 4,400 SPM) allowing the operator to match speed to application
- Variable speed trigger for increased operator control
- Anti-vibration design aids in precision cutting
- 30" blade provides increased cutting capacity
- Features Extreme Protection Technology (XPT™) which is engineered to provide increased dust and water resistance in harsh job site conditions

XHU08T Includes: (2) 18V LXT® Lithium-Ion 5.0Ah Battery (BL1850B), 18V LXT® Lithium-Ion Rapid Optimum Charger (DC18RC), Hedge Trimmer Blade Cover

XHU08Z Includes: Tool only, battery & charger not included Hedge Trimmer Blade Cover

Blade Length	30"
Strokes Per Minute	4,400 SPM
Overall Length	49-3/4"
Battery	18V LXT® Lithium-Ion
Net Weight (without battery)	7.7 lbs.



LXT X2 18V + 18V 36V

XHU04PT **XHU04Z**

18V X2 (36V) LXT® 25-1/2" Hedge Trimmer Kit

- Delivers up to 60 minutes of run time on high setting under load using two 5.0Ah BL1850B batteries
- 6 speed dial (0 - 1,800 SPM) allows the user to match the speed to the application
- 25-1/2" blade provides increased cutting capacity
- 5-position rotating rear handle for increased comfort during vertical and angle trimming
- Makita-built motor delivers 1,800 SPM for faster cutting
- Lower noise level at only 86.5 dB(A); up to 30% quieter than gas

XHU04PT Includes: 18V X2 (36V) LXT® 25-1/2" Hedge Trimmer (XHU04Z), (2) 18V LXT® Lithium-Ion 5.0Ah Battery (BL1850B), 18V LXT® Lithium-Ion Dual Port Charger (DC18RD), Blade Cover (1)

XHU04Z Includes: Tool only, battery & charger not included Blade Cover

Blade Length	25-1/2"
Strokes Per Minute	1,800 SPM
Battery	2X 18V LXT® Lithium-Ion
Overall Length	48-3/4"
Net Weight (with battery)	12.2 lbs.
Shipping Weight	21.4 lbs.



LXT

XHU02M1 **XHU02Z**

18V LXT® 22" Hedge Trimmer Kit

- Up to 120 minutes of run time under no load using 4.0Ah battery BL1840B on lowest setting
- Makita-built motor delivers 1,350 SPM for increased cutting speed
- 22" blade provides increased cutting capacity
- Anti-vibration design (five cushions within the motor housing) helps minimize vibration
- Battery capacity warning system; motor stops and light goes on indicating battery needs recharging
- Lower noise level at only 87 dB(A) for operator comfort

XHU02M1 Includes: 18V LXT® 22" Hedge Trimmer (XHU02Z), 18V LXT® Lithium-Ion 4.0Ah Battery (BL1840B), 18V LXT® Lithium-Ion Rapid Optimum Charger (DC18RC), Blade Cover

XHU02Z Includes: Tool only, battery & charger not included Blade Cover (450490-1)

Blade Length	22"
Strokes Per Minute	1,350 SPM
Battery	18V LXT® Lithium-Ion
Overall Length	38"
Net Weight (with battery)	7.4 lbs.
Shipping Weight	12.8 lbs.



LXT

XMU04Z

18V LXT® Grass Shear

- Makita-built motor delivers 2,500 SPM for efficient cutting
- Up to 200 minutes of run time with 5.0Ah battery BL1850B (battery not included)
- 6-5/16" cutting width for optimum performance
- Dual blade action cuts with a shearing effect for improved results
- Easy to operate 3 stage cutting height adjustment (19/32", 25/32", 1")
- "Tool-less" blade changing system for increased convenience

XMU04Z Includes: Tool only, battery & charger not included Blade Guard, Grass Receiver

Cutting Capacity (width)	6-5/16"
Depth Adjustment Range	9/32", 25/32", 1"
Strokes Per Minute	2,500 SPM
Battery	18V LXT® Lithium-Ion
Overall Length	13-7/8"
Net Weight (with battery)	4.1 lbs.
Shipping Weight	3.6 lbs.



LXT X2 18V + 18V 36V

XML02PT **XML02Z**

18V X2 (36V) LXT® 17" Cordless Lawn Mower Kit

- Delivers up to 30 minutes of run time using two 18V LXT® 5.0Ah BL1850 batteries
- Makita-built motor delivers 3,600 RPM for faster and powerful cutting
- Easy to operate lever for quick adjustment of 13 cutting heights (13/16" - 2-5/16")
- Soft start suppresses start-up reaction for smooth start-ups and longer gear life
- 17" cutting width for optimum performance
- Grass catcher bag holds up to 13 gallons of grass

XML02PT Includes: 18V X2 (36V) LXT® 17" Lawn Mower (XML02Z), (2) 18V LXT® Lithium-Ion 5.0Ah Battery (BL1850B), 18V LXT® Lithium-Ion Dual Port Charger (DC18RD), Grass Catcher Bag (126621-1)

XML02Z Includes: Tool only, battery & charger not included Grass Catcher Bag (126621-1)

Cutting Capacity (width)	17"
Cutting Capacity (height range)	13/16" - 2-5/16"
No Load Speed	3,600 RPM
Battery	2X 18V LXT® Lithium-Ion
Dimensions (LxWxH)	58-3/4" x 18-1/8" x 37-1/2"
Net Weight (with battery)	40.8 lbs.
Shipping Weight	



LXT BRUSHLESS

XUC01PTX1 **XUC01X1**

18V X2 LXT® Brushless Power-Assisted Wheelbarrow Kit

- Delivers up to 45 minutes of run time under load using one 18V LXT® 5.0Ah battery
- Holds (2) 18V LXT® Lithium-Ion batteries but operates using (1) 18V battery at a time; utilizes second battery when needed
- Makita-built BL™ Brushless Motor for optimal performance
- 2-speed with maximum speed up to 2.5 MPH on a 12° incline
- Reversible for versatility and convenience

XUC01PTX1 Includes: 18V X2 LXT® Brushless Power-Assisted Hand Truck/Wheelbarrow (XUC01Z), (2) 18V LXT® Lithium-Ion 5.0Ah Battery (BL1850B), 18V LXT® Lithium-Ion Dual Port Charger (DC18RD), Steel Bucket (198494-2), L-Shaped Legs, (2) Rear Wheel

XUC01X1 Includes: Tool only, battery & charger not included 18V X2 LXT® Brushless Power-Assisted Hand Truck/Wheelbarrow (XUC01Z), Steel Bucket (198494-2), L-Shaped Legs, (2) Rear Wheel

Speed Forward (High/Low MPH)	2.5 / 1 MPH
Speed Reverse (MPH)	.62 MPH
Max. Load Capacity	275 lbs.
Max. Grade	12°
Battery	2X 18V LXT® Lithium-Ion
Dimensions (LxWxH)	43-3/4" x 23-1/4" x 32-1/4"
Net Weight	87.2 lbs.
Shipping Weight	125 lbs.



LXT BRUSHLESS

XUC01PTX2 **XUC01X2**

18V X2 LXT® Brushless Power-Assisted Flat Dolly Kit

- Delivers up to 45 minutes of run time under load using one 18V LXT® 5.0Ah battery
- Holds (2) 18V LXT® Lithium-Ion batteries but operates using (1) 18V battery at a time; utilizes second battery when needed
- Makita-built BL™ Brushless Motor for optimal performance
- 2-speed with maximum speed up to 2.5 MPH on a 12° incline
- Reversible for versatility and convenience
- Interchangeable steel tube flat bed or steel bucket (steel bucket optional)

XUC01PTX2 Includes: 18V X2 LXT® Brushless Power-Assisted Hand Truck/Wheelbarrow (XUC01Z), (2) 18V LXT® Lithium-Ion 5.0Ah Battery (BL1850B), 18V LXT® Lithium-Ion Dual Port Charger (DC18RD), Flatbed Pipe Frame (199116-7), L-Shaped Legs, (2) Rear Wheel

XUC01X2 Includes: Tool only, battery & charger not included 18V X2 LXT® Brushless Power-Assisted Hand Truck/Wheelbarrow (XUC01Z), Flatbed Pipe Frame (199116-7), L-Shaped Legs, (2) Rear Wheel

Speed Forward (High/Low MPH)	2.5 / 1 MPH
Speed Reverse (MPH)	.62 MPH
Max. Load Capacity	275 lbs.
Max. Grade	12°
Battery	2X 18V LXT® Lithium-Ion
Dimensions (LxWxH)	43-3/4" x 26-3/8" x 32-1/4"
Net Weight	98.2 lbs.
Shipping Weight	136 lbs.

NEW CYCLONIC VACUUM ATTACHMENT
EASY DISPOSAL
FITS ALL 18V LXT® AND 12V CXT™ HAND VACUUMS



LXT CXT

199553-5
Cyclonic Vacuum Attachment

- Cyclonic action captures up to 90% of dust particles
- Reduces need to empty vacuum main canister/filter by up to 84%
- One-touch release for easy disposal of debris
- 360° positioning for access in tight spaces



LXT COMPACT

XLC02RB1W

XLC02ZW

18V LXT® Compact Vacuum Kit

- Up to 20 minutes of continuous run time with 2.0Ah Compact Lithium-Ion battery
 - Redesigned floor nozzle for improved maneuverability and debris collection
 - Strong suction power for fast and efficient cleaning
 - Bagless 2-stage cloth filtration system allows for easier cleaning and quicker debris disposal
 - Increased storage capacity for longer time between waste disposal
 - Compact and ergonomic design at only 18-3/4" long
- XLC02RB1W Includes:** 18V LXT® Compact Vacuum (XLC02ZW), 18V LXT® Lithium-Ion Compact 2.0Ah Battery (BL1820B), 18V LXT® Rapid Optimum Charger (DC18RC), Extension Attachment (451242-7), Floor Nozzle (122858-8), Crevice Nozzle (451240-7), Filter (451208-3), Cloth Vacuum Filter (443060-3)
- XLC02ZW Includes:** Tool only, battery & charger not included. Extension Attachment (451241-5), Floor Nozzle (122858-8), Crevice Nozzle (451240-7), Filter (451208-3), Cloth Vacuum Filter (443060-3)

Capacity (pint)	1.3 pint
Continuous Use (max, in minutes)	20 min.
Battery	18V LXT® Compact Lithium-Ion
Overall Length	18-3/4"
Net Weight (with battery)	2.7 lbs.
Shipping Weight	7.26 lbs.



LXT

XLC01ZB

18V LXT® Vacuum

- Up to 60 minutes of continuous use from a single fully charged 18V 5.0Ah LXT® battery (battery not included)
- Powerful motor generates 35 CFM of suction power
- Push button power selection for (high/low) operation
- Accepts disposable paper or cloth dust bags for easier cleaning
- Compact and ergonomic design at only 19" long
- Weighs only 2.9 lbs. with battery (battery not included) for reduced operator fatigue

XLC01ZB Includes: Tool only, battery & charger not included. Paper Filter, 5/pk (194566-1), Dust Bag (166084-9)

Capacity (pint)	1 pint
Continuous Use (max, in minutes)	60 min.
Battery	18V LXT® Lithium-Ion
Overall Length	19"
Net Weight (with battery)	2.9 lbs.
Shipping Weight	4.07 lbs.



LXT COMPACT

XLC02R1B

XLC02ZB

18V LXT® Compact Vacuum Kit

- Up to 13 minutes of continuous use from a single fully charged 18V Compact Lithium-Ion 2.0Ah battery
- Redesigned floor nozzle for improved maneuverability and debris collection
- Strong suction power for fast and efficient cleaning
- Bagless 2-stage cloth filtration system allows for easier cleaning and quicker debris disposal
- Increased storage capacity for longer time between waste disposal

XLC02R1B Includes: 18V LXT® Vacuum (XLC02ZB), 18V LXT® Lithium-Ion Compact 2.0Ah Battery (BL1820B), 18V LXT® Lithium-Ion Rapid Optimum Charger (DC18RC), Filter (451208-3), Cloth Vacuum Filter (443060-3), Floor Nozzle (123539-7), Crevice Nozzle Holder (456585-8), 6" Black Crevice Nozzle (456586-6), Extension Attachment (456587-4)

XLC02ZB Includes: Tool only, battery & charger not included. Filter (451208-3), Cloth Vacuum Filter (443060-3), Floor Nozzle (123539-7), Crevice Nozzle Holder (456585-8), 6" Black Crevice Nozzle (456586-6), Extension Attachment (456587-4)

Capacity (pint)	1.3 pint
Continuous Use (max, in minutes)	15 min.
Battery	18V LXT® Compact Lithium-Ion
Overall Length	18-3/4"
Net Weight (with battery)	2.7 lbs.
Shipping Weight	7.9 lbs.



5.0Ah BATTERY

LXT BRUSHLESS

DRC200PT

DRC200Z

18V X2 LXT® Brushless Robotic Vacuum Kit

- Cleans approximately 5,380 square feet of hard floor surfaces using two 18V LXT® 5.0Ah batteries BL1850B
- Up to 200 minutes of continuous operation on hard floors in "Main Brush plus Vacuum" mode using two 18V LXT® 5.0Ah batteries
- Efficient BL™ Brushless motor is electronically controlled to optimize battery energy use for up to 50% longer run time per charge
- Three stage cleaning system utilizes side brushes, main brush and vacuum suction to ensure complete cleaning performance

DRC200PT Includes: 18V X2 LXT® Brushless Robotic Vacuum (DRC200Z), (2) 18V LXT® Lithium-Ion 5.0Ah Batteries (BL1850B), 18V LXT® Lithium-Ion Dual Port Charger (DC18RD), Boundary Tape (SH00000240), High Efficiency Filter (SH00000213), Wireless Remote Control (SH00000238)

DRC200Z Includes: Tool only, battery & charger not included. Boundary Tape (SH00000240), High Efficiency Filter (SH00000213), Wireless Remote Control (SH00000238)

Gross Container Size	.66 gal.
Cleaning Width	8-7/8"
Cleaning Width (with side brushes)	18-1/16"
Working Sound Level	64 dB(A)
Continuous Use (max, in minutes)	200 min.
Battery	2X 18V LXT® Lithium-Ion
Dimensions (LxWxH)	18-1/8" x 18-1/8" x 7-1/8"
Net Weight (with battery)	17.2 lbs.
Shipping Weight	33 lbs.



LXT BRUSHLESS

DCL501Z

18V LXT® Brushless Cyclonic Canister Vacuum

- Powerful motor generates 46 CFM of suction power and 26.5" of water lift
- Up to 64 minutes of continuous operation using a 5.0Ah LXT® battery (battery not included)
- Efficient BL™ Brushless motor is electronically controlled to optimize battery energy use for up to 50% longer run time per charge
- The BL™ Brushless Motor eliminates carbon brushes, enabling the BL™ Motor to run cooler and more efficiently for longer life
- Cyclonic filtration system collects dust, separating the large debris particles in the dust cup and filtering micro particles through the HEPA filter

DCL501Z Includes: Tool only, battery & charger not included. Suction Hose (SH00000034), Floor Nozzle (SH00000058), Telescoping Extension Attachment (SH00000060), Crevice Nozzle (SH00000042), Shoulder Strap (166124-3)

Capacity (pint)	.53 pint
Air Flow Rate	46 CFM
Static Water Lift	26.5"
Continuous Use (max, in minutes)	64 min.
Battery	18V LXT® Lithium-Ion
Working Sound Level	64 dB(A)
Dimensions (LxWxH)	13-7/8" x 7-7/16" x 9-7/8"
Net Weight (with battery)	8.4 lbs.
Shipping Weight	9.9 lbs.



5.0Ah BATTERY

LXT BRUSHLESS

XCV11T

XCV11Z

18V LXT® Brushless 2 Gal. HEPA Filter Portable Wet/Dry Dust Extractor/Vacuum Kit

- Powerful BL™ Brushless motor delivers 57 CFM and 27" water lift of suction using an 18V LXT® Lithium-Ion battery
- Filter cleaning system is designed to maintain optimum suction efficiency and longer filter life
- Efficient HEPA filter captures 99.97% of particulates .3 microns and larger
- Up to 60 minutes of continuous run time using an 18V LXT® Lithium-Ion 5.0Ah battery BL1850B
- Compact and portable design with shoulder strap; weighs only 10.1 lbs. with 18V LXT® battery (shoulder strap not included)

XCV11T Includes: 18V LXT® Lithium-Ion Rapid Optimum Charger (DC18RC), 18V LXT® Lithium-Ion 5.0Ah Battery (BL1850B), Round Wet/Dry HEPA Filter (162518-0), Pre-Filter Set, XCV11Z (199827-4), 5" Black Upholstery Nozzle (458891-7), 7" Black Crevice Nozzle (458919-1), Anti-Static Flexible Hose, 1" x 6.5' (140G04-3)

XCV11Z Includes: Tool only, battery & charger not included. Round Wet/Dry HEPA Filter (162518-0), Pre-Filter Set, XCV11Z (199827-4), 5" Black Upholstery Nozzle (458891-7), 7" Black Crevice Nozzle (458919-1), Anti-Static Flexible Hose, 1" x 6.5' (140G04-3)

Gross Container Size	2 gal.
Air Flow Rate	57 CFM
Static Water Lift	27"
Continuous Use (max, in minutes)	60 min.
Battery	18V LXT® Lithium-Ion
Filter Cleaning	Yes
HEPA filter	Yes
Equipped Filter Efficiency	99.97% of .3 microns
Working Sound Level	76 dB(A)
Net Weight (with battery)	10.1 lbs.



LXT

XCV02Z

18V LXT® 3/4 Gallon Portable Dry Dust Extractor/Blower

- Makita-built motor delivers 49 CFM and 24" water lift of suction using an 18V LXT® Lithium-Ion battery (battery not included)
- Up to 42 minutes of continuous operation using a fully charged 18V 5.0Ah LXT® battery (battery not included)
- Two tools in one; quickly converts from dust extractor to a blower by attaching blower nozzle for added versatility
- Portable design with shoulder strap; weighs only 5.3 lbs. with 18V LXT® battery (battery not included)
- Dust cloth bag with 3/4 gallon capacity for maximum debris extraction easily detaches to discard collected material

XCV02Z Includes: Tool only, battery & charger not included. Anti-Static Hose, 1" x 8.2' (140456-6), Dust Bag (122918-6), Rubber Blower Nozzle (132025-7), Shoulder Strap (166094-6), Tool Cuff Adapter, 38mm for 1" hose (417766-9), Tool Cuff Adapter, 22mm for 1" hose (417765-1)

Gross Container Size	.75 gal.
Air Flow Rate	49 CFM
Static Water Lift	24"
Continuous Use (max, in minutes)	42 min.
Battery	18V LXT® Lithium-Ion
Working Sound Level	84 dB(A)
Dust Blower	Yes
Max. Air Velocity	210 MPH
Dimensions (LxWxH)	15-7/8" x 7-5/8" x 8-7/8"
Net Weight (with battery)	5.3 lbs.
Shipping Weight	7.94 lbs.



LXT BRUSHLESS **AWS**

NEW XCV08PT XCV08Z

18V X2 LXT® (36V) Brushless 2.1 Gal HEPA Filter Dry Dust Extractor/Vac Kit, AWS™

- Powerful BL™ Brushless motor delivers 74 CFM and 39" water lift of suction using two 18V LXT® Lithium-Ion batteries
- Efficient three stage HEPA filtration system captures 99.97% of particulates .3 microns and larger
- Filter cleaning system is designed to maintain optimal suction efficiency and longer filter life

XCV08PT Includes: 18V X2 LXT® (36V) Brushless 2.1 Gal. HEPA Filter Dry Dust Extractor/Vacuum, AWS™ (XCV08Z), (2) 18V LXT® Lithium-Ion 5.0Ah Battery (BL1850B), 18V LXT® Lithium-Ion Dual Port Charger (DC18RD), Anti-Static Hose, 1-1/2" x 8' (195434-1), Curved Tube (192562-3), Straight Tube (192563-1), Floor Nozzle (122512-4), Crevice Nozzle (410306-2), Anti-Static Hose, 1" x 11' (195433-3), Tool Cuff Adapter, 22mm for 1" hose (417765-1), Tool Cuff Adapter, 24mm for 1" hose (424379-9), Tool Cuff Adapter, 38mm for 1" hose (417766-9), Plastic Disposal Bag, 10/pk (195432-5), HEPA Filter (197166-6), Damper Filter (423398-2), Pre-Filter (195553-3)

XCV08Z Includes: Same as XCV08PT except does not include battery & charger

Gross Container Size	2.1 gal.
Air Flow Rate	74 CFM
Static Water Lift	39"
Continuous Use (max, in minutes)	75 min.
Battery	2X 18V LXT® Lithium-Ion
HEPA filter	Yes
Equipped Filter Efficiency	99.97% of .3 microns
Automatic-start Wireless System (AWS™)	Yes
Working Sound Level	66 dB(A)
Net Weight (with battery)	18.4 lbs.
Shipping Weight	35.94 lbs.



LXT BRUSHLESS

NEW XCV07PTX XCV07ZX

18V X2 LXT® (36V) Brushless 2.1 Gallon HEPA Filter Dry Dust Extractor Kit

- Powerful Makita BL™ Brushless motor delivers 74 CFM and 39" water lift of suction using two 18V LXT® Lithium-Ion batteries
- Efficient three stage HEPA filtration system captures 99.97% of particulates .3 microns and larger
- Up to 75 minutes of run time on low setting and 40 minutes on high setting using two 18V LXT® 5.0Ah batteries

XCV07PTX Includes: 18V X2 LXT® (36V) Brushless 2.1 Gallon HEPA Filter Dry Dust Extractor (XCV07ZX), (2) 18V LXT® Lithium-Ion 5.0Ah Battery (BL1850B), 18V LXT® Lithium-Ion Dual Port Charger (DC18RD), Anti-Static Hose, 1" x 11' (195433-3), Tool Cuff Adapter, 22mm for 1" hose (417765-1), Tool Cuff Adapter, 24mm for 1" hose (424379-9), Tool Cuff Adapter, 38mm for 1" hose (417766-9), Plastic Disposal Bag, 10/pk (195432-5), HEPA Filter (197166-6), Damper Filter (423398-2), Pre-Filter (195553-3)

XCV07ZX Includes: Same as XCV07PTX except does not include battery & charger

Gross Container Size	2.1 gal.
Air Flow Rate	74 CFM
Static Water Lift	39"
Continuous Use (max, in minutes)	75 min.
Battery	2X 18V LXT® Lithium-Ion
Filter Cleaning	Yes
HEPA filter	Yes
Equipped Filter Efficiency	99.97% of .3 microns
Working Sound Level	66 dB(A)
Net Weight (with battery)	18.4 lbs.
Shipping Weight	31.97 lbs.



LXT X2 18V + 18V 36V

XCV04Z

18V X2 LXT® (36V) 2.1 Gallon HEPA Filter Dry Dust Extractor/Vacuum

- Powerful Makita-built motor delivers 127 CFM and 96" water lift of suction using corded power
- Powerful Makita-built motor delivers 74 CFM and 36" water lift of suction using two 18V LXT® Lithium-Ion batteries (batteries not included)
- Efficient three stage HEPA filtration system captures 99.97% of particulates .3 microns and larger extending the life of the main filter
- Filter cleaning system is designed to maintain optimum suction efficiency and longer filter life

XCV04Z Includes: Tool only, battery & charger not included. Anti-Static Hose, 1-1/2" x 8' (195434-1), Curved Tube (192562-3), Straight Tube (192563-1), Crevice Nozzle (410306-2), Floor Nozzle (122512-4), Anti-Static Hose, 1" x 11' (195433-3), Tool Cuff Adapter, 24mm for 1" hose (424379-9), Tool Cuff Adapter, 22mm for 1" hose (417765-1), Tool Cuff Adapter, 38mm for 1" hose (417766-9), Plastic Disposal Bag, 10/pk (195432-5), HEPA Filter (197166-6), Damper Filter (423398-2), Pre-Filter (195553-3)

Gross Container Size	2.1 gal.
Air Flow Rate	127 CFM
Static Water Lift	96"
Continuous Use (max, in minutes)	65 min.
Battery	2X 18V LXT® Lithium-Ion
AMPS	9.2
Filter Cleaning	Yes
HEPA filter	Yes
Equipped Filter Efficiency	99.97% of .3 microns
Working Sound Level	64 dB(A)
Net Weight (with battery)	21.8 lbs.
Shipping Weight	33.3 lbs.



LXT BRUSHLESS

XCV06Z

18V X2 LXT® (36V) Brushless 2.1 Gallon Wet/Dry Dust Extractor/Vacuum

- Powerful Makita BL™ Brushless motor delivers 74 CFM using two 18V LXT® Lithium-Ion batteries (batteries not included)
- Up to 75 minutes of continuous run time on low setting and 40 minutes on high setting using two 18V LXT® 5.0Ah batteries (batteries not included)
- Efficient BL™ Brushless motor is electronically controlled to optimize battery energy use for up to 50% longer run time per charge
- Oversized on-off switch for operator convenience
- Motor chamber constructed of quality sound-absorbing materials for quiet operating sound levels of 66 dB(A)

XCV06Z Includes: Tool only, battery & charger not included. Anti-Static Hose, 1-1/2" x 8' (195434-1), Curved Tube (192562-3), Straight Tube (192563-1), Floor Nozzle (122512-4), Crevice Nozzle (410306-2), Plastic Disposal Bag, 10/pk (195432-5), Cloth Vacuum Filter (140248-3)

Gross Container Size	2.1 gal.
Wet Capacity	1.5 gal.
Air Flow Rate	74 CFM
Static Water Lift	39"
Continuous Use (max, in minutes)	75 min.
Battery	2X 18V LXT® Lithium-Ion
Filter Cleaning	No
HEPA filter	No
Working Sound Level	66 dB(A)
Net Weight (with battery)	16.8 lbs.
Shipping Weight	25.3 lbs.



LXT BRUSHLESS

NEW XCV09PT XCV09Z

18V X2 LXT® (36V) Brushless 1/2 Gallon HEPA Filter Backpack Dry Vacuum Kit

- Powerful BL™ Brushless Motor generates 70 CFM of suction power and 44" of water lift
- Up to 116 minutes of continuous operation on normal setting using two 18V LXT® 5.0Ah batteries
- Efficient two stage HEPA filter captures 99.97% of particulates .3 microns and larger extending the life of the main filter

XCV09PT Includes: 18V X2 LXT® (36V) Brushless 1/2 Gallon HEPA Filter Backpack Dry Vacuum (XCV09Z), (2) 18V LXT® Lithium-Ion 5.0Ah Battery (BL1850B), 18V LXT® Lithium-Ion Dual Port Charger (DC18RD), Flexible Anti-Static Hose, 1" x 39" (143787-2), HEPA Filter (123636-9), Crevice Nozzle (197900-4), Floor Nozzle (127082-8), Bent Pipe (127093-3), Aluminum Telescoping Extension Wand (140619-0), Harness (162469-7), Sleeve (456744-4), Filter Dust Bag

XCV09Z Includes: Tool only, battery & charger not included. Flexible Anti-Static Hose, 1" x 39" (143787-2), HEPA Filter (123636-9), Crevice Nozzle (197900-4), Sleeve (456744-4), Floor Nozzle (127082-8), Bent Pipe (127093-3), Aluminum Telescoping Extension Wand (140619-0), Harness (162469-7), Filter Dust Bag

Gross Container Size	.5 gal.
Air Flow Rate	70 CFM
Static Water Lift	44"
Continuous Use (max, in minutes)	116 min.
Battery	2X 18V LXT® Lithium-Ion
HEPA filter	Yes
Equipped Filter Efficiency	99.97% of .3 microns
Working Sound Level	69 dB(A)
Dimensions (LxWxH)	7-1/4" x 9" x 14-3/4"
Net Weight (with battery)	9.9 lbs.
Shipping Weight	20.15 lbs.



LXT BRUSHLESS

XCV05PT XCV05Z

18V X2 LXT® (36V) Brushless Backpack Dust Extractor/Vacuum Kit

- Powerful BL™ Brushless Motor generates 53 CFM of suction power and 28.5" of water lift
- Up to 90 minutes of continuous operation on low setting and 60 minutes on high setting using two 18V LXT® 5.0Ah batteries
- Efficient two stage HEPA filtration system captures 99.97% of particulates .3 microns and larger extending the life of the main filter

XCV05PT Includes: (2) 18V LXT® Lithium-Ion 5.0Ah Battery (BL1850B), 18V LXT® Lithium-Ion Dual Port Charger (DC18RD), Floor Nozzle (123486-2), Telescoping Extension Attachment (123584-2), Flexible Anti-Static Hose, 1" x 39" (143787-2), Harness (161479-1), Bent Pipe (12367-5), Crevice Nozzle (197900-4), Hose Band (166116-2), HEPA Filter (123636-9), Sleeve (456744-4), Filter Dust Bag

XCV05Z Includes: Tool only, battery & charger not included. Floor Nozzle (123486-2), Telescoping Extension Attachment (123584-2), Flexible Anti-Static Hose, 1" x 39" (143787-2), Harness (161479-1), Bent Pipe (12367-5), Crevice Nozzle (197900-4), Hose Band (166116-2), HEPA Filter (123636-9), Sleeve (456744-4), Filter Dust Bag

Gross Container Size	.5 gal.
Air Flow Rate	53 CFM
Static Water Lift	28.5"
Continuous Use (max, in minutes)	90 min.
Battery	2X 18V LXT® Lithium-Ion
HEPA filter	Yes
Equipped Filter Efficiency	99.97% of .3 microns
Working Sound Level	70 dB(A)
Dimensions (LxWxH)	7-1/4" x 9" x 14-3/4"
Net Weight (with battery)	9.4 lbs.
Shipping Weight	19.51 lbs.



LXT BRUSHLESS

XCV05ZX

18V X2 LXT® (36V) Brushless Backpack Dust Extractor/Vacuum

- Powerful BL™ Brushless Motor generates 53 CFM of suction power and 28.5" of water lift
- Up to 90 minutes of continuous operation on low setting and 60 minutes on high setting using two 18V LXT® 5.0Ah batteries (batteries not included)
- Efficient two stage HEPA filtration system captures large, small and micro dust particulates extending the life of the main HEPA filter
- Efficient BL™ Brushless Motor is electronically controlled to optimize battery energy use for up to 50% longer run time per charge

XCV05ZX Includes: Tool only, battery & charger not included. 18V X2 LXT® (36V) Brushless Backpack Dust Extractor/Vacuum (XCV05Z), Tool Cuff Adapter, 22mm for 1" hose (417765-1), Tool Cuff Adapter, 24mm for 1" hose (424379-9), Tool Cuff Adapter, 38mm for 1" hose (417766-9), HEPA Filter (123636-9), Harness (161479-1), Flexible Hose, 1" x 59" (152992-0), Filter Dust Bag

Gross Container Size	.5 gal.
Air Flow Rate	53 CFM
Static Water Lift	28.5"
Continuous Use (max, in minutes)	60 min.
Battery	2X 18V LXT® Lithium-Ion
HEPA filter	Yes
Equipped Filter Efficiency	99.97% of .3 microns
Working Sound Level	70 dB(A)
Dimensions (LxWxH)	7-1/4" x 9" x 14-3/4"
Net Weight (with battery)	9.4 lbs.
Shipping Weight	9.5 lbs.



LXT BRUSHLESS **AWS**

NEW XCV10ZX

18V X2 LXT® (36V) BL™ 1/2 Gal. HEPA Filter Backpack Dust Extractor, AWS™ Capable

- Powerful BL™ Brushless Motor generates 64 CFM of suction power and 44" of water lift
- Up to 62 minutes of continuous operation on normal setting and 33 minutes on high setting using two 18V LXT® 5.0Ah batteries (batteries not included)
- Efficient two stage HEPA filter captures 99.97% of particulates .3 microns and larger extending the life of the main filter
- Auto-start Wireless System (AWS™) utilizes Bluetooth® technology for wireless power-on/off communication between tool and dust extractor
- Includes the 3 tool adapters for hose connection to most Makita dust extraction attachments

XCV10ZX Includes: Tool only, battery & charger not included. Flexible Hose, 1" x 59" (152992-0), HEPA Filter (123636-9), Tool Cuff Adapter, 22mm for 1" hose (417765-1), Tool Cuff Adapter, 24mm for 1" hose (424379-9), Tool Cuff Adapter, 38mm for 1" hose (417766-9), Harness (162469-7), Filter Dust Bag

Gross Container Size	.5 gal.
Air Flow Rate	64 CFM
Static Water Lift	44"
Continuous Use (max, in minutes)	62 min.
Battery	2X 18V LXT® Lithium-Ion
HEPA filter	Yes
Equipped Filter Efficiency	99.97% of .3 microns
Automatic-start Wireless System (AWS™)	Capable (transmitter sold separately)
Working Sound Level	69 dB(A)
Dimensions (LxWxH)	7-1/4" x 9" x 14-3/4"
Net Weight (with battery)	10 lbs.
Shipping Weight	10.01 lbs.



LXT

DCF300Z

18V LXT® 13" Job Site Fan

- Durable design engineered to withstand a job site environment
- Frame structure engineered to reduce wind noise
- Three settings (high/medium/low) and oscillation selector for optimal air velocity and control
- 3-stage automatic timer with 1, 2, and 4 hour power-off selection
- Removable front guard for convenient clean up
- Tilt up/down design make it convenient to redirect air flow

DCF300Z Includes: Tool only, battery & charger not included
AC Adapter (TE00000110)

Voltage	18V
AC Adapter	Yes
Run Time (max. in hours)	5.7
Speed Settings	3
Battery	18V LXT® Lithium-Ion
Dimensions (LxWxH)	12-1/2" x 18-9/10" x 23-7/10"
Net Weight (with battery)	10.4 lbs.
Shipping Weight	12.6 lbs.



LXT

DCF201Z

18V LXT® Job Site Fan

- Durable design engineered to withstand a job site environment
- Protective bumpers for increased durability
- Two settings (high 1,700 RPM, low 1,200 RPM) for optimal air velocity control
- 3-stage automatic timer with 1, 2, and 4 hour power-off selection
- Large carrying handle for easy handling
- 45° adjustable platform allows a full range of fan positions

DCF201Z Includes: Tool only, battery & charger not included
AC Adapter

Voltage	18V
AC Adapter	Yes
Run Time (max. in hours)	5.5
Speed Settings	2
Battery	18V LXT® Lithium-Ion
Dimensions (LxWxH)	5" x 13-3/5" x 21-1/10"
Net Weight (with battery)	5.7 lbs.
Shipping Weight	6.76 lbs.



LXT

NEW DCF102Z

18V LXT® 7-1/8" Fan

- Three speed settings (High/Medium/Low) and Oscillation selector for optimal air velocity and control
- Designed for reduced wind noise level for quiet operation
- Automatically oscillates 45° right and left
- Manually tilts 90° up and 45° down for convenient redirection of airflow
- 3-stage automatic timer with 1, 2, and 4 hour power-off selection
- Adjustable hook for easy handling and hanging

DCF102Z Includes: Tool only, battery & charger not included

Voltage	18V
AC Adapter	Yes
Run Time (max. in hours)	21
Speed Settings	3
Battery	18V LXT® Lithium-Ion
Dimensions (LxWxH)	5-7/8" x 10-5/8" x 19-3/8"
Fan Settings	High-Medium-Low
Shipping Weight	4.65 lbs.



LXT CXT

Bluetooth

XRM06B

18V LXT® / 12V max CXT® Bluetooth® Job Site Radio

- Equipped with Bluetooth® to wirelessly connect your mobile device to play music
- Menu controls to set FM mono/stereo, clock settings, volume and snooze
- Runs up to 35 hours with an 18V LXT® Lithium-Ion 5.0Ah battery and 14 hours with an 18V Compact Lithium-Ion 2.0Ah battery (battery not included)
- Compatible with 7.2V, 12V max, 12V max CXT®, 14.4V, and 18V LXT® Lithium-Ion batteries
- Protective bumpers are engineered for increased durability
- One auxiliary port for MP3 compatibility and one USB port for charging your mobile device

XRM06B Includes: Tool only, battery & charger not included

Voltage	7.2-18V
Digital Tuner	FM/AM
Auxiliary Port	Yes
Bluetooth®	Yes
MP3 Compatible	Yes
AC Adapter	Yes
Backlit LCD Display	Yes
Dimensions (LxWxH)	10-3/8" x 6-3/8" x 11-5/8"
Net Weight (with battery)	10.8 lbs.
Shipping Weight	11.5 lbs.



LXT CXT

Bluetooth

XRM08B

18V LXT® / 12V max CXT™ Bluetooth® Job Site Speaker

- Equipped with Bluetooth® to wirelessly connect your mobile device to play music a distance up to 33 ft.
- Speaker is operated by menu controls located on the front of the unit
- Up to 32 hours of continuous operation in auxiliary mode and 31 hours with Bluetooth function enabled*
- Protective bumpers are engineered for increased durability
- One auxiliary port for MP3 compatibility, one USB port for charging your mobile device and AC adapter jack for powering speaker
- Delivers rich sound; woofer for low sounds and tweeter for high sounds

XRM08B Includes: Tool only, battery & charger not included
AC Adapter

Voltage	12-18V
USB Power Port	1
Auxiliary Port	Yes
Bluetooth®	Yes
MP3 Compatible	Yes
AC Adapter	Yes
Dimensions (LxWxH)	8-5/16" x 8" x 7-7/8"
Net Weight (with battery)	7.2 lbs.
Shipping Weight	7.5 lbs.

*using battery BL1850B



XRM05W shown

LXT

NEW XRM05W / XRM05

18V LXT® Job Site Radio

- Delivers rich stereo sound from two powerful 3" side-firing speakers
- Up to 35 hours of continuous use with 18V LXT® Lithium-Ion 5.0Ah battery (battery not included)
- Compatible with 7.2V, 12V max, 12V max CXT®, 14.4V, and 18V LXT® Lithium-Ion batteries
- Protective bumper design for added durability
- 5 Preset FM/AM buttons
- One auxiliary port for MP3 compatibility

XRM05W Includes: AC ADAPTER (SE0000104), (2) AA Battery for Clock

XRM05 Includes: AC ADAPTER (SE0000104), (2) AA Battery for Clock

Voltage	7.2-18V
Shipping Weight	10.8 lbs.
Digital Tuner	FM/AM
Auxiliary Port	Yes
Bluetooth®	No
MP3 Compatible	Yes
AC Adapter	Yes
Backlit LCD Display	Yes
Dimensions (LxWxH)	10-1/8" x 6-3/8" x 17"
Net Weight (with battery)	10.1 lbs.



LXT

DCM500Z

18V LXT® Cordless/Corded Coffee Maker

- Brews one 5 oz. cup of coffee in 3 min. when plugged into a power outlet; one 5 oz. cup of coffee in 7 min. when powered by a 5.0Ah 18V LXT® battery
- No paper filters needed; permanent drip filter allows grounds to be poured directly into coffee maker
- Battery adapter can be removed when using AC power
- Compact design at only 8-3/8" tall with a 3-1/2" cup clearance
- Boil dry protection automatically turns the coffee maker off if there is not enough water
- Weighs only 3.7 lbs. with battery (battery not included)

DCM500Z Includes: Tool only, battery & charger not included
Measuring Spoon, AC Power Supply Cord, Battery Holder

Battery	18V LXT® Lithium-Ion
Dimensions (LxWxH)	8-3/4" x 4-1/2" x 8-3/8"
Net Weight (with battery)	3.7 lbs.
Shipping Weight	4.4 lbs.



LXT

DML805

18V LXT® Cordless/Corded L.E.D. Flood Light

- Up to 8.5 hours of continuous illumination with a 5.0Ah 18V LXT® battery on High mode (battery and charger not included)
- Up to 17 hours of continuous illumination with a 5.0Ah 18V LXT® battery on Low mode (battery and charger not included)
- L.E.D. flood light delivers either full brightness (750 lumens) on High or half brightness (450 lumens) on Low
- Extreme Protection Technology (XPT™) is engineered for improved dust and water resistance for operation in harsh conditions (only with DC power)
- L.E.D. lights effectively illuminate work area without the high heat of Halogens
- Adjusting knobs enable the user to direct the flood light to desired angle

DML805 Includes: Light only, battery & charger not included

Run Time (max. in hours)	17
Battery	18V LXT® Lithium-Ion
Lumens	750
Bulb	20 LED
Overall Length	8-3/8"
Net Weight (with battery)	6.1 lbs.
Shipping Weight	6.1 lbs.



LXT

DML800

18V LXT® L.E.D. Headlamp

- High-luminance 1.6W single L.E.D. bulb provides 100 lumens
- Lamp Head adjusts 0° - 90° with 7 positive stops
- Lamp Head features a IPX-4 water-resistant design
- Non-slip rubber strap keeps the lamp head securely attached to hard hats
- Can also be used as a stationary light by attaching the lamp head to the battery holder
- Battery holder features a built-in clip for attaching to belt

DML800 Includes: Headlamp only, battery & charger not included

Run Time (max. in hours)	33
Battery	18V LXT® Lithium-Ion
Lumens	100
Bulb	1 LED
Overall Length	2-13/16"
Net Weight (with battery)	1.7 lbs.
Shipping Weight	.595 lbs.



LXT

DML802

18V LXT® L.E.D. Flashlight

- High-luminance single L.E.D. flashlight provides 160 lumens
- 12 position pivoting flashlight head with positive stops from 60° - 110°
- Aluminum flashlight head design for increased durability
- Metal hang hook is convenient and job site durable
- Compact and ergonomic design at only 10-3/4" long
- Only use genuine Makita batteries and chargers

DML802 Includes: Flashlight only, battery & charger not included

Run Time (max. in hours)	23
Battery	18V LXT® Lithium-Ion
Lumens	160
Bulb	1 LED
Overall Length	10-3/4"
Net Weight (with battery)	2.1 lbs.
Shipping Weight	2.1 lbs.



LXT

DML185

18V LXT® Xenon Flashlight

- High-luminance single xenon bulb provides 180 lumens
- Up to 7.5 hours of illumination with 5.0Ah LXT® battery (battery not included)
- 4-position head pivots for versatility
- Compact and ergonomic design at only 11-1/8" long
- Durable design for job site use
- Includes shoulder strap and 2 bulbs; replacement bulb stores in flashlight head for convenience

DML185 Includes: Flashlight only, battery & charger not included (2) Replacement Bulb (Xenon), 2/pk (A-90261)

Run Time (max. in hours)	7.5
Battery	18V LXT® Lithium-Ion
Lumens	180
Bulb	Xenon
Overall Length	11-1/8"
Net Weight (with battery)	2.1 lbs.
Shipping Weight	1.2 lbs.



LXT

DML808

18V LXT® Adjustable Beam L.E.D. Flashlight

- High-luminance single L.E.D. flashlight provides 200 lumens
- Beam adjustment from spot to flood by simply rotating the focusing ring
- 12 position pivoting flashlight head with positive stops from 60° - 110°
- Aluminum flashlight head design for increased durability
- Metal hang hook is convenient and job site durable
- Compact and ergonomic design at only 11-3/4" long

DML808 Includes: Flashlight only, battery & charger not included

Run Time (max. in hours)	23
Battery	18V LXT® Lithium-Ion
Lumens	200
Bulb	1 LED
Overall Length	11-3/4"
Net Weight (with battery)	2.5 lbs.
Shipping Weight	1.06 lbs.



LXT

LXLM01

18V LXT® L.E.D. Flashlight

- 6 LED Flashlight runs up to 82.5 hours per charge from a single fully charged 18V 5.0Ah LXT® Lithium-Ion battery (battery not included)
- Compact and ergonomic design at 5-7/8" long
- Weighs only 1.3 lbs. with battery (battery not included) for reduced operator fatigue
- Hand strap for extra convenience
- Compact size ideal for work in tight spaces
- Ideal addition to any tool box

LXLM01 Includes: Flashlight only, battery & charger not included

Run Time (max. in hours)	82.5
Battery	18V LXT® Lithium-Ion
Lumens	500
Bulb	6 LED
Overall Length	5-7/8"
Net Weight (with battery)	1.3 lbs.
Shipping Weight	.5 lbs.



LXT

DML801

18V LXT® L.E.D. Flashlight

- Up to 17 hours of continuous illumination in 12 L.E.D. mode with a 5.0Ah 18V LXT® battery (sold separately)
- Up to 40 hours of continuous illumination in 6 L.E.D. mode with a 5.0Ah 18V LXT® battery (sold separately)
- Flashlight head folds up and down with 7 positive stops and rotates left to right for multiple lighting angles
- Metal hang hook swivels 360° and folds away for extra convenience
- 2-mode on/off switch delivers either full brightness (240 lumens) with 12 L.E.D. or half brightness (120 lumens) with 6 L.E.D.
- Compact and ergonomic design at only 15" long

DML801 Includes: Flashlight only, battery & charger not included

Run Time (max. in hours)	40
Battery	18V LXT® Lithium-Ion
Lumens	240
Bulb	12 LED
Overall Length	15"
Net Weight (with battery)	2.1 lbs.
Shipping Weight	2.1 lbs.



LXT

DML806

18V LXT® L.E.D. Lantern/Flashlight

- Three L.E.D. lighting modes: 360° lantern, 180° lantern or flashlight
- 360° lantern mode provides 620 lumens; 180° lantern mode provides 310 lumens; flashlight mode provides 90 lumens
- 180°-360° lantern lighting allows the user to select between entire work area or specific task illumination
- Up to 11 hours of continuous illumination in 360° lantern mode with a 5.0Ah LXT® battery (battery sold separately)
- Up to 21 hours of continuous illumination in 180° lantern mode with a 5.0Ah LXT® battery (battery sold separately)
- Up to 59 hours of continuous illumination in flashlight mode with a 5.0Ah LXT® battery (battery sold separately)

DML806 Includes: Flashlight only, battery & charger not included

Run Time (max. in hours)	59
Battery	18V LXT® Lithium-Ion
Lumens	240
Bulb	12 LED
Overall Length	14-3/8"
Net Weight (with battery)	2.1 lbs.
Shipping Weight	1.4 lbs.



LXT

DML807

18V LXT® L.E.D. Lantern/Flashlight

- Three L.E.D. lighting modes: 360° lantern, 180° lantern or flashlight
- 360° lantern mode provides 610 lumens; 180° lantern mode provides 300 lumens; flashlight mode provides 150 lumens
- 180°-360° lantern lighting allows the user to select between entire work area or specific task illumination
- Up to 11 hours of continuous illumination in 360° lantern mode with a 5.0Ah LXT® battery (battery sold separately)
- Up to 23 hours of continuous illumination in 180° lantern mode with a 5.0Ah LXT® battery (battery sold separately)
- Up to 36 hours of continuous illumination in flashlight mode with a 5.0Ah LXT® battery (battery sold separately)

DML807 Includes: Flashlight only, battery & charger not included

Run Time (max. in hours)	36
Battery	18V LXT® Lithium-Ion
Lumens	300
Bulb	12 LED
Overall Length	14-1/4"
Net Weight (with battery)	2.2 lbs.
Shipping Weight	1.36 lbs.

STAY WARM IN COLD, HARSH JOB SITE ENVIRONMENTS

RUN TIME

Power source accepts Makita 18V LXT® and Compact Lithium-Ion Batteries and features a USB power port for charging portable electronic devices



Battery not included

DESIGN

3 heat settings (high/medium/low) for precise heating control



DCJ206Z shown

CONVENIENCE

On/Off heat controller with L.E.D. indicators



DCJ201Z shown

STAY COOL IN HOT JOB SITE ENVIRONMENTS

CONTROL

3 air flow modes (high/medium/low) plus turbo mode for optimum air circulation



DFJ405Z shown

EFFICIENCY

Two recessed fan units located on left and right side provide optimum airflow and comfort



DFJ304Z shown



NEW DCJ205Z

18V LXT® Heated Jacket

- Up to 35 hours of run time on low setting with 18V LXT® 6.0Ah battery (battery sold separately)
- Polyester shell for increased wind and water resistance
- Stretchy side panels for increased mobility
- Fleece interior for added warmth and comfort
- 5 core heat zones (left chest, right chest, back and both pockets) for optimum heat distribution

DCJ205Z Includes: Jacket only, battery & charger not included

Model	Size	Model	Size
DCJ205ZS	Small	DCJ205ZXL	X-Large
DCJ205ZM	Medium	DCJ205Z2XL	2X-Large
DCJ205ZL	Large	DCJ205Z3XL	3X-Large

Available Sizes:	Small, Medium, Large, X-Large, 2X-Large, 3X-Large
Heat Settings	High-Medium-Low
Battery	18V LXT® Lithium-Ion
Number of Pockets	5 (including battery pocket)
USB Power Port	1
Net Weight (with battery)	3.8 lbs.
Shipping Weight	4.46 lbs.



NEW DCJ206Z

18V LXT® High Visibility Heated Jacket

- Meets ANSI107 Class 3 requirements for use in work environments
- Up to 37.5 hours of run time on low setting with 18V LXT® 6.0Ah battery (battery sold separately)
- Fluorescent color with silver reflective tape accents provide increased visibility in low light
- Polyester shell for increased wind and water resistance

DCJ206Z Includes: Jacket only, battery & charger not included

Model	Size	Model	Size
DCJ206ZS	Small	DCJ206ZXL	X-Large
DCJ206ZM	Medium	DCJ206Z2XL	2X-Large
DCJ206ZL	Large	DCJ206Z3XL	3X-Large

Available Sizes:	Small, Medium, Large, X-Large, 2X-Large, 3X-Large
Heat Settings	High-Medium-Low
Battery	18V LXT® Lithium-Ion
Number of Pockets	5 (including battery pocket)
USB Power Port	1
Net Weight (with battery)	3.8 lbs.
Shipping Weight	4.69 lbs.



DCJ201Z

18V LXT® Mossy Oak® Heated Jacket

- 3 core heat zones (left chest, right chest, back) for optimum heat distribution
- 3 heat settings (high/medium/low) for precise heating control
- Features 4 pockets: zippered chest pocket and side pockets (left and right), sleeve pocket
- On/Off heat controller with 3 L.E.D. indicators
- Battery pocket on rear left side for quick and easy access

DCJ201Z Includes: Jacket only, battery & charger not included (PE0000017)

Model	Size	Model	Size
DCJ201ZS	Small	DCJ201ZXL	X-Large
DCJ201ZM	Medium	DCJ201Z2XL	2X-Large
DCJ201ZL	Large	DCJ201Z3XL	3X-Large

Available Sizes:	Small, Medium, Large, X-Large, 2X-Large, 3X-Large
Heat Settings	High-Medium-Low
Battery	18V LXT® Lithium-Ion
Number of Pockets	5 (including battery pocket)
USB Power Port	1
Zip-off Sleeves	Yes
Net Weight (with battery)	3.8 lbs.
Shipping Weight	3.8 lbs.



NEW DFJ405Z

18V LXT® UV Resistant Fan Jacket

- 3 air flow modes (high/medium/low) with L.E.D. indicators plus turbo mode for optimum air circulation and effective cooling
- Up to 15 hours of run time on high setting with 18V LXT® 5.0Ah battery (battery sold separately)
- Features 5 pockets: (2) zippered chest pockets, side pockets (left and right) and sleeve pocket

DFJ405Z Includes: Jacket only, battery & charger not included 18V LXT® Power Source w/ USB port (198631-8)

Model	Size	Model	Size
DFJ405ZS	Small	DFJ405ZXL	X-Large
DFJ405ZM	Medium	DFJ405Z2XL	2X-Large
DFJ405ZL	Large	DFJ405Z3XL	3X-Large

Available Sizes:	Small, Medium, Large, X-Large, 2X-Large, 3X-Large
Fan Settings	High-Medium-Low
USB Power Port	1
Number of Pockets	5 (including battery pocket)
Battery	18V LXT® Lithium-Ion
Net Weight (with battery)	3.3 lbs.
Shipping Weight	2.65 lbs.



NEW DFJ304Z

18V LXT® Cotton Fan Jacket

- 3 air flow modes (high/medium/low) with L.E.D. indicators plus turbo mode for optimum air circulation and effective cooling
- Up to 15 hours of run time on high setting with 18V LXT® 5.0Ah battery (battery sold separately)
- Features 5 pockets: (2) zippered chest pockets, side pockets (left and right) and sleeve pocket

DFJ304Z Includes: Jacket only, battery & charger not included 18V LXT® Power Source w/ USB port (198631-8)

Model	Size	Model	Size
DFJ304ZS	Small	DFJ304ZXL	X-Large
DFJ304ZM	Medium	DFJ304Z2XL	2X-Large
DFJ304ZL	Large	DFJ304Z3XL	3X-Large

Available Sizes:	Small, Medium, Large, X-Large, 2X-Large, 3X-Large
Fan Settings	High-Medium-Low
USB Power Port	1
Number of Pockets	5 (including battery pocket)
Battery	18V LXT® Lithium-Ion
Net Weight (with battery)	3.3 lbs.
Shipping Weight	2.65 lbs.



DCV200Z

18V LXT® Heated Vest

- Up to 28 hours of heat using 5.0Ah LXT® battery on low setting (battery not included)
- 2 core heat zones (shoulders & back) provide optimum heat distribution
- 3 heat settings (high/medium/low) for precise heating control
- Features 4 pockets: zippered chest pocket, side pockets (left and right) and lower left pocket

DCV200Z Includes: Vest only, battery & charger not included (PE0000017)

Model	Size	Model	Size
DCV200ZS	Small	DCV200ZXL	X-Large
DCV200ZM	Medium	DCV200Z2XL	2X-Large
DCV200ZL	Large	DCV200Z3XL	3X-Large

Available Sizes:	Small, Medium, Large, X-Large, 2X-Large, 3X-Large
Heat Settings	High-Medium-Low
Battery	18V LXT® Lithium-Ion
Number of Pockets	5 (including battery pocket)
USB Power Port	1
Net Weight (with battery)	3.8 lbs.
Shipping Weight	1.7 lbs.

18V LITHIUM-ION BATTERIES



BL1860B (1-Pack)
BL1860B-2 (2-Pack) **6.0Ah BATTERY** **55 Minute Charge Time**

18V LXT® Lithium-Ion 6.0Ah Battery

- Integrated L.E.D. battery charge level indicator allows user to monitor battery charge
- Provides up to 2X more run time per charge compared to BL1830
- Reaches full charge in 55 minutes or less



BL1850B (1-Pack)
BL1850B-2 (2-Pack) **5.0Ah BATTERY** **45 Minute Charge Time**

18V LXT® Lithium-Ion 5.0Ah Battery

- Integrated L.E.D. battery charge level indicator allows user to monitor battery charge
- Provides up to 65% more run time per charge compared to BL1830
- Reaches full charge in 45 minutes or less



BL1840B (1-Pack)
BL1840B-2 (2-Pack) **4.0Ah BATTERY** **40 Minute Charge Time**

18V LXT® Lithium-Ion 4.0Ah Battery

- Integrated L.E.D. battery charge level indicator allows user to monitor battery charge
- Provides up to 35% more run time per charge compared to BL1830
- Reaches full charge in 40 minutes or less



BL1830B (1-Pack)
BL1830B-2 (2-Pack)
BL1830B-10 (10-Pack) **3.0Ah BATTERY** **30 Minute Charge Time**

18V LXT® Lithium-Ion 3.0Ah Battery

- Integrated L.E.D. battery charge level indicator allows user to monitor battery charge
- Reaches full charge in 30 minutes or less
- Compatible only with Star Protection tools, indicated by the Star Symbol™ and/or Yellow Battery Receiver under the tool



BL1820B (1-Pack)
BL1820B-2 (2-Pack) **2.0Ah BATTERY** **25 Minute Charge Time**

18V LXT® Lithium-Ion Compact 2.0Ah Battery

- Integrated L.E.D. battery charge level indicator allows user to monitor battery charge
- Provides up to 50% more run time per charge compared to BL1815
- Reaches full charge in 25 minutes or less



18V LITHIUM-ION CHARGERS



DC18RC

18V LXT® Lithium-Ion Rapid Optimum Charger

- Charges an 18V LXT® Lithium-Ion 3.0Ah battery in only 30 minutes
- Charges an 18V LXT® Lithium-Ion 4.0Ah battery in only 40 minutes
- Charges an 18V LXT® Lithium-Ion 5.0Ah battery in only 45 minutes
- Charges an 18V LXT® Lithium-Ion 6.0Ah battery in only 55 minutes
- Charges an 18V LXT® Compact Lithium-Ion 2.0Ah battery in only 25 minutes
- The Makita Rapid Optimum Charger communicates with the battery's built-in chip throughout the charging process to optimize battery life



DC18RD

18V LXT® Lithium-Ion Dual Port Charger

- Charges two (2) 18V Compact Lithium-Ion 2.0Ah batteries in only 25 minutes
- Charges two (2) 18V LXT® Lithium-Ion 3.0Ah batteries in only 30 minutes
- Charges two (2) 18V LXT® Lithium-Ion 4.0Ah batteries in only 40 minutes
- Charges two (2) 18V LXT® Lithium-Ion 5.0Ah batteries in only 45 minutes
- Charges two (2) 18V LXT® Lithium-Ion 6.0Ah batteries in only 55 minutes



DC18SF

18V LXT® Lithium-Ion 4-Port Charger

- Charges 2 18V LXT® 3.0Ah batteries in 60 minutes and 4 18V LXT® 3.0Ah batteries in 120 minutes
- Charges 2 18V LXT® Compact 2.0Ah batteries in 30 minutes and 4 18V LXT® Compact 2.0Ah batteries in 60 minutes
- Charger indicators provide updates on charging progress or charging status



DC18SE

18V LXT® Optimum Automotive Charger

- Compatible with 12-volt DC outlets found in most autos and trucks.
- Charges Makita 18V LXT® Lithium-Ion slide-style batteries
- Durable and compact design



18V LITHIUM-ION POWER SOURCE



ADP05

18V LXT® Cordless Power Source (Power Source Only)

- Charges up to 2 USB compatible electronic devices where AC power is not available
- 2 USB ports provide quick and easy charging
- 2.1A output from each USB port, 4.2A total output when both USB ports are connected



SYNC LOCK™



BPS01

18V LXT® Sync Lock® Battery Terminal

- Disables operation and charging of Makita 18V LXT® Batteries by programming a lock-out schedule (preset day, time, and calendar)
- Software enabled system to limit distractions on job sites that may be caused by mobile devices
- Pass code protected to ensure only authorized users can manipulate the system





12V max CXT™ LITHIUM-ION

CXT™ is the next generation in 12-volt max cordless tools. 12V max CXT™ gives users a more compact solution with more comfort and more capacity. The slide style lithium-ion batteries provide superior ergonomics and comfort, and allow go-to tools like the impact driver and drills to stand up on their own for added convenience. Select 12V max CXT™ tools are equipped with efficient brushless motors for longer run time, increased power and speed, and longer tool life. For even longer run time, the expanding 12V max CXT™ platform includes an efficient 4.0Ah battery.



CT409R

- 12V max CXT® 3/8" Driver-Drill (FD05Z)
- 12V max CXT® Impact Driver (DT03Z)
- 12V max CXT® L.E.D. Flashlight (ML103)
- 12V max CXT® Compact Job Site Radio (RM02)
- (2) 12V max CXT® Lithium-Ion 2.0Ah Battery (BL1021B)
- 12V max CXT® Lithium-Ion Charger (DC10WD)



NEW CT410

- 12V max CXT® 3/8" Driver-Drill (FD05Z)
- 12V max CXT® Impact Driver (DT03Z)
- 12V max CXT® 3/8" Impact Wrench (WT02Z)
- 12V max CXT® L.E.D. Flashlight (ML103)
- 12V max CXT® Lithium-Ion Charger (DC10WD)
- 14" Contractor Tool Bag (831253-8)
- (2) 12V max CXT™ 1.5Ah batteries



NEW CT324

- 12V max CXT® Impact Driver (DT03Z)
- 12V max CXT® 3/8" Impact Wrench (WT02Z)
- 12V max CXT® L.E.D. Flashlight (ML103)
- 12V max CXT® Lithium-Ion Charger (DC10WD)
- 14" Contractor Tool Bag (831253-8)
- (2) 12V max CXT™ 1.5Ah batteries (BL1016)



NEW CT323

- 12V max CXT® 3/8" Driver-Drill (FD05Z)
- 12V max CXT® 3/8" Impact Wrench (WT02Z)
- 12V max CXT® L.E.D. Flashlight (ML103)
- 12V max CXT® Lithium-Ion Charger (DC10WD)
- 14" Contractor Tool Bag (831253-8)
- (2) 12V max CXT™ 1.5Ah batteries



CT321RX

- 12V max CXT® 3/8" Driver-Drill (FD05Z)
- 12V max CXT® Impact Driver (DT03Z)
- 12V max CXT® L.E.D. Flashlight (ML103)
- (2) 12V max CXT® Lithium-Ion 2.0Ah Battery (BL1021B)
- 12V max CXT® Lithium-Ion Charger (DC10WD)



CT227R

- 12V max CXT® 3/8" Driver-Drill (FD05Z)
- 12V max CXT® 3-3/8" Circular Saw (SH02Z)
- (2) 12V max CXT® Lithium-Ion 2.0Ah Battery (BL1021B)
- 12V max CXT® Lithium-Ion Charger (DC10WD)



CT226RX

- 12V max CXT® 3/8" Driver-Drill (FD05Z)
- 12V max CXT® Impact Driver (DT03Z)
- (2) 12V max CXT® Lithium-Ion 2.0Ah Battery (BL1021B)
- 12V max CXT® Lithium-Ion Charger (DC10WD)



CT226

- 12V max CXT® 3/8" Driver-Drill (FD05Z)
- 12V max CXT® Impact Driver (DT03Z)
- 12V max CXT® Lithium-Ion Charger (DC10WD)
- 14" Contractor Tool Bag (831253-8)
- (2) 12V max CXT™ 1.5Ah batteries



CXT BRUSHLESS

PH05R1

PH05Z

12V max CXT® Brushless 3/8" Hammer Driver-Drill Kit

- Compact and ergonomic design at only 6-5/8" long
- Weighs only 2.4 lbs. with battery for reduced operator fatigue
- BL™ Brushless Motor delivers 280 in.lbs. of Max Torque
- The BL™ Brushless Motor eliminates carbon brushes, enabling the BL Motor to run cooler and more efficiently for longer life
- Efficient BL™ Brushless motor is electronically controlled to optimize battery energy use for up to 50% longer run time per charge
- The electronically-controlled BL™ Brushless Motor efficiently uses energy to match torque and RPM to the changing demands of the application

PH05R1 Includes: 12V max CXT® Brushless 3/8" Hammer Driver-Drill (PH05Z), (2) 12V max CXT® Lithium-Ion 2.0Ah Battery (BL1021B), 12V max CXT® Lithium-Ion Charger (DC10WD), Tool Case

PH05Z Includes: Tool only, battery & charger not included

Capacity (steel)	3/8"
Capacity (wood)	1-1/8"
Capacity (masonry)	5/16"
No Load Speed (var. 2 spd)	0 - 450 / 0 - 1,500 RPM
Blows Per Minute (2 speed)	0 - 6,750 / 0 - 22,500 BPM
Maximum Torque (in.lbs./N•m)	280 in.lbs./N•m
Battery	12V max CXT® Lithium-Ion
Overall Length	6-5/8"
Net Weight (with battery)	2.4 lbs.
Shipping Weight	7.2 lbs.



CXT

PH04R1

PH04Z

12V max CXT™ 3/8" Hammer Driver-Drill Kit

- Variable 2-speed design (0-450 & 0-1,700 RPM) covers a wide range of drilling and driving applications
- Makita-built motor delivers 250 in.lbs. of Max Torque
- Compact and ergonomic design at only 7-7/8" long
- Weighs only 2.5 lbs. with battery for reduced operator fatigue
- 12V slide battery design enables the tool to stand on its own for user convenience
- Ergonomically designed handle with rubberized soft grip provides increased comfort

PH04R1 Includes: (2) 12V max CXT™ Lithium-Ion 2.0Ah Battery (BL1021B), 12V max CXT™ Lithium-Ion Charger (DC10WD), Tool Case

PH04Z Includes: Tool only, battery & charger not included

Capacity (steel)	3/8"
Capacity (wood)	13/16"
Capacity (masonry)	5-1/16"
No Load Speed (var. 2 spd)	0 - 450 / 0 - 1,700 RPM
Blows Per Minute (2 speed)	0 - 6,750 / 0 - 25,500 BPM
Maximum Torque (in.lbs./N•m)	250 in.lbs./28N•m
Battery	12V max CXT™ Lithium-Ion
Overall Length	7-7/8"
Net Weight (with battery)	2.5 lbs.
Shipping Weight	6.8 lbs.



CXT BRUSHLESS

FD07R1

FD07Z

12V max CXT® Brushless 3/8" Driver-Drill Kit

- Compact and ergonomic design at only 6-1/16" long
- Weighs only 2.3 lbs. with battery for reduced operator fatigue
- BL™ Brushless Motor delivers 280 in.lbs. of Max Torque
- The BL™ Brushless Motor eliminates carbon brushes, enabling the BL Motor to run cooler and more efficiently for longer life
- Efficient BL™ Brushless motor is electronically controlled to optimize battery energy use for up to 50% longer run time per charge
- The electronically-controlled BL™ Brushless Motor efficiently uses energy to match torque and RPM to the changing demands of the application

FD07R1 Includes: 12V max CXT® Brushless 3/8" Driver-Drill (FD07Z), (2) 12V max CXT® Lithium-Ion 2.0Ah Battery (BL1021B), 12V max CXT® Lithium-Ion Charger (DC10WD), Tool Case

FD07Z Includes: Tool only, battery & charger not included

Capacity (steel)	3/8"
Capacity (wood)	1-1/8"
No Load Speed (var. 2 spd)	0 - 450 / 0 - 1,500 RPM
Maximum Torque (in.lbs./N•m)	280 in.lbs./N•m
Battery	12V max CXT® Lithium-Ion
Overall Length	6-1/16"
Net Weight (with battery)	2.3 lbs.
Shipping Weight	7.2 lbs.



CXT

FD05R1

FD05Z

12V max CXT® 3/8" Driver-Drill Kit

- Variable 2-speed design (0-450 & 0-1,700 RPM) covers a wide range of drilling and driving applications
- Makita-built motor delivers 250 in.lbs. of Max Torque
- Ergonomically designed handle with rubberized soft grip provides increased comfort
- 12V max CXT® slide battery design enables the tool to stand on its own for user convenience
- Compact and ergonomic design at only 7-7/16" long
- Weighs only 2.4 lbs. with battery for reduced operator fatigue

FD05R1 Includes: 12V max CXT® 3/8" Driver-Drill (FD05Z), (2) 12V max CXT® Lithium-Ion 2.0Ah Battery (BL1021B), 12V max CXT® Lithium-Ion Charger (DC10WD), Tool Case

FD05Z Includes: Tool only, battery & charger not included

Capacity (steel)	3/8"
Capacity (wood)	13/16"
No Load Speed (var. 2 spd)	0 - 450 / 0 - 1,700 RPM
Maximum Torque (in.lbs./N•m)	250 in.lbs./28N•m
Battery	12V max CXT® Lithium-Ion
Overall Length	7-7/16"
Net Weight (with battery)	2.4 lbs.
Shipping Weight	8.8 lbs.



CXT BRUSHLESS

DT04R1

DT04Z

12V max CXT® Brushless Impact Driver Kit

- BL™ Brushless Motor delivers 1,200 in.lbs. of Max Torque in an ultra compact design
- Assist Mode (A-mode) feature helps eliminate "screw cam-out" and "cross threading" by driving at low speed until tightening begins
- Variable 2-speed (0-1,300/0-3,000 RPM & 0-1,600/0-3,900 IPM) for a wide range of fastening applications
- Compact and ergonomic design at only 5-5/16" long
- Weighs only 2.1 lbs. with battery for reduced operator fatigue

DT04R1 Includes: 12V max CXT® Brushless Impact Driver (DT04Z), (2) 12V max CXT® Lithium-Ion 2.0Ah Battery (BL1021B), 12V max CXT® Lithium-Ion Charger (DC10WD), Tool Case

DT04Z Includes: Tool only, battery & charger not included

Hex Shank	1/4"
No Load Speed (var. 2 spd)	0 - 1,300 / 0 - 3,000 RPM
Impacts Per Minute (var. 2 spd.)	0 - 1,600 / 0 - 3,900 IPM
Maximum Torque (in.lbs./N•m)	1,200 in.lbs./135N•m
Battery	12V max CXT® Lithium-Ion
Overall Length	5-5/16"
Net Weight (with battery)	2.1 lbs.
Shipping Weight	6.9 lbs.



CXT

DT03R1

DT03Z

12V max CXT® Impact Driver Kit

- Variable speed (0-2,600 RPM & 0-3,500 IPM) for a wide range of fastening applications
- Motor delivers 970 in.lbs. of Max Torque in an ultra compact size
- Ergonomically designed handle with rubberized soft grip provides increased comfort
- 12V slide battery design enables the tool to stand on its own for user convenience
- Compact and ergonomic design at only 6" long
- Weighs only 2.3 lbs. with battery for reduced operator fatigue

DT03R1 Includes: 12V max CXT® Impact Driver (DT03Z), (2) 12V max CXT® Lithium-Ion 2.0Ah Battery (BL1021B), 12V max CXT® Lithium-Ion Charger (DC10WD), Tool Case

DT03Z Includes: Tool only, battery & charger not included

Hex Shank	1/4"
No Load Speed (variable speed)	0 - 2,600 RPM
Impacts Per Minute (variable speed)	0 - 3,500 IPM
Maximum Torque (in.lbs./N•m)	970 in.lbs./110N•m
Battery	12V max CXT® Lithium-Ion
Overall Length	6"
Net Weight (with battery)	2.3 lbs.
Shipping Weight	6.65 lbs.



CXT

FD06R1

FD06Z

12V max CXT® 1/4" Hex Driver-Drill Kit

- Variable 2-speed design (0-450 & 0-1,700 RPM) covers a wide range of drilling and driving applications
- Makita-built motor delivers 250 in.lbs. of Max Torque
- Compact and ergonomic design at only 6-3/16" long
- Weighs only 2.1 lbs. with battery for reduced operator fatigue
- 12V slide battery design enables the tool to stand on its own for user convenience
- Ergonomically designed handle with rubberized soft grip provides increased comfort

FD06R1 Includes: 12V max CXT® 1/4" Hex Driver-Drill (FD06Z), (2) 12V max CXT® Lithium-Ion 2.0Ah Battery (BL1021B), 12V max CXT® Lithium-Ion Charger (DC10WD), Tool Case

FD06Z Includes: Tool only, battery & charger not included

Capacity (steel)	3/8"
Capacity (wood)	13/16"
Hex Shank	1/4"
No Load Speed (var. 2 spd)	0 - 450 / 0 - 1,700 RPM
Battery	12V max CXT® Lithium-Ion
Overall Length	6-3/16"
Net Weight (with battery)	2.1 lbs.
Shipping Weight	8.8 lbs.



CXT

AD03R1

AD03Z

12V max CXT® 3/8" Right Angle Drill Kit

- Makita-built motor delivers up to 245 in.lbs. of Max Torque
- Variable speed (0-1,100 RPM) for a wide range of drilling and driving applications
- 3/8" keyed metal chuck for improved bit gripping power
- Compact 2-1/2" angle head height for use in close quarters
- Compact and ergonomic design at only 12-3/8" long
- Weighs only 2.6 lbs. with battery for reduced operator fatigue

AD03R1 Includes: 12V max CXT® 3/8" Right Angle Drill (AD03Z), (2) 12V max CXT® Lithium-Ion 2.0Ah Battery (BL1021B), 12V max CXT® Lithium-Ion Charger (DC10WD), Tool Case

AD03Z Includes: Tool only, battery & charger not included

Capacity (steel)	3/8"
Capacity (wood)	1/2"
No Load Speed (variable speed)	0 - 1,100 RPM
Maximum Torque (in.lbs./N•m)	245 in.lbs./27N•m
Battery	12V max CXT® Lithium-Ion
Overall Length	12-3/8"
Net Weight	2.6 lbs.
Shipping Weight	8.93 lbs.



CX1
NEW **AD04R1** **AD04Z** **Z**

12V max CXT® 3/8" Right Angle Drill Kit

- Makita-built motor delivers up to 245 in.lbs. of Max Torque
- Variable speed (0-1,100 RPM) for a wide range of drilling and driving applications
- Compact and ergonomic design at only 12-3/8" long
- Weighs only 2.7 lbs. with battery for reduced operator fatigue
- Ergonomic barrel grip design for added comfort
- Easy-to-operate paddle switch with variable speed control

AD04R1 Includes: 12V max CXT® 3/8" Right Angle Drill (AD04Z), (2) 12V max CXT® Lithium-Ion 2.0Ah Battery (BL1021B), 12V max CXT® Lithium-Ion Charger (DC10WD), Tool Case

AD04Z Includes: Tool only, battery & charger not included

Capacity (steel)	3/8"
Capacity (wood)	1/2"
No Load Speed (variable speed)	0 - 1,100 RPM
Maximum Torque (in.lbs./N•m)	245 in.lbs./27N•m
Battery	12V max CXT® Lithium-Ion
Overall Length	12-3/8"
Net Weight	2.7 lbs.
Shipping Weight	9.45 lbs.



CX1
NEW **WT02R1** **WT02Z** **Z**

12V max CXT® 3/8" Impact Wrench Kit

- Variable speed (0-2,600 RPM & 0-3,200 IPM) for a wide range of fastening applications
- Ultra-compact design at only 6-3/8" long and weighs only 2.3 lbs. with battery for reduced operator fatigue
- Built-in L.E.D. light illuminates the work area
- Ergonomically designed handle with rubberized soft grip provides increased comfort
- Ideal for working in tight spaces and overhead applications
- Convenient 3/8" square drive for quick socket changes

WT02R1 Includes: 12V max CXT® 3/8" Impact Wrench (WT02Z), (2) 12V max CXT® Lithium-Ion 2.0Ah Battery (BL1021B), 12V max CXT® Lithium-Ion Charger (DC10WD), Tool bag

WT02Z Includes: Tool only, battery & charger not included

Square Drive	3/8"
No Load Speed (variable speed)	0 - 2,600 RPM
Impacts Per Minute (variable speed)	0 - 3,200 IPM
Maximum Torque (ft.lbs./N•m)	103 ft.lbs./139 N•m
Nut-Busting Torque (ft.lbs./N•m)	200 ft.lbs./270 N•m
Battery	12V max CXT® Lithium-Ion
Overall Length	6-3/8"
Net Weight (with battery)	2.3 lbs.
Shipping Weight	5.96 lbs.



CX1
NEW **LT01R1** **LT01Z** **Z**

12V max CXT® Angle Impact Driver Kit

- Makita-built motor delivers 530 in.lbs. of Max Torque
- Variable speed (0-2,000 RPM & 0-3,000 IPM) for a wide range of fastening applications
- Compact 2-1/8" angle head height for use in close quarters
- Large paddle switch with soft grip provides increased comfort
- Long, ergonomic body design provides maximum reach
- Weighs only 2.8 lbs. with battery for reduced operator fatigue

LT01R1 Includes: 12V max CXT® Angle Impact Driver (LT01Z), (2) 12V max CXT® Lithium-Ion 2.0Ah Battery (BL1021B), #2 Phillips Double Ended Bit (784202-3), 12V max CXT® Lithium-Ion Charger (DC10WD), Tool Case

LT01Z Includes: Tool only, battery & charger not included

Hex Shank	1/4"
No Load Speed (variable speed)	0 - 2,000 RPM
Impacts Per Minute (variable speed)	0 - 3,000 IPM
Maximum Torque (in.lbs./N•m)	530 in.lbs./60N•m
Battery	12V max CXT® Lithium-Ion
Overall Length	14-1/4"
Net Weight (with battery)	2.8 lbs.
Shipping Weight	9.42 lbs.



CX1
NEW **LT02R1** **LT02Z** **Z**

12V max CXT® 3/8" Angle Impact Wrench Kit

- Makita-built motor delivers 44 ft.lbs. of Max Torque
- Variable speed (0-2,000 RPM & 0-3,000 IPM) for a wide range of fastening applications
- Compact 1-11/16" angle head height for use in close quarters
- Long, ergonomic body design provides maximum reach
- Weighs only 2.8 lbs. with battery for reduced operator fatigue
- Large conveniently located paddle switch for comfortable operation

LT02R1 Includes: 12V max CXT® Angle Impact Wrench (LT02Z), (2) 12V max CXT® Lithium-Ion 2.0Ah Battery (BL1021B), 12V max CXT® Lithium-Ion Charger (DC10WD), Tool Case

LT02Z Includes: Tool only, battery & charger not included

Square Drive	3/8"
No Load Speed (variable speed)	0 - 2,000 RPM
Impacts Per Minute (variable speed)	0 - 3,000 IPM
Maximum Torque (ft.lbs./N•m)	44 ft.lbs./60 N•m
Battery	12V max CXT® Lithium-Ion
Overall Length	14-1/4"
Net Weight (with battery)	2.8 lbs.
Shipping Weight	9.42 lbs.



CX1
NEW **GC01ZC**

12V max CXT™ 29 oz. Caulk and Adhesive Gun

- Makita-built motor delivers 1,100 lbs. of dispensing force to dispense the highest viscosity adhesives and sealants
- 5 speed dial optimizes flow rate from 0-66 IPM
- Variable speed trigger allows user match speed to the application
- Drip-reduction feature automatically relieves pressure to the material when trigger is released to prevent unintentional dispensing
- Overload indicator light notifies the operator when tool is nearly overloaded to minimize breakage of the sealant cartridge
- Compact and ergonomic design at 18-7/8" long

GC01ZC Includes: Tool only, battery & charger not included 29 oz. Cartridge Holder Set (197195-9)

Capacity (caulk or sealants)	29 oz.
Dispense Force	1,100 lbs.
Inches Per Minute (variable speed)	0 - 66 IPM
Speed Settings	5
Battery	12V max CXT™ Lithium-Ion
Overall Length	21-1/4"
Net Weight (with battery)	5 lbs.
Shipping Weight	6.8 lbs.



CX1
NEW **GC01ZB**

12V max CXT™ 20 oz. Caulk and Adhesive Gun

- Makita-built motor delivers 1,100 lbs. of dispensing force to dispense the highest viscosity adhesives and sealants
- 5 speed dial optimizes flow rate from 0-66 IPM
- Variable speed trigger allows user match speed to the application
- Drip-reduction feature automatically relieves pressure to the material when trigger is released to prevent unintentional dispensing
- Overload indicator light notifies the operator when tool is nearly overloaded to minimize breakage of the sealant cartridge
- Compact and ergonomic design at 21-1/4" long

GC01ZB Includes: Tool only, battery & charger not included 20 oz. Barrel Holder Set (196352-6)

Capacity (caulk or sealants)	20 oz.
Dispense Force	1,100 lbs.
Inches Per Minute (variable speed)	0 - 66 IPM
Speed Settings	5
Battery	18V LXT™ Lithium-Ion
Overall Length	21-1/4"
Net Weight	5.5 lbs.
Shipping Weight	7.5 lbs.



CX1
NEW **GC01ZA**

12V max CXT™ 10 oz. Caulk and Adhesive Gun

- Makita-built motor delivers 1,100 lbs. of dispensing force to dispense the highest viscosity adhesives and sealants
- 5 speed dial optimizes flow rate from 0-66 IPM
- Variable speed trigger allows user match speed to the application
- Drip-reduction feature automatically relieves pressure to the material when trigger is released to prevent unintentional dispensing
- Overload indicator light notifies the operator when tool is nearly overloaded to minimize breakage of the sealant cartridge
- Compact and ergonomic design at 15-7/8" long

GC01ZA Includes: Tool only, battery & charger not included 10 oz. Cartridge Holder Set (196351-8)

Capacity (caulk or sealants)	10 oz.
Dispense Force	1,100 lbs.
Inches Per Minute (variable speed)	0 - 66 IPM
Speed Settings	5
Battery	12V max CXT™ Lithium-Ion
Overall Length	15-7/8"
Net Weight	4.2 lbs.
Shipping Weight	5.5 lbs.



CX1
NEW **SH02R1** **SH02Z** **Z**

12V max CXT™ 3-3/8" Circular Saw Kit

- Makita-built motor delivers 1,500 RPM for faster cutting
- 3-3/8" blade delivers a maximum cutting depth of 1" for a wide range of cutting applications
- Adjustable cutting depth from 1" at 90° and 5/8" at 45°
- Tilting base for bevel cuts from 0° - 45°
- Cuts plywood, MDF, pegboard, particleboard, melamine, drywall and more
- Only use genuine Makita batteries and chargers

SH02R1 Includes: 12V max CXT® 3-3/8" Circular Saw (SH02Z), (2) 12V max CXT® Lithium-Ion 2.0Ah Battery (BL1021B), 12V max CXT® Lithium-Ion Charger (DC10WD), 3-3/8" 20T C.T. Saw Blade (A-95021), Tool Case

SH02Z Includes: Tool only, battery & charger not included 3-3/8" 20T C.T. Saw Blade (A-95021)

Blade Diameter	3-3/8"
Arbor (mm)	15 mm
Max. Cutting Capacity (at 90°)	1"
Max. Cutting Capacity (at 45°)	5/8"
No Load Speed	1,500 RPM
Battery	12V max CXT™ Lithium-Ion
Overall Length	12-3/8"
Net Weight (with battery)	3.5 lbs.
Shipping Weight	11.7 lbs.



CXT BRUSHLESS

VJ05R1J

VJ05Z

12V max CXT® Brushless Barrel Grip Jig Saw Kit

- Makita-built brushless motor and 3 orbital settings plus straight cutting deliver faster and more accurate cuts in a variety of materials
- Variable 5-speed control dial (800-3,000 SPM) enables user to match the speed to the application
- Soft start suppresses start-up reaction for better accuracy
- No-load speed reduction feature automatically reduces SPM for more accurate cutting starts
- Efficient BL™ Brushless Motor is electronically controlled to optimize battery energy use for up to 50% longer run time per charge

VJ05R1J Includes: 12V max CXT® Brushless Barrel Grip Jig Saw (VJ05Z), (2) 12V max CXT® Lithium-Ion 2.0Ah Battery (BL1021B), 12V max CXT® Lithium-Ion Charger (DC10WD), Jig Saw Blade, Tool Case

VJ05Z Includes: Tool only, battery & charger not included Jigsaw Blade

Length of Stroke	7/8"
Max. Cutting Capacity at 90° (aluminum)	13/16"
Max. Cutting Capacity at 90° (mild steel)	3/8"
Max. Cutting Capacity at 90° (wood)	3-1/2"
Strokes Per Minute (variable speed)	800 - 3,000 SPM
Blade Shank	"T" Tang
Battery	12V max CXT® Lithium-Ion
Overall Length	9-3/8"
Net Weight (with battery)	3.9 lbs.
Shipping Weight	10.14 lbs.



CXT BRUSHLESS

VJ06R1J

VJ06Z

12V max CXT® Brushless Top Handle Jig Saw Kit

- Makita-built brushless motor and 3 orbital settings plus straight cutting deliver faster and more accurate cuts in a variety of materials
- Variable 5-speed control dial (800-3,000 SPM) enables user to match the speed to the application
- Soft start suppresses start-up reaction for better accuracy
- No-load speed reduction feature automatically reduces SPM for more accurate cutting starts
- Efficient BL™ Brushless Motor is electronically controlled to optimize battery energy use for up to 50% longer run time per charge

VJ06R1J Includes: 12V max CXT® Brushless Top Handle Jig Saw (VJ06Z), (2) 12V max CXT® Lithium-Ion 2.0Ah Battery (BL1021B), 12V max CXT® Lithium-Ion Charger (DC10WD), Interlocking Case, Small, 4-3/8"x15-1/2"x11-5/8" (821549-5), Jig Saw Blade

VJ06Z Includes: Tool only, battery & charger not included Jig Saw Blade

Length of Stroke	7/8"
Max. Cutting Capacity at 90° (aluminum)	13/16"
Max. Cutting Capacity at 90° (mild steel)	3/8"
Max. Cutting Capacity at 90° (wood)	3-1/2"
Strokes Per Minute (variable speed)	800 - 3,000 SPM
Blade Shank	"T" Tang
Battery	12V max CXT® Lithium-Ion
Overall Length	9-3/8"
Net Weight (with battery)	4.1 lbs.
Shipping Weight	9.92 lbs.



CXT

VJ04R1

VJ04Z

12V max CXT® Jig Saw Kit

- Makita-built variable speed motor delivers 0-2,900 strokes per minute
- 3 orbital settings plus straight cutting for use in a wide range of materials
- Compact and ergonomic design at 9-1/8" long
- Weighs only 3.8 lbs. with battery for reduced operator fatigue
- Dust port for use with a vacuum provides efficient dust management
- Low profile design engineered for improved handling in compact areas

VJ04R1 Includes: 12V max CXT® Jig Saw (VJ04Z), (2) 12V max CXT® Lithium-Ion 2.0Ah Battery (BL1021B), 12V max CXT® Lithium-Ion Charger (DC10WD), Jig Saw Blade (723053-9), Tool Case (821691-2)

VJ04Z Includes: Tool only, battery & charger not included Jig Saw Blade

Length of Stroke	11/16"
Max. Cutting Capacity at 90° (aluminum)	5/32"
Max. Cutting Capacity at 90° (mild steel)	1/16"
Max. Cutting Capacity at 90° (wood)	2-9/16"
Strokes Per Minute	2,900 SPM
Blade Shank	"T" Tang
Battery	12V max CXT® Lithium-Ion
Overall Length	9-1/8"
Net Weight (with battery)	3.8 lbs.
Shipping Weight	11 lbs.



CXT

RJ03R1

RJ03Z

12V max CXT® Recipro Saw Kit

- Variable speed motor delivers 0-3,300 strokes per minute combined with a 1/2" length stroke to provide faster cutting
- Exclusive dual-position on/off switch design allows for either paddle switch or trigger switch operation
- "Tool-less" blade change system allows for faster blade installation and removal for increased productivity
- Compact design at 14-3/4" long
- Weighs only 2.9 lbs. with battery for convenient operation
- Built-in L.E.D. light illuminate the work area

RJ03R1 Includes: 12V max CXT® Recipro Saw (RJ03Z), (2) 12V max CXT® Lithium-Ion 2.0Ah Battery (BL1021B), 12V max CXT® Lithium-Ion Charger (DC10WD), 4" Metal Cutting Recipro Saw Blade, 18TPI (B-20404), 4" 6TPI Wood Cutting Recipro Saw Blade, 5pk (B-20432), Tool Case

RJ03Z Includes: Tool only, battery & charger not included 4" Metal Cutting Recipro Saw Blade, 18TPI (B-20404)

Length of Stroke	1/2"
Max. Cutting Capacity (wood)	2"
Max. Cutting Capacity (pipe)	2"
Strokes Per Minute (variable speed)	0 - 3,300 SPM
Battery	12V max CXT® Lithium-Ion
Overall Length	14-3/4"
Net Weight (with battery)	2.9 lbs.
Shipping Weight	14.5 lbs.



CXT

CC02R1

CC02Z

12V max CXT® 3-3/8" Tile/Glass Saw Kit

- Makita-built motor delivers 1,600 RPM for faster and powerful cutting
- 3-3/8" blade delivers a maximum cutting depth of 1" for a wide range of cutting applications
- Compact and ergonomic design at only 12-3/8" long
- Weighs only 4.2 lbs. with battery for reduced operator fatigue
- Nickel-plated tilting base for bevel cuts from 0° to 45°
- Adjustable cutting depth up to 1" at 90° and 5/8" at 45°

CC02R1 Includes: 12V max CXT® 3-3/8" Tile/Glass Saw (CC02Z), (2) 12V max CXT® Lithium-Ion 2.0Ah Battery (BL1021B), 12V max CXT® Lithium-Ion Charger (DC10WD), 3-3/8" Diamond Blade, Tile/Glass (A-95722)

CC02Z Includes: Tool only, battery & charger not included 3-3/8" Diamond Blade, Tile/Glass (A-95722)

Blade Diameter	3-3/8"
Arbor (mm)	15 mm
Max. Cutting Capacity (at 90°)	1"
Max. Cutting Capacity (at 45°)	5/8"
No Load Speed	1,600 RPM
Battery	12V max CXT® Lithium-Ion
Overall Length	12-3/8"
Net Weight (with battery)	4.2 lbs.
Shipping Weight	7.2 lbs.



CXT

PC01R3

PC01Z

12V max CXT® Multi-Cutter Kit

- Cuts cardboard, carpet, leather, rubber, vinyl and more up to 1/4" thick
- Self-sharpening blade feature ensures maximum cutting efficiency
- Built-in sight line for precise cutting
- Weighs only 1.6 lbs. with battery for reduced operator fatigue
- Compact and ergonomic design at only 10-3/4" long
- Makita-built motor delivers 300 RPM for cutting a wide range of material

PC01R3 Includes: 12V max CXT® Multi-Cutter (PC01Z), 12V max CXT® Lithium-Ion 2.0Ah Battery (BL1021B), 12V max CXT® Lithium-Ion Charger (DC10WD), 1-5/8" Multi-Cutter Blade (198604-1), Tool Bag

PC01Z Includes: Tool only, battery & charger not included 1-5/8" Multi-Cutter Blade (198604-1)

Max. Cutting Capacity	1/4"
No Load Speed	300 RPM
Battery	12V max CXT® Lithium-Ion
Overall Length	10-3/4"
Net Weight (with battery)	1.6 lbs.
Shipping Weight	5.1 lbs.



CXT

RH02R1

RH02Z

12V max CXT® 9/16" Rotary Hammer Kit

- Makita-built variable speed motor delivers 0-850 RPM, 0-4,900 BPM and 0.73 ft.lbs./1.0 joules of impact energy for faster drilling
- Compact and Ergonomic design at only 9-11/16"
- Weighs only 4.3 lbs. with battery for reduced operator fatigue
- Vibration absorbing handle moves independently of the motor and hammer mechanism for increased operator comfort
- 2-Mode operation for "Rotation Only" or "Hammering with Rotation"
- Built-in L.E.D. light illuminates the work area

RH02R1 Includes: (2) 12V max CXT® Lithium-Ion 2.0Ah Battery (BL1021B), 12V max CXT® Lithium-Ion Charger (DC10WD), Side Handle (144218-4), Tool Case

RH02Z Includes: Tool only, battery & charger not included Side Handle (144218-4)

Max. Capacity (concrete drilling)	9/16"
Optimum Range (concrete drilling)	5/32" - 3/8"
Impact Energy (Joules)	1 J
Impact Energy (ft.lbs.)	.73
Vibration (m/s²)	6.5
No Load Speed (variable speed)	0 - 850 RPM
Blows Per Minute (variable speed)	0 - 4,900 BPM
Battery	12V max CXT® Lithium-Ion
Overall Length	9-11/16"
Net Weight (with battery)	4.3 lbs.
Shipping Weight	11 lbs.
Bit Type	Accepts SDS-PLUS



CXT BRUSHLESS

RH01R1

RH01Z

12V max CXT® Brushless 5/8" Rotary Hammer Kit

- Brushless motor delivers 0-680 RPM, 0-4,800 BPM and 81ft.lbs./1.1 joules of impact energy for faster drilling
- Compact and Ergonomic design at only 9-7/8"
- Weighs only 4.0 lbs. with battery for reduced operator fatigue
- Vibration absorbing handle moves independently of the motor and hammer mechanism for increased operator comfort
- Efficient BL™ Brushless motor is electronically controlled to optimize battery energy use for up to 50% longer run time per charge
- 2-Mode operation for "Rotation Only" or "Hammering with Rotation"

RH01R1 Includes: 12V max CXT® Brushless 5/8" Rotary Hammer (RH01Z), (2) 12V max CXT® Lithium-Ion 2.0Ah Battery (BL1021B), 12V max CXT® Lithium-Ion Charger (DC10WD), Side Handle (144218-4), Interlocking Case, Medium (197211-7)

RH01Z Includes: Tool only, battery & charger not included Side Handle (144218-4)

Max. Capacity (concrete drilling)	5/8"
Optimum Range (concrete drilling)	5/32" - 3/8"
Impact Energy (Joules)	1.1 J
Impact Energy (ft.lbs.)	.81
Vibration (m/s²)	7.5
No Load Speed (variable speed)	0 - 680 RPM
Blows Per Minute (variable speed)	0 - 4,800 BPM
Battery	12V max CXT® Lithium-Ion
Overall Length	9-7/8"
Net Weight (with battery)	4 lbs.
Shipping Weight	9.65 lbs.
Bit Type	Accepts SDS-PLUS

NEW 12V max CXT™
SELF-LEVELING LASERS
ACCURACY & VISIBILITY

FOR FULL DETAILS SEE PAGE 50



SK105DNAX
12V max CXT™ Self-Leveling
Cross-Line Red Beam Laser



SK105GDNAX
12V max CXT™ Self-Leveling
Cross-Line Green Beam
Laser Kit



SK106DNAX
12V max CXT™ Self-Leveling
Cross-Line/4-Point Red Beam
Laser Kit



SK106GDNAX
12V max CXT™ Self-Leveling
Cross-Line/4-Point Green Beam
Laser Kit



TP03Z

12V max CXT® Pin Nailer, 23 Ga.

- Refined firing mechanism reduces recoil; reduces force required on the work surface when driving pins
- Drives 6 different lengths of 23 gauge pins (5/8", 11/16", 3/4", 1", 1-3/16" and 1-3/8"); magazine capacity up to 120 pins
- Anti-dry fire mechanism engineered to prevent driving blanks and damage to work surface
- "Tool-less" depth adjustment for precise flush and countersink finish
- Cordless for increased convenience; eliminates the need for a compressor and air hose
- Contact trigger for improved accuracy and precision

TP03Z Includes: Tool only, battery & charger not included
Safety Glasses, (2) No-Mar Tips, Belt Hook, Hex Wrench

Max. nail/fastener length	1-3/8" (23 ga.)
Maximum Magazine Capacity	120
Battery	12V max CXT® Lithium-Ion
Overall Length	9-1/8"
Net Weight (with battery)	4 lbs.
Shipping Weight	4.4 lbs.



MT01R1

MT01Z



12V max CXT® Multi-Tool Kit

- Variable speed control dial (6,000-20,000 OPM) enables user to match the speed to the application
- 3.2° oscillation angle engineered for faster cutting and sanding
- Large on/off slide switch with lock-on button for operator convenience
- Built-in L.E.D. on the tip of the tool to illuminate work area
- Hex wrench stores on the tool for easy accessory changes
- Includes adapters to fit most competitor's accessories

MT01R1 Includes: 12V max CXT® Multi-Tool (MT01Z), (2) 12V max CXT® Lithium-Ion 2.0Ah Battery (BL1021B), 12V max CXT® Lithium-Ion Charger (DC10WD), Multi-Tool Adapter (313249-6), Multi-Tool Adapter (196271-6), 1-1/4" Plunge Blade (BIM), 14TPI (A-95255), Tool Case

MT01Z Includes: Tool only, battery & charger not included
Multi-Tool Adapter (313249-6), Multi-Tool Adapter (196271-6), 1-1/4" Plunge Blade (BIM), 14TPI (A-95255)

Oscillations Per Minute	6,000 - 20,000 OPM
Oscillation Angle	3.2°
Battery	12V max CXT® Lithium-Ion
Overall Length	10-7/8"
Net Weight (with battery)	2.4 lbs.
Shipping Weight	9.5 lbs.



RU03ZX

12V max CXT® Trimmer w/ Plastic Blade

- Up to 38 minutes of run time under no load using 4.0Ah battery BL1041B (battery not included)
- Telescoping shaft (32-7/8" to 46-3/4") for optimum cutting position
- Makita-built motor delivers 10,000 RPM for faster cutting
- 180° rotating head allows the trimmer to convert to edger; 9" cutting width
- Weighs only 4.2 lbs. with battery (battery not included) for reduced operator fatigue
- Compact size is ideal for trimming and precise edging

RU03ZX Includes: Tool only, battery & charger not included
Single Cutter Trimmer Head (198847-5)

Cutting Capacity (diameter)	9"
No Load Speed	10,000 RPM
Battery	12V max CXT® Lithium-Ion
Overall Length	46-3/4"
Net Weight (with battery)	4.2 lbs.
Shaft Type	Telescoping
Shipping Weight	7.06 lbs.



RU03Z

12V max CXT® String Trimmer

- Up to 38 minutes of run time under no load using 4.0Ah battery BL1041B (battery not included)
- Telescoping shaft (32-7/8" to 46-3/4") for optimum cutting position
- Makita-built motor delivers 9,000 RPM for faster cutting
- 180° rotating head allows the trimmer to convert to edger; 10-1/4" cutting width
- Compact size is ideal for trimming and precise edging
- Adjustable loop handle for convenient operation

RU03Z Includes: Tool only, battery & charger not included
Bump & Feed Trimmer Head, M8 X 1.25 RH (198853-0)

Cutting Capacity (diameter)	10-1/4"
No Load Speed	9,000 RPM
Battery	12V max CXT® Lithium-Ion
Overall Length	46-3/4"
Net Weight (with battery)	4.2 lbs.
Shaft Type	Telescoping
Shipping Weight	7.12 lbs.



HU06Z

12V max CXT® Hedge Trimmer

- Makita-built motor delivers 2,500 SPM for efficient cutting
- Up to 90 minutes of run time with 4.0Ah battery BL1041B (battery not included)
- 7-7/8" cutting width for optimum performance
- "Tool-less" blade changing system for increased convenience
- One-Touch installing chip receiver attachment for easier clean up
- Dual blade action cuts with a shearing effect for improved results

HU06Z Includes: Tool only, battery & charger not included
Clipping Collector (198402-3), Hedge Trimmer Blade Cover (451816-0)

Blade Length	7-7/8"
Strokes Per Minute	2,500 SPM
Battery	12V max CXT® Lithium-Ion
Overall Length	19-7/8"
Net Weight (with battery)	3.3 lbs.
Shipping Weight	4 lbs.



MU04Z

12V max CXT® Grass Shear

- Makita-built motor delivers 2,500 SPM for efficient cutting
- Up to 90 minutes of run time with 4.0Ah battery BL1041B (battery not included)
- 6-5/16" cutting width for optimum performance
- "Tool-less" blade changing system for increased convenience
- Easy to operate 3 stage cutting height adjustment (19/32", 25/32", 1")
- Dual blade action cuts with a shearing effect for improved results

MU04Z Includes: Tool only, battery & charger not included
Blade Guard, Grass Receiver

Cutting Capacity (width)	6-5/16"
Depth Adjustment Range	9/32", 25/32", 1"
Strokes Per Minute	2,500 SPM
Battery	12V max CXT® Lithium-Ion
Overall Length	13"
Net Weight (with battery)	4.1 lbs.
Shipping Weight	3.6 lbs.



LC08ZW

12V max CXT® Vacuum

- Compact design at only 18" long
- Weighs only 2.3 lbs. with battery for reduced operator fatigue (battery not included)
- Up to 33 minutes of continuous use from a single fully charged 2.0Ah battery BL1021B (battery not included)
- 3-speed and off push buttons for operator convenience
- Built-in L.E.D. light illuminates the work area and light starts to blink once capacity gets low
- Bagless 2-stage cloth filtration system allows for easier cleaning and quicker debris disposal

LC08ZW Includes: Tool only, battery & charger not included
Floor Nozzle (123486-2), Crevice Nozzle (451240-7), Extension Attachment (451241-5), Crevice Nozzle Holder (451242-3), Cloth Vacuum Filter (443060-3), Filter (451208-3)

Capacity (pint)	1.26 pint
Continuous Use (max, in minutes)	33 min.
Battery	12V max CXT® Lithium-Ion
Overall Length	18"
Net Weight (with battery)	2.3 lbs.
Power Type	Cordless
Shipping Weight	3.64 lbs.



Also Available:
Floor Nozzle
123485-4



LC06ZW

12V max CXT® Vacuum

- Compact design at only 18" long
- Weighs only 2.2 lbs. with battery for reduced operator fatigue (battery not included)
- Up to 21 minutes of continuous use from a single fully charged 2.0Ah battery BL1021B (battery not included)
- Built-in L.E.D. light illuminates the work area
- Bagless 2-stage cloth filtration system allows for easier cleaning and quicker debris disposal

LC06ZW Includes: Tool only, battery & charger not included
Extension Attachment (451241-5), Floor Nozzle (123486-2), Crevice Nozzle (451240-7), Crevice Nozzle Holder (451242-3), Filter (451208-3), Cloth Vacuum Filter (443060-3)

Capacity (pint)	1.26 pint
Continuous Use (max. in minutes)	21 min.
Battery	12V max CXT® Lithium-Ion
Overall Length	18"
Net Weight (with battery)	2.2 lbs.
Shipping Weight	3.5 lbs.



XRM08B

18V LXT® / 12V max CXT® Bluetooth® Job Site Speaker

- Equipped with Bluetooth® to wirelessly connect your mobile device to play music a distance up to 33 ft.
- Speaker is operated by menu controls located on the front of the unit
- Up to 32 hours of continuous operation in auxiliary mode and 31 hours with Bluetooth function enabled*
- Protective bumpers are engineered for increased durability
- One auxiliary port for MP3 compatibility, one USB port for charging your mobile device and AC adapter jack for powering speaker
- Delivers rich sound; woofer for low sounds and tweeter for high sounds

XRM08B Includes: Tool only, battery & charger not included
AC Adapter

Voltage	12-18V
USB Power Port	1
Auxiliary Port	Yes
Bluetooth®	Yes
MP3 Compatible	Yes
AC Adapter	Yes
Dimensions (LxWxH)	8-5/16" x 8" x 7-7/8"
Net Weight (with battery)	7.2 lbs.
Shipping Weight	7.5 lbs.

*using battery BL1850B



CF100DZ

12V max CXT® 7-1/8" Fan

- Three speed settings (High/Medium/Low) and Oscillation selector for optimal air velocity and control
- Designed for reduced wind noise level for quiet operation
- Tilts up and down for convenient redirection of air flow
- Adjustable hook for easy handling and hanging
- Battery Protection Circuit protects against overloading, over-discharging and over-heating
- Up to 630 minutes of continuous run time in Low speed with 12V max CXT® 4.0Ah Battery BL1041B (battery not included)

CF100DZ Includes: Tool only, battery & charger not included
AC Adapter

Voltage	12V
AC Adapter	Yes
Run Time (max. in hours)	10.5
Speed Settings	3
Battery	12V max CXT® Lithium-Ion
Dimensions (LxWxH)	5-7/8" x 10-1/4" x 9-7/8"
Net Weight (with battery)	3 lbs.
Shipping Weight	3.153 lbs.



RM02

12V max CXT® Compact Job Site Radio

- Delivers rich stereo sound from two powerful front facing speakers
- Up to 30 hours of continuous use with 4.0Ah battery BL1041B (battery not included)
- 10 Preset FM/AM buttons
- One auxiliary port for MP3/iPod® compatibility
- Earphone jack for private listening
- Equipped with rotating hook for convenient hanging

RM02 Includes: Tool only, battery & charger not included

Voltage	12V
Digital Tuner	FM/AM
Auxiliary Port	Yes
Bluetooth®	No
MP3 Compatible	Yes
AC Adapter	No
Backlit LCD Display	Yes
Dimensions (LxWxH)	6-5/8" x 2-1/4" x 2-15/16"
Net Weight (with battery)	1.7 lbs.
Shipping Weight	1 lbs.



NEW ML106

12V max CXT™ Adjustable Beam L.E.D. Flashlight

- High-luminance single L.E.D. flashlight provides 190 lumens
- Beam adjustment from spot to flood by simply rotating the focusing ring
- 12 position pivoting flashlight head with positive stops from 60° - 110°
- Aluminum flashlight head design for increased durability
- Metal hang hook is convenient and job site durable
- Multi-faceted reflector controls the direction and spread of the light

ML106 Includes: Flashlight only, battery & charger not included

Run Time (max. in hours)	12
Battery	12V max CXT® Lithium-Ion
Lumens	190
Bulb	1 LED
Overall Length	10-5/8"
Net Weight (with battery)	1.7 lbs.
Shipping Weight	.98 lbs.



CJ102DZ

12V max CXT® Heated Jacket

- 3 core heat zones (left chest, right chest, back) for optimum heat distribution
- 3 heat settings (high/ medium/ low) for precise heating control
- Features 4 pockets: zippered chest pocket and side pockets (left and right), sleeve pocket
- On/Off heat controller with 3-stage red L.E.D. indicator
- Battery pocket on rear left side for quick and easy access
- Removable zip off sleeves quickly converts the jacket into a vest

CJ102DZS Includes: Jacket only, battery & charger not included

Sizes:	Small, Medium, Large, X-Large, 2X-Large, 3X-Large
Heat Settings	High-Medium-Low
Battery	12V max CXT® Lithium-Ion
Number of Pockets	5 (including battery pocket)
USB Power Port	1
Zip-off Sleeves	Yes
Net Weight (with battery)	3.4 lbs.
Shipping Weight	3.28 lbs.

7.2V LITHIUM-ION



DF012DSE

7.2V Lithium-Ion 1/4" Hex Driver-Drill Kit

- Makita-built motor delivers 71 in.lbs. of Max Torque in a compact design
- Built-in L.E.D. light flashes when it is time to recharge the battery
- 2-speed design (200 RPM and 650 RPM) for high or low torque applications
- Operates in straight or pistol grip positions
- 21 clutch settings and drill mode for added fastening control (fastening torque range: 32-50 in.lbs.)
- Auto-Stop Clutch: Tool shuts off when clutch disengages for extra fastening control and prevents overdriving the fastener

DF012DSE Includes: (2) 7.2V Lithium-Ion 1.5Ah Battery (BL0715), 7.2V - 12V max Lithium-Ion Charger (DC10WB), #2 Double Ended Phillips Bit (784244-7), (784245-5), Tool Case (824842-6)

Hex Shank	1/4"
Capacity (steel)	3/16"
Capacity (wood)	1/4"
No Load Speed (2 spd)	200/650 RPM
Maximum Torque (in.lbs./N•m)	71 in.lbs./8N•m
Battery	7.2V Compact Lithium-Ion
Overall Length (pistol)	8-5/8"
Overall Length (in-line)	10-3/4"
Net Weight (with battery)	1.2 lbs.
Shipping Weight	5.8 lbs.



TD022DSE

7.2V Lithium-Ion Impact Driver Kit

- Makita-built motor delivers 220 in.lbs. of Max Torque in a compact design
- Variable speed (0-2,450 RPM & 0-3,000 IPM) for a wide range of fastening applications
- Ergonomically located forward/reverse switch for convenient adjustment of rotational speed for precise screw driving
- Operates in straight or pistol grip positions
- Electric brake for maximum productivity
- Built-in L.E.D. light illuminates the work area and flashes when it is time to recharge the battery

TD022DSE Includes: (2) 7.2V Lithium-Ion 1.5Ah Battery (BL0715), 7.2V - 12V max Lithium-Ion Charger (DC10WB), Tool Case (824842-6)

Hex Shank	1/4"
No Load Speed (variable speed)	0 - 2,450 RPM
Impacts Per Minute (variable speed)	0 - 3,000 IPM
Maximum Torque (in.lbs./N•m)	220 in.lbs./25N•m
Battery	7.2V Compact Lithium-Ion
Overall Length (pistol)	8-15/16"
Overall Length (in-line)	11-1/8"
Net Weight (with battery)	1.2 lbs.
Shipping Weight	4.741 lbs.

12V max CXT™ LITHIUM-ION

BATTERIES

CXT

BL1041B

4.0Ah BATTERY



130 Minute Charge Time

12V max CXT® Lithium-Ion 4.0Ah Battery

- Lithium-Ion battery delivers longer run time and lower self-discharge
- Features an integrated L.E.D. battery charge level indicator
- Compact design for less weight
- Part of the expanding 12V max CXT® tool series, combining performance with superior ergonomics in a compact size

*With DC10WB



CXT

BL1021B

2.0Ah BATTERY



70 Minute Charge Time**

12V max CXT® Lithium-Ion 2.0Ah Battery

- Lithium-Ion battery delivers longer run time and lower self-discharge
- Features an integrated L.E.D. battery charge level indicator
- Compact design for less weight
- Part of the expanding 12V max CXT® tool series, combining performance with superior ergonomics in a compact size

**With DC10WD



CHARGERS

CXT

DC10SB

12V max CXT® Lithium-Ion Rapid Optimum Charger

- Charges a 12V max CXT® Lithium-Ion 1.5Ah battery in only 22 minutes
- Charges a 12V max CXT® Lithium-Ion 2.0Ah battery in only 30 minutes
- Charges a 12V max CXT® Lithium-Ion 4.0Ah battery in only 60 minutes
- Charging status lights indicate the time it will take to charge a CXT® battery



CXT

DC10WD

12V max CXT® Lithium-Ion Charger

- Charges a 12V max CXT® Lithium-Ion 1.5Ah battery in only 50 minutes
- Charges a 12V max CXT® Lithium-Ion 2.0Ah battery in only 70 minutes
- Charges a 12V max CXT® Lithium-Ion 4.0Ah battery in only 130 minutes
- Charging status lights indicate the time it will take to charge a CXT® battery



POWER SOURCE

CXT USB

ADP06

12V max CXT® Power Source (Power Source Only)

- Charges 1 USB compatible electronic device where AC power is not available
- USB port provides quick and easy charging
- On-Off switch activates or deactivates power output



12V max & 7.2V LITHIUM-ION

BATTERIES

12V max
LITHIUM-ION

BL1014



50 Minute Charge Time

12V max Lithium-Ion Battery

- Lithium-Ion battery delivers longer run time and lower self-discharge



7.2V
LITHIUM-ION

BL7010



50 Minute Charge Time

7.2V Lithium-Ion Battery

- 60-minute charge time when used with Makita's Lithium-Ion Charger (DC10WB)



CHARGER

12V max
LITHIUM-ION

DC10WB

7.2V - 12V max Lithium-Ion Charger

- Charges Makita 7.2V Lithium-Ion and 12V max Lithium-Ion batteries
- 50 minute charge time
- Compact size for easy storage and portability.

Also charges 10.8V Lithium-Ion batteries



36V LITHIUM-ION

36V
LITHIUM-ION

BL3626

2.6Ah BATTERY



30 Minute Charge Time

36V Lithium-Ion 2.6Ah Battery

- 30-minute charge time when used with Makita's Rapid Optimum Charger



36V
LITHIUM-ION

BL3622A

2.2Ah BATTERY



22 Minute Charge Time

36V Lithium-Ion Battery

- 60-minute charge time when used with Makita's Rapid Optimum Charger (DC36WA)



CHARGER

36V
LITHIUM-ION

DC36WA

36V Charger

- Charges Makita 36V Lithium-Ion Battery (BL3622A) in 60 minutes
- Compact design is ideal for job site portability and storage
- Compatible with 36V Lithium-Ion battery (BL3622A and BL3626)

Battery BL3622A must only be used with 36V Optimum Charger (DC36WA)





12V SELF-LEVEL CROSS-LINE

VERSATILITY

Selectable cross reference lines plus 4-point required for level, align, plumb & square applications

COMPATIBILITY

12V max CXT® battery delivers the convenience of a rechargeable tool battery



SK106GDNAX **SK106DNAX**

12V max CXT® Self-Leveling Cross-Line/4-Point Laser Kit

- Selectable horizontal/vertical cross reference lines plus 4-point required for level, align, plumb and square applications
- 12V max CXT® battery delivers the convenience of a rechargeable tool battery and up to 10 hours of continuous run time (SK106GDNAX)
- Green line visibility range up to 115' depending on ambient light and detectable up to 262' with Makita Laser Detector (SK106GDNAX)
- Red line visibility range up to 82' depending on ambient light and detectable up to 262' with Makita Laser Detector (SK106DNAX)
- Bright 525 nm class II green laser for best-in-class visibility with +/-1/8" at 33' for best-in-class accuracy (SK106GDNAX)
- Laser line fan angle spans past the 180° horizontal line and 170° vertical line positions for full reference line coverage
- Dust and water resistance with IP 54 rating for increased durability
- Rubberized housing over-mold for increased protection

SK106GDNAX Includes: 12V max CXT® Self-Leveling Cross-Line/4-Point Green Beam Laser (SK106GDZ), 12V max CXT® Lithium-Ion 2.0Ah Battery (BL1021B), 18V LXT® / 12V max CXT® Lithium-Ion Rapid Optimum Charger (DC18RE), Magnetic PRO L-Adapter (LE00870134), Magnetic Green Target Plate (LE00823195), Laser Kit Bag (832173-9)

SK106DNAX Includes: 12V max CXT® Self-Leveling Cross-Line/4-Point Red Beam Laser (SK106DZ), 12V max CXT® Lithium-Ion 2.0Ah Battery (BL1021B), 18V LXT® / 12V max CXT® Lithium-Ion Rapid Optimum Charger (DC18RE), Magnetic PRO L-Adapter (LE00870134), Magnetic Red Target Plate (LE00785638), Laser Kit Bag (832173-9)

Battery	12V max CXT® Lithium-Ion
Line accuracy (at 33')	+/- 1/8"
Point beam direction	4 point (up, down, left, right)
Line beam direction	2 line (horizontal, vertical)
Working range (line)	SK106DNAX (115'), SK105GDNAX (115')
Working Range with Detector:	262'
Operating time (hours):	SK106DNAX (20), SK106GDNAX (20)
Laser diode:	SK106DNAX (Class II, 510-530 nm), SK106GDNAX (Class II, 510-530 nm)
Levelling range	4°
Debris resistance	IP54 rating (dust & water resistance)
Auto shut off	No
Net Weight	1.9 lbs.
Shipping Weight	



SK106GDNAX shown

SK106DZ
SK106GDZ



Includes one battery



CXT LASER **SK105GDNAX / SK105DNAX** **SK105GDZ** **SK105DZ**

12V max CXT® Self-Leveling Cross-Line Laser Kit

- Selectable horizontal/vertical cross reference lines required for level, align and plumb applications
- 12V max CXT® battery delivers the convenience of a rechargeable tool battery and up to 10 hours of continuous run time (SK105GDNAX)
- Green line visibility range up to 115' depending on ambient light and detectable up to 262' with Makita Laser Detector (SK105GDNAX)

SK105GDNAX Includes: 12V max CXT® Self-Leveling Cross-Line Green Beam Laser (SK105GDZ), 12V max CXT® Lithium-Ion 2.0Ah Battery (BL1021B), 18V LXT® / 12V max CXT® Lithium-Ion Rapid Optimum Charger (DC18RE), Magnetic L-Adapter (LE00870131), Magnetic Green Target Plate (LE00823195), Laser Kit Bag (832173-9)

SK105DNAX Includes: 12V max CXT® Self-Leveling Cross-Line Red Beam Laser (SK105DZ), 12V max CXT® Lithium-Ion 2.0Ah Battery (BL1021B), 18V LXT® / 12V max CXT® Lithium-Ion Rapid Optimum Charger (DC18RE), Magnetic L-Adapter (LE00870131), Magnetic Red Target Plate (LE00785638), Laser Kit Bag (832173-9)

Battery	12V max CXT® Lithium-Ion
Line accuracy (at 33')	+/- 1/8"
Line beam direction	2 line (horizontal, vertical)
Working range (line):	SK105DNAX (115'), SK105GDNAX (115')
Working Range with Detector	262'
Operating time (hours):	SK105DNAX (20), SK105GDNAX (20)
Laser diode:	SK105DNAX (Class II, 510-530 nm), SK105GDNAX (Class II, 510-530 nm)
Levelling range	4°
Debris resistance	IP54 rating (dust & water resistance)
Auto shut off	No
Net Weight	1.9 lbs.
Shipping Weight	



CXT LASER **SK209GDZ**

12V max CXT® Self-Leveling Multi-Line/Point Green Beam Laser

- 12V max CXT® battery delivers the convenience of a rechargeable tool battery and up to 40 hours of continuous run time (battery not included)
- Selectable one horizontal, two vertical reference lines and plumb point required for level, align, plumb and square applications
- Best-in-class accuracy of +/-1/16" at 33'
- Fast self-leveling line stability is achieved in up to 3 seconds for increased productivity
- 360° rotating base with fine vertical line adjustment knob for increased accuracy
- Telescoping legs adjust to desired height providing stability over uneven surfaces or positioning over raised objects

SK209GDZ Includes: Green lens, Case, Case Strap, Case Lock Key

Battery	12V max CXT® Lithium-Ion
Line accuracy (at 33')	+/- 1/16"
Point beam direction	1 point (down)
Line beam direction	1 line (horizontal) 2 (vertical)
Working range (line)	50'
Working range (point)	100'
Working Range with Detector	65'
Operating time (hours)	40
Laser diode	Class II, 510-530 nm
Levelling range	2°
Auto shut off	No
Net Weight (with battery, sold separately)	3.3 lbs.
Shipping Weight	9.4 lbs.



LASER **SK103PZ**

Self-Leveling Combination Cross-Line/Point Laser

- Provides all possible reference lines required in leveling, aligning, plumbing, and squaring applications for maximum versatility
- Accuracy - horizontal/vertical lines (+/- 1/8" @ 30'); points (+/- 1/8" @ 30')
- Pendulum lock offers added protection of laser diode during transport and enables slope incline applications for increased versatility
- Laser line fan length spans well past 90° point position to provide 180° horizontal line and 120° vertical line
- Fast self-leveling time; stability is achieved in 3 seconds for increased productivity

SK103PZ Includes: Magnetic Mounting Adapter for Lasers (LE00789389), Magnetic Red Target Plate (LE00785638), Red Beam Target Card, Storage Pouch, Pouch Strap, (3) AA Batteries

Power supply (AA battery)	3
Line accuracy (at 33')	+/- 1/8"
Point beam direction	4 point (up, down, left, right)
Line beam direction	2 line (horizontal, vertical)
Working range (line)	50'
Working range (point)	100'
Laser diode	Class II, 635 nm
Levelling range	4°
Operating time (hours)	35
Auto shut off	Yes
Net Weight	1.04 lbs.
Shipping Weight	2.5 lbs.



LASER **SK104Z**

Self-Leveling Horizontal/Vertical Cross-Line Laser

- Accuracy - horizontal/vertical lines (+/- 1/8" @ 30')
- Pendulum lock offers added protection of laser diode during transport and enables slope incline applications for increased versatility
- Laser line fan length spans well past 90° position to provide 180° horizontal line and 120° vertical line
- Fast self-leveling time; stability is achieved in 3 seconds for increased productivity
- Line visibility range up to 50' depending on ambient light in working environment

SK104Z Includes: Magnetic Mounting Adapter for Lasers (LE00789389), Magnetic Red Target Plate (LE00785638), Red Beam Target Card, Storage Pouch, Pouch Strap, (3) AA Batteries

Power supply (AA battery)	3
Line accuracy (at 33')	+/- 1/8"
Line beam direction	2 line (horizontal, vertical)
Working range (line)	50'
Laser diode	Class II, 635 nm
Levelling range	4°
Operating time (hours)	35
Auto shut off	Yes
Net Weight	1.04 lbs.
Shipping Weight	2.4 lbs.



LASER **LD080P**

Laser Distance Measure, 262'

- Measuring distance operating range up to 262' for moderate distance capacity
- Provides top-class accuracy of +/- 1/16" for maximum precision
- Provides both standard and metric units of measurement
- Provides 9 measurement functions for increased versatility of applications
- Records history of 20 measurements for convenience
- Flip out end piece is designed to enable accurate readings from a corner or defined edge position

LD080P Includes: Carrying Pouch, Laser Strap, (2) AAA Batteries

Power supply (AAA battery)	2
Line accuracy (at 33')	+/- 1/16"
Working range	262'
Smallest unit of measure	1/32"
Laser diode	Class II, 635 nm
Historical memory	20
Auto shut off	Yes
Net Weight	.3 lbs.
Shipping Weight	.6 lbs.



LASER **LD050P**

Laser Distance Measure, 164'

- Measuring distance operating range up to 164' for moderate distance capacity
- Provides top-class accuracy of +/- 5/64" for maximum precision
- Provides 7 measurement functions for increased versatility of applications
- Provides both standard and metric units of measurement
- Records history of 5 measurements for convenience
- Simplified user interface button and screen for convenience

LD050P Includes: Carrying Pouch, Laser Strap, (2) AAA Batteries

Power supply (AAA battery)	2
Line accuracy (at 33')	+/- 5/64"
Working range	164'
Smallest unit of measure	1/16"
Laser diode	Class II, 635 nm
Historical memory	5
Auto shut off	Yes
Net Weight	.22 lbs.
Shipping Weight	.6 lbs.



XRH07PTU // 18V X2 LXT® (36V) BRUSHLESS 1-9/16" ADVANCED AVT® ROTARY HAMMER KIT, AWS™ (see pg. 54)

NEW XCV08PT // 18V X2 LXT® (36V) BRUSHLESS 2.1 GALLON HEPA FILTER DRY DUST EXTRACTOR/VACUUM KIT, AWS™ (see pg. 64)



ADVANTAGE

Advanced AVT® enhances Makita Anti-Vibration Technology (AVT®) with a 3-component system that sets new standards in vibration reduction, with no compromise in performance. The Air Actuated Counterbalance moves counterweight pistons in the opposite direction of the drive piston to actively reduce vibration. The Vibration Absorbing Housing isolates the rear and side handle, reducing vibration for the user. And the Integrated Damper Spring is engineered to absorb impact vibrations from the drill bit.

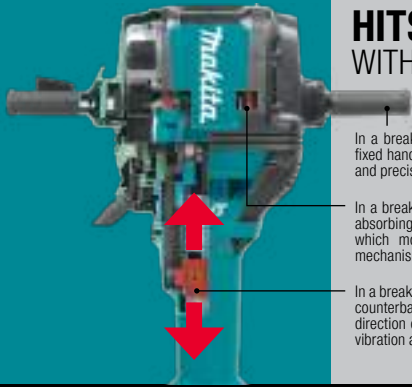

HITS LIKE AIR WITHOUT THE VIBRATION

In a breaker hammer, Advanced AVT® provides rubberized fixed handles which dampen vibration for increased comfort and precision

In a breaker hammer, Advanced AVT® provides a vibration-absorbing housing with a spring-loaded handle and housing which moves independently of the motor and hammer mechanism, effectively isolating vibration away from the user

In a breaker hammer, Advanced AVT® provides a mechanical counterbalance system which moves in the opposite direction of the hammer mechanism, which greatly reduces vibration and increases user comfort and productivity

AVT 3-COMPONENT SYSTEM



AIR ACTUATED COUNTERBALANCE



VIBRATION ABSORBING HOUSING



INTEGRATED DAMPER SPRING

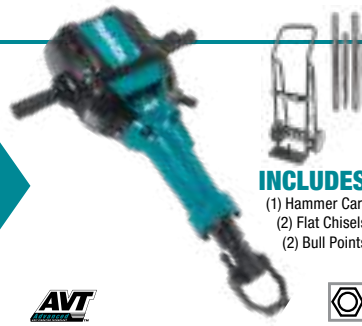

INCLUDES
(1) Hammer Cart
(2) Flat Chisels
(2) Bull Points



HM1812X3

70 lb. Advanced AVT® Breaker Hammer

- Efficient 15 AMP motor with improved hammer mechanism delivers 53.9 ft.lbs./72.8 joules of impact energy
- Advanced AVT® is a mechanical counterbalance, vibration absorbing housing and rubberized fixed handles designed to more effectively reduce vibration
- Soft start is designed to suppress start-up reaction for greater accuracy on start up
- L.E.D. light indicates electrical failure or notifies the user approximately 8 hours before brushes need to be replaced
- "Soft no-load" function automatically reduces the speed of the motor when not in use which helps increase tool life and performance
- Premium hammer cart transports breaker hammer and bits for increased convenience

HM1812X3 Includes: Hex Wrench (783203-8), (2) 1" x 20-1/2" Flat Chisel, 1-1/8" Hex (D-21369), (2) 16" Self Sharpening Bull Point, 1-1/8" Hex (B-45559), Premium Hammer Cart (T-03224)

AMPS	15
Blows Per Minute	870 BPM
Impact Energy (ft.lbs.)	53.9
Vibration Control	Yes
Vibration (m/s ²)	6.5
Noise Level	106 dB
Cord Length (ft)	16.4'
Overall Length	33-1/4"
Net Weight	69.1 lbs.
Shipping Weight	140 lbs.
Bit Type	1-1/8" Hex

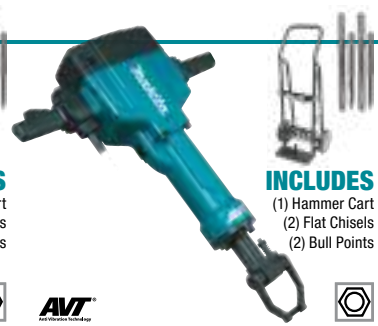

INCLUDES
(1) Hammer Cart
(2) Flat Chisels
(2) Bull Points



HM1810X3

70 lb. AVT® Breaker Hammer

- Efficient 15 AMP motor with improved hammer mechanism delivers 46.5 ft.lbs. of impact energy
- Anti-Vibration Technology is an internal counterbalance system that greatly reduces vibration
- Fixed movement handles for more control and better accuracy
- AC/DC switch for use with alternative power source
- L.E.D. power light indicates switch failure or cord damage
- Automatic brush cut-off protects commutator from damage for longer tool life

HM1810X3 Includes: Hex Wrench (783203-8), (2) 1" x 20-1/2" Flat Chisel, 1-1/8" Hex (D-21369), (2) 20-1/2" Bull Point, 1-1/8" Hex (D-21353), Premium Hammer Cart (T-03224)

AMPS	15
Blows Per Minute	1,100 BPM
Impact Energy (ft.lbs.)	46.5
Vibration Control	Yes
Vibration (m/s ²)	9
Noise Level	107 dB
Cord Length (ft)	16.4'
Overall Length	32-1/2"
Net Weight	71.3 lbs.
Shipping Weight	141.3 lbs.
Bit Type	1-1/8" Hex



HM1317CB

42 lb. AVT® Demolition Hammer

- Powerful 14 AMP motor delivers 25.7 ft.lbs. of impact energy to handle the most demanding applications
- Anti-Vibration Technology (AVT®) is an internal counterbalance system that greatly reduces vibration
- Constant speed control automatically applies additional power to the motor to maintain speed under load
- Variable speed control dial enables user to match the speed to the application for greater versatility
- L.E.D. service light notifies the user approximately 8 hours before the brushes need to be replaced
- L.E.D. power light indicates switch failure or cord damage

HM1317CB Includes: 20-1/2" Bull Point, 1-1/8" Hex (D-21353), Tool Case w/Wheels (824897-1)

AMPS	14
Blows Per Minute (variable speed)	730 - 1,450 BPM
Impact Energy (ft.lbs.)	25.7
Vibration Control	Yes
Vibration (m/s ²)	7
Noise Level	101 dB
Cord Length (ft)	16.4'
Overall Length	32-1/2"
Net Weight	41.9 lbs.
Shipping Weight	60.39 lbs.
Bit Type	1-1/8" Hex



HM1307CB

35 lb. Demolition Hammer

- Powerful 14 AMP motor delivers 25.7 ft.lbs. of impact energy to handle the most demanding applications
- Constant Speed Control automatically applies additional power to the motor to maintain consistent speed under load for the most challenging jobs
- Soft Start suppresses start-up reaction for smoother start-ups and better accuracy
- L.E.D. Service Light notifies the user approximately 8 hours before the brushes need to be replaced
- L.E.D. Power Lights indicate switch failure or cord damage
- Variable Speed control dial enables user to match the speed to the application for greater versatility

HM1307CB Includes: 20-1/2" Bull Point, 1-1/8" Hex (D-21353), Plastic Tool Case (824898-9)

AMPS	14
Blows Per Minute (variable speed)	730 - 1,450 BPM
Impact Energy (ft.lbs.)	25.7
Vibration Control	No
Vibration (m/s ²)	12
Noise Level	101 dB
Cord Length (ft)	16.4'
Overall Length	32-1/2"
Net Weight	38.2 lbs.
Shipping Weight	56.422 lbs.
Bit Type	1-1/8" Hex



HM1214C

27 lb. AVT® Demolition Hammer

- Powerful 14 AMP motor delivers 19 ft.lbs. of impact energy to handle the most demanding applications
- Anti-Vibration Technology is an internal counterbalance system that greatly reduces vibration
- Constant speed control automatically applies additional power to the motor to maintain speed under load
- Soft start suppresses start-up reaction for more precision and better accuracy
- Variable speed control dial enables user to match the speed to the application for greater versatility
- L.E.D. service light notifies the user approximately 8 hours before the brushes need to be replaced

HM1214C Includes: Side Handle (135283-4), 12" Bull Point, SDS-MAX (751423-A), Hammer Bit Grease (194683-7), Plastic Tool Case (824882-4)

AMPS	14
Blows Per Minute (variable speed)	950 - 1,900 BPM
Impact Energy (ft.lbs.)	19
Vibration Control	Yes
Vibration (m/s ²)	8
Noise Level	101 dB
Overall Length	27-1/2"
Net Weight	27.1 lbs.
Shipping Weight	46.284 lbs.
Bit Type	Accepts SDS-MAX



HM1203C

20 lb. Demolition Hammer

- Powerful 14 AMP motor delivers 18.8 ft.lbs. of impact energy to handle the most demanding applications
- Constant speed control automatically applies additional power to the motor to maintain speed under load to complete the most challenging jobs
- Variable speed control dial enables user to match the speed to the application for greater versatility
- Soft start suppresses start-up reaction for precision and better accuracy
- L.E.D. service light notifies the user approximately 8 hours before the brushes need to be replaced
- L.E.D. power light indicates switch failure or cord damage

HM1203C Includes: 12" Bull Point, SDS-MAX (751423-A), Hammer Bit Grease (194683-7), CLOTH F/WIPING OIL (443122-7), (135269-8), Plastic Tool Case (824876-9)

AMPS	14
Blows Per Minute (variable speed)	950 - 1,900 BPM
Impact Energy (ft.lbs.)	18.8
Vibration Control	No
Vibration (m/s ²)	15.5
Noise Level	95 dB
Overall Length	22-3/4"
Net Weight	20.3 lbs.
Shipping Weight	36 lbs.
Bit Type	Accepts SDS-MAX



HM1211B

20 lb. Demolition Hammer

- Powerful 10 AMP motor for faster and efficient operation
- Comfortable rubber D-shaped grip side handle absorbs vibration; secures in four positions for operator comfort
- One-touch tool retainer action for easy accessory installation and removal
- Automatic brush cut-off protects commutator from damage for longer tool life
- Accepts 3/4" Hex Shank bits
- AC/DC switch for use with alternative power source

HM1211B Includes: Hex Wrench (783202-0), Tool Case (150589-9)

AMPS	10
Blows Per Minute	2,000 BPM
Impact Energy (ft.lbs.)	10.5
Vibration Control	No
Vibration (m/s ²)	25
Noise Level	96 dB
Overall Length	19-5/16"
Net Weight	20.7 lbs.
Shipping Weight	33 lbs.
Bit Type	3/4" Hex - 21/32" Round



HM1111C

17 lb. AVT® Demolition Hammer

- Powerful 14 AMP motor delivers 12.7 ft.lbs. of impact energy to handle the most demanding applications
- Anti-Vibration Technology is an internal counterbalance system that greatly reduces vibration for increased user comfort and greater productivity
- Detached rear handle is spring loaded to provide less vibration and more control
- Constant speed control automatically applies additional power to the motor to maintain speed under load to complete the most challenging jobs
- Soft start suppresses start-up reaction for more control and better accuracy
- Variable speed control dial enables user to match the speed to the application for greater versatility

HM1111C Includes: Side Handle (151769-0), Hammer Bit Grease (194683-7), CLOTH F/WIPING OIL (443122-7), 12" Bull Point, SDS-MAX (751423-A), Plastic Case

AMPS	14
Blows Per Minute (variable speed)	1,100 - 2,650 BPM
Impact Energy (ft.lbs.)	12.7
Vibration Control	Yes
Vibration (m/s ²)	8
Noise Level	99 dB
Overall Length	20-3/4"
Net Weight	17.7 lbs.
Shipping Weight	28.6 lbs.
Bit Type	Accepts SDS-MAX



HM0870C

11 lb. Demolition Hammer

- Powerful 10 AMP motor delivers 8.4 ft.lbs. of impact energy to handle the most demanding applications
- Constant speed control automatically applies additional power to the motor to maintain speed under load to complete the most challenging jobs
- Soft start suppresses start-up reaction for better accuracy
- L.E.D. service light notifies the user approximately 8 hours before the brushes need to be replaced
- L.E.D. power light indicates switch failure or cord damage
- Variable speed control dial enables user to match the speed to the application for greater versatility

HM0870C Includes: Hammer Bit Grease (194683-7), Tool Case (824905-8), CLOTH F/WIPING OIL (443122-7)

AMPS	10
Blows Per Minute (variable speed)	1,100 - 2,650 BPM
Impact Energy (ft.lbs.)	8.4
Vibration Control	No
Vibration (m/s ²)	11
Noise Level	98 dB
Overall Length	17-3/4"
Net Weight	11.1 lbs.
Shipping Weight	18.5 lbs.
Bit Type	Accepts SDS-MAX



HM0810B

13 lb. Demolition Hammer

- Soft rubber grip side handle minimizes vibration and swivels 360° for operator convenience
- Lock-on button for continuous use
- Innovative anti-vibration spring is positioned between tool body and rear handle for reduced operator fatigue
- One-touch tool retainer action for easy accessory installation and removal
- Makita Motor Advantage engineered for more power and longer tool life
- Extended life brushes are longer for more work between service intervals and less downtime

HM0810B Includes: Hex Wrench (783202-0), Tool Case (150589-9)

AMPS	8.3
Blows Per Minute	2,900 BPM
Impact Energy (ft.lbs.)	5.6
Vibration Control	No
Vibration (m/s ²)	15
Noise Level	94 dB
Overall Length	16-5/8"
Net Weight	13.4 lbs.
Shipping Weight	19.4 lbs.
Bit Type	3/4" Hex - 21/32" Round



HK1810

Power Scraper

- Air cushion hammering for longer tool life
- Quick change bit retainer for easy changes
- Automatic brush cut-off protects commutator from damage
- Factory grease packed for reduced maintenance
- All-ball bearing construction for longer tool life
- Accepts Makita Small bits

HK1810 Includes: 1-3/16" x 6" Scaling Chisel, Makita Small Shank (B-07331), 2" x 6" Scaling Chisel, Makita Small Shank (B-07347), 8-3/4" Bull Point, Makita Small Shank (B-06921), Dust Cover (423154-0), Tool Case (150640-5)

AMPS	4.5
Blows Per Minute (variable speed)	0 - 3,200 BPM
Impact Energy (ft.lbs.)	2.9
Vibration Control	No
Vibration (m/s ²)	13.5
Noise Level	93 dB
Overall Length	12-3/8"
Net Weight	7.1 lbs.
Shipping Weight	13.7 lbs.
Bit Type	Makita small



HR5212C

2" Advanced AVT® Rotary Hammer

- Powerful 15 AMP motor delivers 14 ft.lbs. / 19 J. of impact energy
- Advanced AVT® is an air actuated counterbalance, vibration absorbing housing and impact bolt dumper spring that more effectively reduces vibration
- Electronic Controller is a feature package that provides constant speed control, soft start, soft no-load and variable speed
- L.E.D. light indicates electrical failure or notifies the user when brushes need to be replaced
- Torque limiting clutch engineered to prevent gear damage
- Lock-on or trigger activation in "Chipping Only" mode with a push button start/stop control for more convenient operation

HR5212C Includes: DEPTH ROD, HR4013C (331955-1), Hammer Bit Grease (194683-7), CLOTH F/WIPING OIL (443122-7), D-handle (417003-1), Straight Handle (454781-2) (454781-2), Straight Handle Assembly (135629-4) (135629-4), Accessory Case (0000)

AMPS	15
Max. Capacity (concrete drilling)	2"
Optimum Range (concrete drilling)	3/4" - 1-9/16"
Max. Capacity (concrete drilling w/ core bit)	6-1/4"
Impact Energy (ft.lbs.)	14
Blows Per Minute (variable speed)	1,100 - 2,250 BPM
No Load Speed (variable speed)	130 - 260 RPM
Vibration Control	Yes
Vibration (m/s ²)	9
Overall Length	23-1/2"
Cord Length (ft)	16.4'
Net Weight	26.2 lbs.
Shipping Weight	42 lbs.
Bit Type	Accepts SDS-MAX



HR5000

2" Rotary Hammer

- All ball-and-needle bearing construction for longer tool life
- Powerful 11 AMP motor for the most demanding applications
- Built-in clutch reduces gear damage by disengaging gears if the bit binds
- 2-mode operation for "Hammering Only" or "Hammering with Rotation" for multiple applications
- Sequential impact timing delivers timed hammering during rotation to minimize overlapping bit impacts resulting in up to 50% faster drilling
- Makita Motor Advantage engineered for more power and longer tool life

HR5000 Includes: Hex Wrench (783202-0), Hex Wrench (783203-8), Wrench (783204-6), Tool Case (150589-9)

AMPS	11
Max. Capacity (concrete drilling)	2"
Optimum Range (concrete drilling)	5/8" - 1-3/8"
Max. Capacity (concrete drilling w/ core bit)	5-7/8"
Impact Energy (ft.lbs.)	8.7
Blows Per Minute	2,100 BPM
No Load Speed	260 RPM
Vibration Control	No
Vibration (m/s ²)	25
Overall Length	18-3/4"
Cord Length (ft)	8.2'
Net Weight	21.8 lbs.
Shipping Weight	35 lbs.
Bit Type	Accepts Spline Shank



HR4510C

1-3/4" AVT® Rotary Hammer

- Powerful 13.5 AMP motor delivers 9.2 ft.lbs. of impact energy to handle the most demanding applications
- Constant speed control automatically applies additional power to the motor to maintain speed under load to complete the most challenging jobs
- Soft start suppresses start-up reaction for increased accuracy
- L.E.D. service light notifies the user approximately 8 hours before the brushes need to be replaced
- L.E.D. power lights indicate switch failure or cord damage
- Anti-Vibration Technology is an internal counterbalance system that greatly reduces vibration

HR4510C Includes: Side Handle (151769-0), D-handle (417003-1), Depth Gauge (321248-4), Hammer Bit Grease (194683-7), Plastic Tool Case (158275-6)

AMPS	13.5
Max. Capacity (concrete drilling)	1-3/4"
Optimum Range (concrete drilling)	3/4" - 1-3/8"
Max. Capacity (concrete drilling w/ core bit)	5"
Impact Energy (ft.lbs.)	9.2
Blows Per Minute (variable speed)	1,250 - 2,750 BPM
No Load Speed (variable speed)	130 - 280 RPM
Vibration Control	Yes
Vibration (m/s ²)	9.5
Overall Length	18"
Cord Length (ft)	16.4'
Net Weight	19.6 lbs.
Shipping Weight	35 lbs.
Bit Type	Accepts SDS-MAX

DUST EXTRACTION DRILL BITS

DUST MANAGEMENT

Features dust extraction holes for removal of dust from the hole while drilling

DESIGN

Dust evacuation increases drilling speed and improves drill bit life

PRODUCTIVITY

Reduces airborne silica dust and offers increased productivity during chemical anchor installation

COMPATIBILITY

Fits most common dust extractor vacuums



SEE MORE // pg.135



10-CUTTER

6/4/6 solid carbide head design provides 10 cutting edges for added durability in concrete and reinforced concrete drilling applications



3-CUTTER

3 cutting edges for maximum performance, rebar resistance and more accurate holes



LXT BRUSHLESS **AVT**
XRH07PTU **XRH07ZKU**

18V X2 LXT® (36V) Brushless 1-9/16" Advanced AVT® Rotary Hammer Kit, AWS™

- Two 18V LXT™ Lithium-Ion batteries deliver the power and run time for corded demands without leaving the 18V LXT™ platform
- Powerful BL™ Brushless motor delivers 250-500 RPM, 1,450-2,900 BPM and 8.4 ft.lbs. of impact energy to handle the most demanding applications
- Auto-start Wireless System (AWS™) utilizes Bluetooth® technology for wireless power-on/off communication between tool and dust extractor

XRH07PTU Includes: 18V X2 LXT™ (36V) Brushless 1-9/16" Advanced AVT® Rotary Hammer, AWS™ (XRH07ZKU), (2) 18V LXT™ Lithium-Ion 5.0Ah Battery (BL1850B), 18V LXT™ Lithium-Ion Dual Port Charger (DC18RD), Auto-Start Wireless Transmitter (198901-5), Side Handle Assembly, Depth Rod, Bit Grease, Tool Case

XRH07ZKU Includes: Tool only, battery & charger not included Auto-Start Wireless Transmitter (198901-5), Side Handle Assembly, Depth Rod, Bit Grease, Tool Case

Max. Capacity (concrete drilling)	1-9/16"
Optimum Range (concrete drilling)	5/8" - 1-1/4"
Max. Capacity (concrete drilling w/ core bit)	4-1/8"
Impact Energy (ft.lbs.)	8.4
Impact Energy (Joules)	11.4 J
Blows Per Minute (variable speed)	1,450 - 2,900 BPM
No Load Speed (variable speed)	250 - 500 RPM
Vibration Control	Yes
Vibration (m/s²)	5
Battery	2X 18V LXT™ Lithium-Ion
Overall Length	18-5/8"
Net Weight	16.8 lbs.
Bit Type	Accepts SDS-MAX



AVT
HR4013C

1-9/16" Advanced AVT® Rotary Hammer

- Powerful 11 AMP motor delivers 8.4 ft.lbs. / 11.4 J. of impact energy to handle the most demanding applications
- Advanced AVT™ is an air actuated counterbalance, vibration absorbing housing and impact bolt dumper spring that more effectively reduces vibration
- Electronic Controller is a feature package that provides constant speed control, soft start, soft no-load and variable speed
- L.E.D. light indicates electrical failure or notifies the user approximately 8 hours before brushes need to be replaced
- Torque limiting clutch engineered to prevent gear damage by automatically disengaging gears if the bit binds

HR4013C Includes: D-Handle Assembly, HR4013C (196792-8), DEPTH ROD, HR4013C (331955-1), Side Handle Assembly (123138-5), Hammer Bit Grease (194683-7), CLOTH F/WIPING OIL (443122-7), Tool Case (141977-1)

AMPS	11
Max. Capacity (concrete drilling)	1-9/16"
Optimum Range (concrete drilling)	5/8" - 1-1/4"
Max. Capacity (concrete drilling w/ core bit)	4-1/8"
Impact Energy (ft.lbs.)	8.4
Blows Per Minute (variable speed)	1,450 - 2,900 BPM
No Load Speed (variable speed)	250 - 500 RPM
Vibration Control	Yes
Vibration (m/s²)	5
Overall Length	18-11/16"
Cord Length (ft)	15.6'
Net Weight	15.1 lbs.
Shipping Weight	27.8 lbs.
Bit Type	Accepts SDS-MAX



HR4002

1-9/16" Rotary Hammer

- Powerful 10 AMP motor delivers 4.6 ft.lbs. of impact energy
- 2-mode operation for "Hammering Only" or "Hammering with Rotation"
- Rubberized ergonomic soft grip provides more comfort
- "No hammering when idling" functions helps increase tool life
- One-touch sliding chuck for quick bit changes
- Torque limiting clutch engineered to prevent gear damage by automatically disengaging gears if the bit binds

HR4002 Includes: Depth Gauge (321248-4), Hammer Bit Grease (194683-7), Plastic Tool Case (158275-6)

AMPS	10
Max. Capacity (concrete drilling)	1-9/16"
Optimum Range (concrete drilling)	1/2" - 1"
Max. Capacity (concrete drilling w/ core bit)	4-1/8"
Impact Energy (ft.lbs.)	4.6
Blows Per Minute	2,500 BPM
No Load Speed	680 RPM
Vibration Control	No
Vibration (m/s²)	17.5
Overall Length	18"
Cord Length (ft)	9.8'
Net Weight	14.6 lbs.
Shipping Weight	26.89 lbs.
Bit Type	Accepts SDS-MAX



HR4041C

1-9/16" Rotary Hammer

- Powerful 11 AMP motor delivers 6.8 ft.lbs. of impact energy
- Constant speed control automatically applies additional power to the motor to maintain speed under load
- Soft start suppresses start-up reaction for increased accuracy
- Variable speed control dial enables user to match the speed to the application
- One-touch tool retainer action for easy accessory installation and removal
- "No hammering while idling" helps increase tool life

HR4041C Includes: Side Handle (416549-4), Depth Gauge (321248-4), Tool Case (1582578)

AMPS	11
Max. Capacity (concrete drilling)	1-9/16"
Optimum Range (concrete drilling)	1/2" - 1"
Max. Capacity (concrete drilling w/ core bit)	4-5/8"
Impact Energy (ft.lbs.)	6.8
Blows Per Minute (variable speed)	1,300 - 2,600 BPM
No Load Speed (variable speed)	230 - 460 RPM
Vibration Control	No
Vibration (m/s²)	15
Overall Length	16-7/8"
Cord Length (ft)	16.4'
Net Weight	14.8 lbs.
Shipping Weight	20.3 lbs.
Bit Type	Accepts Spine shank



HR3210C

1-1/4" AVT® Rotary Hammer

- Powerful 8.2 AMP motor delivers 4.7 ft.lbs. of impact energy
- Anti-Vibration Technology (AVT™) is an internal counterbalance system that greatly reduces vibration
- Torque limiting clutch engineered to prevent gear damage by automatically disengaging gears
- Constant speed control automatically applies additional power to the motor to maintain speed under load
- Soft start suppresses start-up reaction for more precision and better accuracy
- L.E.D. light indicates electrical failure or notifies the user approximately 8 hours before brushes need to be replaced

HR3210C Includes: 1/4" x 6" SDS-PLUS Bit, 2-Cutter (B-60610), 1/4" x 6" SDS-PLUS Bit, 2-Cutter, 10/Pk (B-60894), 5 Pc. SDS-PLUS Bit Set, 2-Cutter (B-60969), 3/16" x 6" SDS-PLUS Bit, 3-Cutter (B-60981), 1/4" x 6" SDS-PLUS Bit, 3-Cutter (B-61020), 3/16" x 6" SDS-PLUS Bit, 3-Cutter, 10/Pk (B-61189), 1/4" x 6" SDS-PLUS Bit, 3-Cutter, 10/Pk (B-61210), 5 Pc. SDS-PLUS Bit Set, 3-Cutter (B-61298), Side Handle (151769-0), Depth Gauge (321248-4), Tool Case (824825-6), Hammer Bit Grease (194683-7)

AMPS	8.2
Max. Capacity (concrete drilling)	1-1/4"
Optimum Range (concrete drilling)	1/2" - 7/8"
Max. Capacity (concrete drilling w/ core bit)	3-1/2"
Impact Energy (ft.lbs.)	4.1
Blows Per Minute (variable speed)	1,650 - 3,300 BPM
No Load Speed (variable speed)	315 - 630 RPM
Vibration Control	Yes
Vibration (m/s²)	10
Overall Length	15-5/8"
Cord Length (ft)	16.4'
Net Weight	11.4 lbs.
Shipping Weight	19.84 lbs.
Bit Type	Accepts SDS-PLUS



HR2811F

1-1/8" Rotary Hammer

- Powerful 7.0 AMP motor delivers 2.1 ft.lbs. of impact energy
- Vibration-absorbing back handle for operator comfort
- L.E.D. light illuminates drilling surface for more productivity in low light applications
- 3-mode operation for "Rotation Only", "Hammering with Rotation" or "Hammering Only"
- "No hammering when idling" function helps increase tool life

HR2811F Includes: Depth Gauge (324219-0), Plastic Tool Case (824789-4), Side Handle (154842-5)

AMPS	7
Max. Capacity (concrete drilling)	1-1/8"
Optimum Range (concrete drilling)	1/4" - 5/8"
Max. Capacity (concrete drilling w/ core bit)	3-1/8"
Impact Energy (ft.lbs.)	2.1
Blows Per Minute (variable speed)	0 - 4,500 BPM
No Load Speed (variable speed)	0 - 1,100 RPM
Vibration Control	No
Vibration (m/s²)	15
Overall Length	12-5/8"
Cord Length (ft)	8.2'
Net Weight	7.7 lbs.
Shipping Weight	11.8 lbs.
Bit Type	Accepts SDS-PLUS

ANTI-VIBRATION TECHNOLOGY-AVT®

BL™ AND AVT® DELIVER HIGH POWER AND LOW VIBRATION

PERFORMANCE

X2 LXT® technology delivers up to 140 1/2" x 2-3/8" holes per charge using two 18V 5.0Ah batteries

DUST MANAGEMENT

OSHA Table 1 compliant on-board dust extractor has a filter cleaning mechanism for optimum suction



XRH10PTW

XRH10ZW

18V X2 LXT® 36V Brushless 1-1/8" AVT® Rotary Hammer Kit, AFT®, AWS™ Capable

- X2 LXT® technology delivers up to 140 1/2" x 2-3/8" holes per charge using two 18V LXT® 5.0Ah batteries
- Powerful BL™ Brushless motor delivers 0-980 RPM, 0-5,000 BPM and 2.3 ft.lbs. of impact energy to handle the most demanding applications
- OSHA Table 1 compliant on-board dust extractor includes a filter cleaning mechanism designed to help maintain optimum suction efficiency
- Active Feedback-Sensing Technology (AFT®) electronically turns off the motor if rotation of bit is suddenly forced to stop
- Auto-Start Wireless System (AWS™) which utilizes Bluetooth® technology for wireless power-on/off communication between tool and dust extractor
- AWS™ capable with Auto-Start Wireless Transmitter (part no. 198901-5) sold separately
- AVT® is an active internal counterbalance system and vibration-absorbing back handle that are engineered to reduce vibration for increased comfort
- Constant speed control automatically applies additional power to the motor to maintain speed under load to complete the most challenging jobs

XRH10PTW Includes: 18V X2 LXT® (36V) Brushless 1-1/8" AVT® Rotary Hammer, AFT® AWS™ Capable (XRH10Z), Dust Extractor Attachment with HEPA Filter Cleaning Mechanism (DX08), (2) 18V LXT® Lithium-Ion 5.0Ah Battery (BL1850B), 18V LXT® Lithium-Ion Dual Port Charger (DC18RD), Dust Case with HEPA Filter Cleaning Mechanism (199588-6), Side Handle, Depth Gauge, Tool Bag

XRH10ZW Includes: Tool only, battery & charger not included Dust Extractor Attachment with HEPA Filter Cleaning Mechanism (DX08), Side Handle, Depth Gauge

Max. Capacity (concrete drilling)	1-1/8"
Optimum Range (concrete drilling)	3/16" - 5/8"
Max. Capacity (concrete drilling w/ core bit)	2-1/8"
Impact Energy (ft.lbs.)	2.3
Impact Energy (Joules)	3.2 J
Blows Per Minute (variable speed)	0 - 5,000 BPM
No Load Speed (variable speed)	0 - 980 RPM
HEPA filter	Yes
Vibration Control	Yes
Vibration (m/s²)	9
Battery	2X 18V LXT® Lithium-Ion
Overall Length	14-3/4"
Net Weight (with battery)	11 lbs.
Bit Type	Accepts SDS-PLUS
Shipping Weight	23.02 lbs.



XRH10Z

18V X2 LXT® (36V) Brushless 1-1/8" AVT® Rotary Hammer, AFT®, AWS™ Capable

- X2 LXT® technology delivers up to 140 1/2" x 2-3/8" holes per charge using two 18V LXT® 5.0Ah batteries (batteries not included)
- Powerful BL™ Brushless motor delivers 0-980 RPM, 0-5,000 BPM and 2.3 ft.lbs. of impact energy to handle the most demanding applications
- Dust extraction capability with optional OSHA Table 1 compliant On-Board Dust Extractor Attachment
- Active Feedback-Sensing Technology (AFT®) electronically turns off the motor if rotation of bit is suddenly forced to stop
- Auto-Start Wireless System (AWS™) which utilizes Bluetooth® technology for wireless power-on/off communication between tool and dust extractor

XRH10Z Includes: Tool only, battery & charger not included Side Handle, Depth Gauge

Max. Capacity (concrete drilling)	1-1/8"
Optimum Range (concrete drilling)	3/16" - 5/8"
Max. Capacity (concrete drilling w/ core bit)	2-1/8"
Impact Energy (ft.lbs.)	2.3
Impact Energy (Joules)	3.2 J
Blows Per Minute (variable speed)	0 - 5,000 BPM
No Load Speed (variable speed)	0 - 980 RPM
Vibration Control	Yes
Vibration (m/s²)	9
Battery	2X 18V LXT® Lithium-Ion
Overall Length	14-3/4"
Net Weight (with battery)	9.9 lbs.
Bit Type	Accepts SDS-PLUS



XRH11Z

18V X2 LXT® (36V) Brushless 1-1/8" AVT® Rotary Hammer, AFT®, AWS™ Capable

- X2 LXT® technology delivers up to 140 1/2" x 2-3/8" holes per charge using two 18V LXT® 5.0Ah batteries (batteries not included)
- Powerful BL™ Brushless motor delivers 0-980 RPM, 0-5,000 BPM and 2.3 ft.lbs. of impact energy to handle the most demanding applications
- Dust extraction capability with optional OSHA Table 1 compliant on-board Dust Extractor Attachment
- Auto-Start Wireless System (AWS™) which utilizes Bluetooth® technology for wireless power-on/off communication between tool and dust extractor
- AWS™ capable with Auto-Start Wireless Transmitter (part no. 198901-5) sold separately

XRH11Z Includes: Tool only, battery & charger not included Quick Change 1/2" Keyless Chuck (199135-3), Side Handle, Depth Gauge

Max. Capacity (concrete drilling)	1-1/8"
Optimum Range (concrete drilling)	3/16" - 5/8"
Max. Capacity (concrete drilling w/ core bit)	2-1/8"
Impact Energy (ft.lbs.)	2.3
Impact Energy (Joules)	3.2 J
Blows Per Minute (variable speed)	0 - 5,000 BPM
No Load Speed (variable speed)	0 - 980 RPM
Vibration Control	Yes
Vibration (m/s²)	9.5
Battery	2X 18V LXT® Lithium-Ion
Overall Length	15-7/8"
Net Weight (with battery)	11.2 lbs.
Bit Type	Accepts SDS-PLUS
Shipping Weight	10.6 lbs.



XRH08PTW

XRH08Z

18V X2 LXT® 36V Brushless 1-1/8" AVT® Rotary Hammer Kit w/ HEPA Dust Extractor

- X2 LXT® technology delivers up to 140 1/2" x 2-3/8" holes per charge using two 18V LXT® 5.0Ah batteries
- Powerful BL™ Brushless motor delivers 0-980 RPM, 0-5,000 BPM and 2.3 ft.lbs. of impact energy to handle the most demanding applications
- OSHA Table 1 compliant on-board dust extractor includes a filter cleaning mechanism designed to help maintain optimum suction efficiency
- AVT® is an active internal counterbalance system and vibration-absorbing back handle that are engineered to reduce vibration for increased comfort

XRH08PTW Includes: 18V X2 LXT® (36V) Brushless 1-1/8" AVT® Rotary Hammer (XRH08Z), Dust Extractor Attachment with HEPA Filter Cleaning Mechanism (DX08), (2) 18V LXT® Lithium-Ion 5.0Ah Battery (BL1850B), 18V LXT® Lithium-Ion Dual Port Charger (DC18RD), Dust Case with HEPA Filter Cleaning Mechanism (199588-6), Side Handle, Depth Gauge, Tool Bag

XRH08Z Includes: Tool only, battery & charger not included Side Handle, Depth Gauge

Max. Capacity (concrete drilling)	1-1/8"
Optimum Range (concrete drilling)	3/16" - 5/8"
Max. Capacity (concrete drilling w/ core bit)	2-1/8"
Impact Energy (ft.lbs.)	2.3
Impact Energy (Joules)	3.2 J
Blows Per Minute (variable speed)	0 - 5,000 BPM
No Load Speed (variable speed)	0 - 980 RPM
HEPA filter	Yes
Container Hole Count Capacity	25 holes of dimension 5/8" x 2"
Filter Life (Approx. container fillings)	200
Vibration Control	Yes
Vibration (m/s²)	9
Battery	2X 18V LXT® Lithium-Ion
Overall Length	14-3/4"
Net Weight (with battery)	10.8 lbs.
Bit Type	Accepts SDS-PLUS
Shipping Weight	23.02 lbs.



XRH08PT

XRH08Z

18V X2 LXT® (36V) Brushless 1-1/8" AVT® Rotary Hammer Kit

- X2 LXT® technology delivers up to 140 1/2" x 2-3/8" holes per charge using two 18V LXT® 5.0Ah batteries
- Powerful BL™ Brushless motor delivers 0-980 RPM, 0-5,000 BPM and 2.3 ft.lbs. of impact energy to handle the most demanding applications
- Dust extraction capability with optional OSHA Table 1 compliant On-Board Dust Extractor Attachment
- AVT® is an active internal counterbalance system and vibration-absorbing back handle that are engineered to reduce vibration for increased comfort

XRH08PT Includes: 18V X2 LXT® (36V) Brushless 1-1/8" AVT® Rotary Hammer (XRH08Z), (2) 18V LXT® Lithium-Ion 5.0Ah Battery (BL1850B), 18V LXT® Lithium-Ion Dual Port Charger (DC18RD), Side Handle, Depth Gauge, Tool Bag

XRH08Z Includes: Tool only, battery & charger not included Side Handle, Depth Gauge

Max. Capacity (concrete drilling)	1-1/8"
Optimum Range (concrete drilling)	3/16" - 5/8"
Max. Capacity (concrete drilling w/ core bit)	2-1/8"
Impact Energy (ft.lbs.)	2.3
Impact Energy (Joules)	3.2 J
Blows Per Minute (variable speed)	0 - 5,000 BPM
No Load Speed (variable speed)	0 - 980 RPM
Vibration Control	Yes
Vibration (m/s²)	9
Battery	2X 18V LXT® Lithium-Ion
Overall Length	14-3/4"
Net Weight (with battery)	10.8 lbs.
Bit Type	Accepts SDS-PLUS



XRH05PT

XRH05Z

18V X2 LXT® (36V) 1" Rotary Hammer Kit

- Two 18V LXT® Lithium-Ion batteries deliver the power and run time for corded demands without leaving the 18V LXT® platform
- Makita-built motor delivers 0-1,250 RPM, 0-5,000 BPM and 2.2 ft.lbs. of impact energy for faster drilling
- Vibration-absorbing handle engineered for increased operator comfort
- Dust extraction capability with Makita Dust Attachment, #193472-7 (not included)
- Torque limiting clutch engineered to prevent gear damage by automatically disengaging gears if the bit binds

XRH05PT Includes: 18V X2 LXT® (36V) 1" Rotary Hammer (XRH05Z), (2) 18V LXT® Lithium-Ion 5.0Ah Battery (BL1850B), 18V LXT® Lithium-Ion Dual Port Charger (DC18RD), Side Handle (450990-1), Depth Gauge (324219-0), 20" Contractor Tool Bag (831303-9)

XRH05Z Includes: Tool only, battery & charger not included Side Handle (450990-1), Depth Gauge (324219-0), Tool Bag (831271-6)

Max. Capacity (concrete drilling)	1"
Optimum Range (concrete drilling)	3/16" - 5/8"
Impact Energy (ft.lbs.)	2.2
Impact Energy (Joules)	3 J
Blows Per Minute (variable speed)	0 - 5,000 BPM
No Load Speed (variable speed)	0 - 1,250 RPM
Vibration Control	No
Vibration (m/s²)	14.5
Battery	2X 18V LXT® Lithium-Ion
Overall Length	13-3/4"
Net Weight (with battery)	9.3 lbs.
Shipping Weight	26.2 lbs.
Bit Type	Accepts SDS-PLUS



HR2641

1" AVT® Rotary Hammer

- Powerful 8 AMP motor delivers 2.1 ft.lbs. of impact energy to handle the most demanding applications
- Anti-Vibration Technology (AVT®) is an internal counterbalance system that greatly reduces vibration
- Torque limiting clutch engineered to prevent gear damage by automatically disengaging gears if the bit binds
- Ergonomic "D-shaped" handle with rubberized soft grip for increased comfort
- Recessed hammer function selector provides 3-mode operation for "Rotation Only", "Hammering with Rotation" or "Chipping" for multiple applications

HR2641 Includes: Side Handle (451749-9), Depth Gauge (331886-4), Tool Case (824695-3)

AMPS	8
Max. Capacity (concrete drilling)	1"
Optimum Range (concrete drilling)	1/4" - 5/8"
Max. Capacity (concrete drilling w/ core bit)	3-1/8"
Impact Energy (ft.lbs.)	2.1
Blows Per Minute (variable speed)	0 - 4,500 BPM
No Load Speed (variable speed)	0 - 1,100 RPM
Vibration Control	Yes
Vibration (m/s²)	11.5
Overall Length	16-5/8"
Cord Length (ft)	13'1"
Net Weight	7.1 lbs.
Shipping Weight	11.5 lbs.
Bit Type	Accepts SDS-PLUS



AVT **HEPA filter**

HR2661

1" AVT® Rotary Hammer w/ HEPA Dust Extractor

- Powerful 8 AMP motor delivers 1.6 ft.lbs./2.2 J. of impact energy to handle the most demanding applications
- Anti-Vibration Technology (AVT®) is an internal counterbalance system that actively works to reduce vibration to the operator
- On-board dust extractor captures concrete dust during drilling and is activated by the tool for operator convenience
- Efficient HEPA filtration system captures 99.97% of particulates .3 microns and larger
- Transparent dust container provides needed visibility in determining when the dust box needs to be emptied
- Torque limiting clutch engineered to prevent gear damage by automatically disengaging gears if the bit binds

HR2661 Includes: Dust Extractor Attachment with HEPA Filter (135905-6), (6) Sealing Cap (424474-5), Side Handle, Depth Rod, Tool Case

AMPS	8
Max. Capacity (concrete drilling)	1"
Optimum Range (concrete drilling)	1/4" - 5/8"
Max. Hole Depth	7-7/16"
Max. Capacity (concrete drilling w/ core bit)	3-1/8"
Impact Energy (Joules)	2.2 J
Blows Per Minute (variable speed)	0 - 4,500 BPM
No Load Speed (variable speed)	0 - 1,100 RPM
HEPA filter	Yes
Container Hole Count Capacity	36 holes of dimension 3/8"x2-3/8"
Filter Life (Approx. container fillings)	200
Vibration Control	Yes
Vibration (m/s ²)	9.5
Sound Rating (decibels)	90 dB(A)



LXT BRUSHLESS

XRH011TX **XRH01ZX**

18V LXT® Brushless 1" Rotary Hammer Kit, w/ HEPA Dust Extractor

- Powerful BL™ Brushless motor delivers 0-950 RPM, 0-4,700 BPM and 1.7 ft.lbs. of impact energy to handle the most demanding applications
 - The on-board dust extractor attachment captures concrete dust during drilling and is activated by the tool for operator convenience
 - Extractor is powered by a separate motor to maintain drilling performance and provide a 2-second delay to help capture remaining dust
 - Efficient HEPA filtration system captures 99.97% of particulates .3 microns and larger
- XRH011TX Includes:** 18V LXT® Brushless 1" Rotary Hammer (XRH01Z), (2) 18V LXT® Lithium-Ion 5.0Ah Battery (BL1850B), 18V LXT® Lithium-Ion Rapid Optimum Charger (DC18RC), Dust Extractor Attachment with HEPA Filter (DX01), Side Handle (158057-6), Depth Gauge (324219-0), Tool Bag
- XRH01ZX Includes:** Tool only, battery & charger not included. Dust Extractor Attachment with HEPA Filter (DX01), 20" Contractor Tool Bag (831303-9)

Max. Capacity (concrete drilling)	1"
Optimum Range (concrete drilling)	3/16" - 1/2"
Impact Energy (ft.lbs.)	1.7
Impact Energy (Joules)	2.4 J
Blows Per Minute (variable speed)	0 - 4,700 BPM
No Load Speed (variable speed)	0 - 950 RPM
HEPA filter	Yes
Container Hole Count Capacity	25 holes of dimension 5/8"x2"
Filter Life (Approx. container fillings)	200
Vibration Control	No
Vibration (m/s ²)	13.5
Battery	18V LXT® Lithium-Ion
Overall Length	14-5/8"
Net Weight (with battery)	10.2 lbs.
Shipping Weight	19.6 lbs.
Bit Type	Accepts SDS-PLUS



AVT **HEPA filter**

HR2651

1" AVT® Rotary Hammer w/ HEPA Dust Extractor

- Powerful 7 AMP motor delivers 1.6 ft.lbs./2.2 J. of impact energy to handle the most demanding applications
- Anti-Vibration Technology (AVT®) is an internal counterbalance system that greatly reduces vibration
- The built-on dust extractor captures concrete dust during drilling and is activated by the tool for operator convenience
- Efficient HEPA filtration system captures 99.97% of particulates .3 microns and larger
- Transparent dust container provides needed visibility in determining when the dust box needs to be emptied
- Torque limiting clutch engineered to prevent gear damage by automatically disengaging gears if the bit binds

HR2651 Includes: Dust Extractor Attachment with HEPA Filter (135905-6), (6) Sealing Cap (424474-5), Side Handle, Depth Rod, Tool Case

AMPS	7
Max. Capacity (concrete drilling)	1"
Optimum Range (concrete drilling)	1/4" - 5/8"
Max. Hole Depth	7-7/16"
Max. Capacity (concrete drilling w/ core bit)	3-1/8"
Impact Energy (ft.lbs.)	1.6
Blows Per Minute (variable speed)	0 - 4,600 BPM
No Load Speed (variable speed)	0 - 1,200 RPM
HEPA filter	Yes
Container Hole Count Capacity	36 holes of dimension 3/8"x2-3/8"
Filter Life (Approx. container fillings)	200
Vibration Control	Yes
Vibration (m/s ²)	11.5
Sound Rating (decibels)	90 dB(A)



LXT BRUSHLESS

XRH01T **XRH01Z**

18V LXT® Brushless 1" Rotary Hammer Kit

- Powerful BL™ Brushless motor delivers 0-950 RPM, 0-4,700 BPM and 1.7 ft.lbs. of impact energy to handle the most demanding applications
 - The BL™ Brushless Motor eliminates carbon brushes, enabling the BL™ Motor to run cooler and more efficiently for longer life
 - Compatible with built-on HEPA Dust Extraction Vacuum Attachment part no. DX01 (sold separately) for improved dust extraction mobility
 - 3-Mode operation for "Rotation Only", "Hammering with Rotation" or "Hammering Only"
- XRH01T Includes:** 18V LXT® Brushless 1" Rotary Hammer (XRH01Z), (2) 18V LXT® Lithium-Ion 5.0Ah Battery (BL1850B), 18V LXT® Lithium-Ion Rapid Optimum Charger (DC18RC), Side Handle (158057-6), Depth Gauge (324219-0), 20" Contractor Tool Bag (831303-9)
- XRH01Z Includes:** Tool only, battery & charger not included. Side Handle (158057-6), Depth Gauge (324219-0)

Max. Capacity (concrete drilling)	1"
Optimum Range (concrete drilling)	3/16" - 1/2"
Impact Energy (ft.lbs.)	1.7
Impact Energy (Joules)	2.4 J
Blows Per Minute (variable speed)	0 - 4,700 BPM
No Load Speed (variable speed)	0 - 950 RPM
Vibration Control	No
Vibration (m/s ²)	13.5
Battery	18V LXT® Lithium-Ion
Overall Length	12-7/8"
Net Weight (with battery)	7.2 lbs.
Shipping Weight	19 lbs.
Bit Type	Accepts SDS-PLUS



AVT

HR2631F

1" AVT® Rotary Hammer

- Powerful 7 AMP motor delivers 2.1 ft.lbs. of impact energy to handle the most demanding applications
- Anti-Vibration Technology (AVT®) is an internal counterbalance system that greatly reduces vibration
- Torque limiting clutch engineered to prevent gear damage by automatically disengaging gears if the bit binds
- L.E.D. light illuminates drilling surface for more productivity in low light applications
- Designed to reduce dust exposure in drilling applications with dust extraction accessory (part no.195173-3)

HR2631F Includes: Side Handle (451749-9), Depth Gauge (331886-4), Tool Case (824695-3)

AMPS	7
Max. Capacity (concrete drilling)	1"
Optimum Range (concrete drilling)	3/16" - 1/2"
Max. Capacity (concrete drilling w/ core bit)	2-11/16"
Impact Energy (ft.lbs.)	2.1
Blows Per Minute (variable speed)	0 - 4,600 BPM
No Load Speed (variable speed)	0 - 1,200 RPM
Vibration Control	Yes
Vibration (m/s ²)	11.5
Overall Length	15-1/8"
Cord Length (ft)	13.1'
Net Weight	6.6 lbs.
Shipping Weight	13.2 lbs.
Bit Type	Accepts SDS-PLUS



LXT

XRH04T **XRH04Z**

18V LXT® 7/8" Rotary Hammer Kit

- Makita-built variable speed motor delivers 0-1,200 RPM and 0-4,000 BPM
 - 3-mode operation for "Rotation Only", "Hammering with Rotation" or "Hammering Only" for multiple applications
 - Torque limiting clutch reduces gear damage by automatically disengaging gears if bit binds
 - Faster drilling with synchronized RPM and BPM
 - Job site tested shock absorbent handle protects the battery housing for extra durability
 - Large 2-finger variable speed trigger for added convenience
- XRH04T Includes:** 18V LXT® 7/8" Rotary Hammer (XRH04Z), (2) 18V LXT® Lithium-Ion 5.0Ah Battery (BL1850B), 18V LXT® Lithium-Ion Rapid Optimum Charger (DC18RC), Side Handle (158057-6), Depth Gauge (324219-0), Tool Bag (821016-X)
- XRH04Z Includes:** Tool only, battery & charger not included. Side Handle (158057-6), Depth Gauge (324219-0)

Max. Capacity (concrete drilling)	7/8"
Optimum Range (concrete drilling)	5/32" - 1/2"
Impact Energy (ft.lbs.)	1.4
Impact Energy (Joules)	1.9 J
Blows Per Minute (variable speed)	0 - 4,000 BPM
No Load Speed (variable speed)	0 - 1,200 RPM
Vibration Control	No
Vibration (m/s ²)	12.5
Battery	18V LXT® Lithium-Ion
Overall Length	16-3/8"
Net Weight (with battery)	7.7 lbs.
Shipping Weight	16.2 lbs.
Bit Type	Accepts SDS-PLUS



HR2475

1" Rotary Hammer

- Powerful 7.0 AMP motor delivers 2 ft.lbs. of impact energy
- 3-mode operation for "Rotation Only", "Hammering with Rotation" or "Hammering Only"
- Variable speed trigger enables user to match the speed to the application for greater versatility
- Ergonomic "D-shaped" handle with rubberized soft grip for increased comfort
- One-touch sliding chuck for quick bit changes

HR2475 Includes: Side Handle (158057-6), Depth Gauge (324219-0), Tool Case (824695-3)

AMPS	7
Max. Capacity (concrete drilling)	1"
Optimum Range (concrete drilling)	3/16" - 1/2"
Max. Capacity (concrete drilling w/ core bit)	3-1/8"
Impact Energy (ft.lbs.)	2
Blows Per Minute (variable speed)	0 - 4,500 BPM
No Load Speed (variable speed)	0 - 1,100 RPM
Vibration Control	No
Vibration (m/s ²)	15.5
Overall Length	16-7/8"
Cord Length (ft)	13.1'
Net Weight	6.6 lbs.
Shipping Weight	11.9 lbs.
Bit Type	Accepts SDS-PLUS



LXT

XRH03T **XRH03Z**

18V LXT® 7/8" Rotary Hammer Kit

- Makita-built variable speed motor delivers 0-1,200 RPM and 0-4,000 BPM
 - 3-mode operation for "rotation only", "hammering with rotation" or "hammering only" for multiple applications
 - Large 2-finger variable speed trigger for added convenience
 - Faster drilling with synchronized RPM and BPM
 - One-touch sliding chuck for quick bit changes
 - Torque limiting clutch reduces gear damage by automatically disengaging gears if bit binds
- XRH03T Includes:** 18V LXT® 7/8" Rotary Hammer (XRH03Z), (2) 18V LXT® Lithium-Ion 5.0Ah Battery (BL1850B), 18V LXT® Lithium-Ion Rapid Optimum Charger (DC18RC), Side Handle (158057-6), Depth Gauge (324219-0), Tool Bag
- XRH03Z Includes:** Tool only, battery & charger not included. Side Handle (158057-6), Depth Gauge (324219-0)

Max. Capacity (concrete drilling)	7/8"
Optimum Range (concrete drilling)	5/32" - 1/2"
Impact Energy (ft.lbs.)	1.4
Impact Energy (Joules)	1.9 J
Blows Per Minute (variable speed)	0 - 4,000 BPM
No Load Speed (variable speed)	0 - 1,200 RPM
Vibration Control	No
Vibration (m/s ²)	14.5
Battery	18V LXT® Lithium-Ion
Overall Length	14-1/8"
Net Weight (with battery)	7.7 lbs.
Shipping Weight	16 lbs.
Bit Type	Accepts SDS-PLUS



LXT SUB-COMPACT BRUSHLESS

XRH06RB

XRH06ZB

18V LXT® Sub-Compact Brushless 11/16" Rotary Hammer Kit

- Brushless motor delivers 0-680 RPM, 0-4,800 BPM and .88 ft.lbs./1.2 Joules of impact energy for faster drilling
- Compact and Ergonomic design at only 10-3/4"
- Weighs only 4.6 lbs. with battery for reduced operator fatigue
- Vibration absorbing handle moves independently of the motor and hammer mechanism for increased operator comfort
- Efficient BL™ Brushless motor is electronically controlled to optimize battery energy use for up to 50% longer run time per charge

XRH06RB Includes: 18V LXT® Sub-Compact Brushless 11/16" Rotary Hammer (XRH06ZB), (2) 18V LXT® Lithium-Ion Compact 2.0Ah Battery (BL1820B), 18V LXT® Lithium-Ion Rapid Optimum Charger (DC18RC), Tool Bag, Side Handle

XRH06ZB Includes: Tool only, battery & charger not included
Depth Gauge (415486-9), Side Handle (144216-4)

Max. Capacity (concrete drilling)	11/16"
Optimum Range (concrete drilling)	5/32" - 3/8"
Impact Energy (ft.lbs.)	.88
Impact Energy (Joules)	1.2 J
Blows Per Minute (variable speed)	0 - 4,800 BPM
No Load Speed (variable speed)	0 - 680 RPM
Vibration Control	Yes
Vibration (m/s ²)	9
Battery	18V LXT® Compact Lithium-Ion
Overall Length	10-3/4"
Net Weight (with battery)	4.6 lbs.
Shipping Weight	9.702 lbs.
Bit Type	Accepts SDS-PLUS



OSHA COMPLIANT
1926.1193

LXT BRUSHLESS

XRH12TW

XRH12ZW

18V LXT® Brushless 11/16" AVT® Rotary Hammer Kit w/ Dust Extractor, AWS™ Capable

- OSHA Table 1 compliant on-board dust extractor includes a filter cleaning mechanism designed to help maintain optimum suction efficiency
- Efficient HEPA filtration system captures 99.97% of particulates .3 microns and larger
- The BL™ Brushless Motor eliminates carbon brushes, enabling the BL™ Motor to run cooler and more efficiently for longer life
- AWS™ utilizes Bluetooth® technology for wireless power-on/off communication between tool and dust extractor (transmitter sold separately)

XRH12TW Includes: 18V LXT® Brushless 11/16" AVT® Rotary Hammer, AWS™ Capable (XRH12Z), (2) 18V LXT® Lithium-Ion 5.0Ah Battery (BL1850B), 18V LXT® Lithium-Ion Rapid Optimum Charger (DC18RC), Dust Extractor Attachment with HEPA Filter Cleaning Mechanism (DX05), Sealing Cap (424474-5), Depth Gauge, Side Handle, Tool Bag

XRH12ZW Includes: Tool only, battery & charger not included
Dust Extractor Attachment with HEPA Filter Cleaning Mechanism (DX05), Sealing Cap (424474-5), Tool Bag, Side Handle, Depth Gauge

Max. Capacity (concrete drilling)	11/16"
Optimum Range (concrete drilling)	5/32" - 3/8"
Impact Energy (Joules)	1.7 J
Impact Energy (ft.lbs.)	1.2
Blows Per Minute (variable speed)	0 - 5,000 BPM
No Load Speed (variable speed)	0 - 1,350 RPM
Vibration (m/s ²)	11
HEPA filter	Yes
Container Hole Count Capacity	36 holes of dimension 3/8"x2-3/8"
Filter Life (Approx. container fillings)	200
Battery	18V LXT® Lithium-Ion
Overall Length	11-7/8"
Net Weight (with battery)	7.5 lbs.
Bit Type	Accepts SDS-PLUS



HR1840

11/16" Rotary Hammer

- Powerful 4.5 AMP motor delivers 1.03 ft.lbs of impact energy to handle the most demanding applications
- Torque limiting clutch engineered to prevent gear damage by automatically disengaging gears if the bit binds
- Variable speed trigger enables user to match the speed to the application for greater versatility
- 2-mode operation for "Rotation Only" or "Hammering with Rotation"
- For dust management use available Dust Extraction Cup: Includes Side Handle Spacer, Side Handle Base and Bolt

HR1840 Includes: Depth Gauge (415486-9), Tool Case (821706-5), Side Handle

AMPS	4.5
Max. Capacity (concrete drilling)	11/16"
Optimum Range (concrete drilling)	5/32" - 3/8"
Max. Capacity (concrete drilling w/ core bit)	1-3/8"
Impact Energy (ft.lbs.)	1.03
Blows Per Minute (variable speed)	0 - 4,800 BPM
No Load Speed (variable speed)	0 - 2,100 RPM
Vibration Control	No
Vibration (m/s ²)	10
Overall Length	11-1/4"
Cord Length (ft)	13.1'
Net Weight	4.3 lbs.
Shipping Weight	10.8 lbs.
Bit Type	Accepts SDS-PLUS



HP2070F

3/4" Hammer Drill

- Powerful 8.2 AMP motor for heavy duty use
- 2-mode operation for "hammering with rotation" or "rotation only"
- Large trigger switch and 360° swivel side handle for maneuverability
- Built-in clutch reduces gear damage by disengaging gears if bit binds
- Ball bearing construction for longer tool life
- L.E.D. light illuminates the work area

HP2070F Includes: Side Handle (152521-9), Chuck Key (763430-3), Depth Gauge (324219-0), Tool Case (824650-5)

Max. Capacity (concrete drilling)	3/4"
Capacities (steel: low, high)	5/8", 5/16"
Capacities (wood: low, high)	1-9/16", 1"
No Load Speed (var. 2 spd)	0 - 1,200 / 0 - 2,900 RPM
Blows Per Minute (2 speed)	0 - 24,000 / 0 - 58,000 BPM
AMPS	8.2
Chuck Size	1/2"
Overall Length	14-1/4"
Net Weight	5.3 lbs.
Shipping Weight	9.55 lbs.



HP2050 shown

HP2050 / HP2050F*

3/4" Hammer Drill

- Powerful 6.6 AMP motor for the most demanding jobs
- 2-mode operation "Rotation Only" and "Hammering with Rotation" for multiple applications
- 2-speed, variable speed (0-1,200 & 0-2,900 RPM) with variable speed control dial
- Lock-on button for continuous use
- Ergonomic rubberized "Pistol-grip" for increased comfort on the job
- Built-in clutch reduces gear damage by disengaging gears if bit binds

HP2050 Includes: Side Handle (153503-4), Depth Gauge (324219-0), Chuck Key (763430-3), Tool Case (824650-5)

Max. Capacity (concrete drilling)	3/4"
Capacities (steel: low, high)	1/2", 5/16"
Capacities (wood: low, high)	1-9/16", 1"
No Load Speed (var. 2 spd)	0 - 1,200 / 0 - 2,900 RPM
Blows Per Minute (2 speed)	0 - 24,000 / 0 - 58,000 BPM
AMPS	6.6
Chuck Size	1/2"
Overall Length	14-1/4"
Net Weight	5.6 lbs.
Shipping Weight:	HP2050 (9 lbs.), HP2050F (8.8 lbs.)



HP2010N

HP2010N

3/4" Hammer Drill

- Powerful 6 AMP motor for the most demanding applications
- 2-speed (0-900 & 0-2,300 RPM) with speed control switch
- 2-mode operation for "Rotation Only" or "Hammering with Rotation" for multiple applications
- Variable speed switch for easy starting of holes
- Depth gauge for "drop-in" type anchors
- Adjustable side handle for greater control

HP2010N Includes: 1/2" Drill Chuck (763047-2), Chuck Key (798341-3), Side Handle (122428-3), Depth Gauge (321059-7), Tool Case (824608-4)

Capacities (concrete: low, high)	3/4", 1/2"
Capacities (steel: low, high)	1/2", 1/4"
Capacities (wood: low, high)	1-1/2", 3/4"
No Load Speed (var. 2 spd)	0 - 900 / 0 - 2,300 RPM
Blows Per Minute (2 speed)	0 - 18,000 / 0 - 46,000 BPM
AMPS	6
Chuck Size	1/2"
Overall Length	13-3/4"
Net Weight	6.4 lbs.
Shipping Weight	11.6 lbs.



HP1641K

HP1641K

5/8" Hammer Drill, with Keyless Chuck

- 2-mode operation "rotation only" or "hammering with rotation" for multiple applications
- Powerful 6.0 AMP motor for the most demanding applications
- Lightweight (4.3 lbs.) with large drilling capacity
- Soft grip handle provides increased comfort on the job
- All ball bearing construction for longer tool life
- Recessed lock-on button for continuous use

HP1641K Includes: Keyless Drill Chuck (766017-0), Side Handle (153503-4), Depth Gauge (324219-0), Tool Case (824877-7)

Max. Capacity (concrete drilling)	5/8"
Capacity (steel)	1/2"
Capacity (wood)	1-3/16"
No Load Speed (variable speed)	0 - 2,800 RPM
Blows Per Minute (variable speed)	0 - 44,800 BPM
AMPS	6
Chuck Size	1/2"
Overall Length	11-7/8"
Net Weight	4.3 lbs.
Shipping Weight	7.5 lbs.



HP1640

5/8" Hammer Drill

- Powerful 6.0 AMP motor for the most demanding applications
- 2-mode operation "rotation only" or "hammering with rotation" for multiple applications
- Soft grip handle provides increased comfort on the job
- All ball bearing construction for longer tool life
- Recessed lock-on button for continuous use

HP1640 Includes: Drill Chuck (192541-1), Chuck Key (763440-0), Side Handle (153503-4), Depth Gauge (324219-0)

Max. Capacity (concrete drilling)	5/8"
Capacity (steel)	1/2"
Capacity (wood)	1-3/16"
No Load Speed (variable speed)	0 - 2,800 RPM
Blows Per Minute (variable speed)	0 - 44,800 BPM
AMPS	6
Chuck Size	1/2"
Overall Length	11-7/8"
Net Weight	4.4 lbs.
Shipping Weight	6 lbs.

*HP2050F includes L.E.D. light



INCREASED PERFORMANCE



INNOVATION

Pressure compensated carburetor with vented choke plate reduces flooding



CONVENIENCE

Integrated wheel kit retracts when not in use



PERFORMANCE

Fuel primer bulb for easier cold starts



EK7651H

14" 75.6 cc MM4® 4-Stroke Engine Power Cutter

- Automatic engine decompression valve is engineered into the cam gear to reduce pull-start force by 40%
- Pressure compensated carburetor with vented choke plate allows for optimum fuel delivery and reduces the occurrence of flooding during cold starts
- Integrated all aluminum wheels reduce fatigue during long straight cuts and retract when not in use
- Eliminates the need for separate mixed oil/fuel can
- Lower noise at 92.7dB(A) and smoother idle for continuous operation
- Five-stage, foam-paper-nylon filtration system with advance direction air flow provides cleaner air for better engine durability
- Lower fuel consumption at .45 gallons per hour
- Reduced exhaust and intake carbon build-up for long cylinder life
- Three ring piston for improved commercial engine durability
- Clear primer bulb facilitates fuel delivery to the carburetor for easier cold starts

EK7651H Includes: Universal Wrench (941-719-132), Adapter Ring (20mm to 1") (394-228-121), Maintenance Kit (195488-8), Water Attachment (195533-9), Coupling (123120-4), Filter Set (5 + 1) (199599-9), Dust Bag (166106-5)

Engine Displacement (cu.in./cc)	4.61 cu.in. (75.6 cc)
Engine (max power)	4.1 HP/3 kW
No Load Speed/Max. Spindle Speed	9,100 / 4,300 RPM
Fuel Type	Unleaded gas
Fuel Tank Capacity	37 oz.
Arbor w/ Adaptor	20mm/1" adaptor
Max. Cutting Depth	4-13/16"
Dry Weight	28.3 lbs.
Shipping Weight	35.2 lbs.

Engine seizure due to improper fuel and oil mixing is one of the most common failures of 2-stroke power equipment. Makita has a solution with efficient MM4® 4-stroke engine power equipment. Makita MM4® 4-stroke advantage means no more fuel mixing for simplified operation and no need for a separate mixed oil-fuel can.

In addition, Makita MM4® 4-stroke engines are engineered for lower noise, improved fuel economy, reduced exhaust, and faster, easier starts for increased efficiency. MM4® 4-stroke power equipment includes a concrete power cutter as well as blowers, hedge trimmers, string trimmers, pole pruners, and more.

POWER CUTTER ACCESSORIES

DIAMOND BLADES

Segmented Rim

- Segment slots help deliver a faster, cooler cut in multiple applications



Blade Diameter	Material	Part #
12"	Cured Concrete, Block, Brick	A-94720
	Concrete, Asphalt	T-01264
14"	Cured Concrete, Fire Brick	A-94627
	Asphalt, Sandstone, Green Concrete	A-94655
	Concrete, Asphalt	T-01270
	Cured Concrete, Block, Brick	A-94736
	Cured Concrete, Block, Brick	A-94932 ¹
	Cured Concrete, Fire Brick	A-94627
16"	Concrete, Asphalt, Granite	T-02537
	Ferrous Metal	A-96229
	Asphalt, Sandstone, Green Concrete	A-94661
	Cured Concrete, Block, Brick	A-94742
	Concrete, Asphalt	T-01286

¹ Contractor Pack (3-Pack)

DOLLY & ATTACHMENTS / ENGINE OIL

2.6 Gallon Pressurized Water Tank



Pre-Filter



Air Filter



Inner Filter



5+1 Filter Set



2-Cycle Synthetic Engine Oil

All 2-Cycle Models



Description	Part #	
Water Tank	988-394-610	
Model	Part #	
DPC6410, DPC7310, DPC7311, DPC7321, EK7301, DPC8112	326-173-081	
DPC7331, EK7301, DPC8132, EK8100	395-173-081	
DPC7310, DPC7311	394-173-030	
EK7651H	195945-6	
DPC6410, DPC7310, DPC7311, DPC7321, DPC8112	394-173-010	
DPC7331, DPC8132, EK7301, EK8100	395-173-011	
EK7651H	442165-6	
EPC6410, DPC7310, DPC7311, DPC7321, DPC8112	394-173-020	
DPC7331, DPC8132, EK7301, EK8100	395-173-020	
EK7651H	424399-3	
DPC7331, EK7301, EK8100	957-173-110	
Size	Qty./Pkg.	Part #
2.6 oz.	1	T-00745
	48	T-00745-48
6.4 oz.	1	T-00739
	48	T-00739-48

Dolly & Attachments

- Comes completely assembled
- Depth-wheel weighted for greater stability
- "Tool-less" attachment - saw to dolly
- Quick adjusting ratchet system



Description	Model	Part #
Dolly & Gravity Feed Tank		DT20102
Angled Gas Filler	EK7301, EK8100	010-114-040
Water Attachment Kit		394-365-630
Dolly & Gravity Feed Tank	EK7651H	DT4000
Water Attachment Kit		195533-9

2 Use with Water Attachment Kit #394-365-630



Description	Part #
Torx Wrench	940-827-000



ADVANCED™
LUBRICATION SYSTEM

EK8100

16" 81 cc Power Cutter

- Improved deco-valve and metering spring for precise fuel regulation
- Start capacitor with start support function stores electrical energy resulting in significantly less pull start force
- On-Off-choke operation on a single lever for operator convenience
- Five stage filtration system with advanced directional air flow, for better saw performance
- SLR Muffler recycles un-burned fuel vapor for reduced scavenging-losses and up to 15% improved fuel consumption
- Microchip controlled carburetor designed to compensate engine timing according to work load

EK8100 Includes: 16" Abrasive Cut-Off Wheel, Masonry (966-161-020), Universal Wrench (941-719-140), Torx Wrench (940-827-000), Carburetor Screwdriver (944-340-001), Adapter Ring (20mm to 1") (394-228-121), Power Cutter Water Attachment Kit (394-365-630)

Engine Displacement (cu.in./cc)	4.9 cu.in. (81 cc)
Engine (max power)	5.6 HP/4.2 kW
No Load Speed/Max. Spindle Speed	9,350 / 3,820 RPM
Fuel Mixture	50:1
Fuel Tank Capacity	37 oz.
Arbor w/ Adaptor	20mm/1" adaptor
Max. Cutting Depth	5-3/4"
Dry Weight	23.3 lbs.
Shipping Weight	31.7 lbs.



ADVANCED™
LUBRICATION SYSTEM

EK7301

14" 73 cc Power Cutter

- Improved decompression valve and metering spring for precise fuel regulation
- Start capacitor with start support function resulting in significantly less pull start force
- On-Off-Choke operation on a single lever for operator convenience
- Five stage filtration system with advanced directional air flow, for better saw performance
- SLR Muffler recycles un-burned fuel vapor for reduced scavenging-losses and up to 15% improved fuel consumption
- Improved ignition system with large flywheel and rare earth magnets create more efficient power

EK7301 Includes: Universal Wrench (941-719-141), Torx Wrench (782025-3), Carburetor Screwdriver (944-340-001), Adapter Ring (20mm to 1") (394-228-121), Water Attachment (394-365-631)

Engine Displacement (cu.in./cc)	4.5 cu.in. (73 cc)
Engine (max power)	5.1 HP/3.8 kW
No Load Speed/Max. Spindle Speed	9,350 / 4,300 RPM
Fuel Mixture	50:1
Fuel Tank Capacity	37 oz.
Arbor w/ Adaptor	20mm/1" adaptor
Max. Cutting Depth	4-13/16"
Dry Weight	22 lbs.
Shipping Weight	29.3 lbs.



EK6101

14" 61 cc Power Cutter

- Cyclonic air Intake delivers more air, more efficiently and increases air filter life by discarding 90% of larger debris
- Start capacitor with start support function resulting in significantly less pull start force
- Smaller hub and drive wheel assembly increases maximum cutting depth to 5-1/8"
- Stratified Air Scavenging (SAS) recovers 75% of unburned fuel and reduces fuel consumption by 20%
- Sliding front engine mounts help absorb vibration by detaching when cutting pressure is applied

EK6101 Includes: Universal Wrench (941-719-140), Torx Wrench (940-827-000), Carburetor Screwdriver (944-340-001), Adapter Ring (20mm to 1") (315-228-121)

Engine Displacement (cu.in./cc)	3.7 cu.in. (61 cc)
Engine (max power)	4.4 HP/3.2 kW
No Load Speed/Max. Spindle Speed	9,850 / 4,400 RPM
Fuel Mixture	50:1
Fuel Tank Capacity	23.6 oz.
Arbor w/ Adaptor	20mm/1" adaptor
Max. Cutting Depth	5-1/8"
Dry Weight	19.6 lbs.
Shipping Weight	23.8 lbs.



SJS™

4114

14" SJS™ Angle Cutter

- SJS™ technology is a mechanical clutch system that helps prevent motor and gear damage
- Built-in vacuum attachment port and rubber shield reduces dust and debris
- Rubber shield helps keep debris away from operator and from entering the motor
- Powerful 15.0 AMP motor delivers 3,800 RPM for the most demanding applications
- AC/DC switch for use with alternative power source

4114 Includes: Socket Wrench (782210-8), Tool Cuff Elbow Joint Adapter, 32mm (192613-2)

Blade Diameter	14"
AMPS	15
No Load Speed	3,800 RPM
Max. Cutting Depth (14" diamond blade)	5"
Max. Cutting Depth (14" cut-off wheel)	5"
Arbor	1"
Overall Length	26-1/2"
Net Weight	23.8 lbs.
Shipping Weight	30.4 lbs.



SJS™II

GA5040X1

5" SJS™II Angle Grinder with Cutting/Tuck Point Guard

- Powerful 10.0 AMP motor delivers more output and 11,000 RPM
- SJS™II provides a drive mechanism that is engineered to reduce vibration for increased operator comfort during extended use
- Zig-zag epoxy is applied to the armature coil for protection from debris and longer tool life
- Includes 5" dust extraction tuck point guard for clean and accurate tuck pointing and cutting
- Plunge feature allows for maximum material removal and up to 1" cutting depth when used with a 5" blade
- Guard offers a durable, high quality metal construction

GA5040X1 Includes: 5" Dust Extraction Tuck Point Guard (196845-3), Inner Flange (224399-1), Lock Nut Wrench (782412-6), 5" Dual Sandwich Diamond Tuck Point Blade (A-96017), 5" Tool-less Wheel Guard (123145-8), Side Handle (153489-2), Lock Nut (224568-4)

Wheel Diameter	5"
AMPS	10
No Load Speed	11,000 RPM
Max. Cutting Depth	1"
Spindle Thread	5/8" - 11 UNC
Lock-On Switch	Yes
Lock-Off Switch	No
Switch Type	Body grip/slide
Overall Length	11-7/8"
Net Weight	5.4 lbs.
Shipping Weight	12 lbs.

LESS VIBRATION

POWER

Powerful 12.0 AMP motor delivers more output and variable (2,800 - 11,000) RPM

DURABILITY

SJS™II technology is a leaf spring and cam gear drive mechanism engineered to reduce vibration

SJS™II

GA5042CX1

5" SJS™II High-Power Grinder with Cutting/Tuck Point Guard

- Powerful 12.0 AMP motor delivers more output and variable (2,800 - 11,000) RPM
- SJS™II provides a leaf spring and cam gear drive mechanism that is engineered to reduce vibration for increased operator comfort during extended use
- Includes a 5" dust extraction tuck point guard for clean and accurate tuck pointing and cutting
- Electronic Controller is a three-part electronic feature designed to provide the required power in high torque applications and increase tool life
- Complete zig-zag epoxy is applied to both sides of the armature coil and a powder coating to the field for protection from debris and longer tool life
- Variable speed control dial enables user to match the speed to the application

GA5042CX1 Includes: 5" Dust Extraction Tuck Point Guard (196845-3), Inner Flange (224399-1), Lock Nut Wrench (782412-6), 5" Dual Sandwich Diamond Tuck Point Blade (A-96017), 5" Tool-less Wheel Guard (123145-8), (162258-0), Lock Nut (224568-4)

Wheel Diameter	5"
AMPS	12
No Load Speed (variable speed)	2,800 - 11,000 RPM
Max. Cutting Depth	1"
Spindle Thread	5/8" - 11 UNC
Lock-On Switch	Yes
Lock-Off Switch	No
Switch Type	Body grip/slide
Overall Length	11-7/8"
Net Weight	5.4 lbs.
Shipping Weight	13 lbs.

TUCK POINT / DIAMOND WHEEL



196846-1 / 196845-3 5" Dust Extraction Tuck Point Guard

- Easily adjustable depth setting for quick changes



A-95906 4" Dual Sandwich Diamond Tuck Point Blade

- Dual sandwich design allows for faster and more efficient cuts



A-95912 4-1/2" Dual Sandwich Diamond Tuck Point Blade

- Dual sandwich design allows for faster and more efficient cuts



A-96017 5" Dual Sandwich Diamond Tuck Point Blade

- Dual sandwich design allows for faster and more efficient cuts

CONCRETE PLANER ACCYS.

Diamond Cup Wheels

- Low-Vibration design engineered to keep the wheel planted firmly on the surface for more efficient material removal

Size	Description	Model	Part #
4-3/8"	Continuous rim	PC1100	792289-1
	Segmented rim		724907-1A
4-1/2"	Double Row	PC5010C	A-96198
	Turbo Rim		A-96403
5"	Segmented rim	PC5000C, PC5001C, PC5010C	A-95009
	Continuous rim		A-94998
	Turbo rim		A-98871

DIAMOND BLADES

Segmented Rim

- Segment slots help deliver a faster cooler cut in multiple applications

Blade Diameter	Material	Part #
4"	Cured Concrete, Block, Brick	A-94677
5"	Cured Concrete, Block, Brick	A-94699

Turbo Rim

- Constant contact with material delivers a smoother finish than segmented blades

Blade Diameter	Material	Part #
4"	Cured Concrete, Block, Brick	A-94546
	Granite, Ceramic, Fire Brick	A-94580
5"	Cured Concrete, Block, Brick	A-94568
	Granite, Ceramic, Fire Brick	A-94605

SEE MORE // pg.138-139



4100KB

5" Dry Masonry Saw, with Dust Extraction

- Powerful 13 AMP motor delivers 12,200 RPM for the most demanding applications
- Transparent upper guard dust cover for increased visibility
- High depth of cut capacity up to 1-9/16" at 90°
- Saw attaches to optional guide rail with guide rail adapter (#198673-2) to provide straight and accurate cutting
- 1-3/8" (38mm) dust extraction port swivels 360° for convenient operation
- Large rubberized depth gauge lever for easy adjustment

4100KB Includes: Hex Wrench (783203-8), Spanner Wrench (781041-2), Dust Bag (126738-0)

AMPS	13
Watts Out	1,800
No Load Speed	12,200 RPM
Blade Diameter	5"
Max. Cutting Depth	1-9/16"
Arbor	13/16"
Overall Length	9-1/8"
Net Weight	6.6 lbs.
Shipping Weight	10.6 lbs.



4101RH

5" Masonry Saw

- Powerful 7.9 AMP motor for the most demanding jobs
- Special cover engineered to prevent water from entering into motor housing
- Includes 15 ft. of tubing, water pressure regulator and water valve
- Ground fault circuit interrupter (GFCI) plug
- Cuts up to 1-5/8" at 90° and 1" at 45°
- Lock-on button for continuous operation

4101RH Includes: 5" Diamond Blade, Continuous Rim, Wet Cutting (A-90934), Hex Wrench (783203-8), Spanner Wrench (781011-1)

AMPS	7.9
Watts Out	1,050
No Load Speed	13,800 RPM
Blade Diameter	5"
Max. Cutting Capacity (at 90°)	1-5/8"
Max. Cutting Capacity (at 45°)	1"
Arbor	3/4"
Overall Length	9-1/4"
Net Weight	6.5 lbs.
Shipping Weight	9.3 lbs.



4100NH

4-3/8" Masonry Saw

- Powerful 12 AMP motor
- Cuts up to 1-3/8"
- Compact and lightweight at only 6.5 lbs.
- High power to weight ratio; 14,500 RPM
- Lock-off button helps prevent accidental starts
- Flat rear side of motor housing allows for easy blade changes

4100NH Includes: Socket Wrench (782209-3), Spanner Wrench (781011-1), 4" Diamond Blade, Turbo, General Purpose (A-94546)

AMPS	12
Watts Out	1,500
No Load Speed	14,500 RPM
Blade Diameter	4-3/8"
Max. Cutting Capacity (at 90°)	1-3/8"
Arbor	3/4"
Overall Length	8-5/8"
Net Weight	6.5 lbs.
Shipping Weight	9.46 lbs.



SJS II

PC5010C

5" SJS™II Concrete Planer with Dust Extraction Shroud

- Integrated dust extraction shroud is designed to capture dust during concrete surfacing applications
- Powerful 12.0 AMP motor delivers more output and (4,000 - 9,000) RPM
- SJS™II provides a drive mechanism that is engineered to reduce vibration for increased comfort during extended use
- Variable speed control dial allows manual RPM adjustment (4,000-9,000) to match the speed to the application
- Constant Speed Control automatically applies additional power to the motor to maintain speed under load
- Soft Start suppresses start-up reaction for smooth start-ups and longer gear life

PC5010C Includes: Lock Nut Wrench (782425-7), 4-1/2" - 5" Front Edge Cover (451765-1), Replacement Brush Set (196880-1), Tool Storage Case

Wheel Diameter	5"
No Load Speed (variable speed)	4,000 - 9,000 RPM
AMPS	12
Overall Length	13-3/4"
Constant speed control	Yes
Spindle Thread	5/8" - 11 UNC
Soft start	Yes
Electric current limiter	Yes
Switch Type	Body grip/slide
Lock-On Switch	Yes
Lock-Off Switch	No
Net Weight	5.5 lbs.
Shipping Weight	19.4 lbs.



PC5000C

5" Concrete Planer

- Powerful 10 AMP motor delivers more output and 10,500 RPM
- Constant Speed Control automatically applies additional power to the motor
- Soft start suppresses start-up reaction for more precision and longer tool life
- Electronic current limiter helps protect the motor from overload
- Anti-restart prevents accidental start up after power loss
- Large two-finger trigger switch with lock-on for continuous operation

PC5000C Includes: 5" Diamond Cup Wheel, Segmented Rim (A-95009), Lock Nut Wrench (782425-7), Hex Wrench (783203-8), Dust Bag (122853-8), Brush Set (194921-7), Steel Tool Case

Wheel Diameter	5"
No Load Speed	10,000 RPM
AMPS	10
Overall Length	17-1/8"
Net Weight	8.9 lbs.
Shipping Weight	8.9 lbs.



PC5001C

5" Concrete Planer

- Powerful 10.0 AMP motor delivers more output and 10,500 RPM
- Constant Speed Control automatically applies additional power to the motor
- Soft start suppresses start-up reaction for more control and longer tool life
- Electronic current limiter helps protect the motor from overload
- Anti-restart prevents accidental start up after power loss

PC5001C Includes: 5" Diamond Cup Wheel, Continuous Rim (A-94998), Hex Wrench (783203-8), Lock Nut Wrench (782425-7), Dust Bag (122853-8), Brush Set (194921-7), Steel Tool Case

Wheel Diameter	5"
No Load Speed	10,000 RPM
AMPS	10
Overall Length	18-13/16"
Net Weight	11.2 lbs.
Shipping Weight	26.5 lbs.



VC4710 // 12 GALLON XTRACT VAC® WET/DRY DUST EXTRACTOR/VACUUM (see pg. 62)

NEW XCV08PT, XCV05PT, DRC200PT // 18V X2 LXT® (36V) BRUSHLESS VACUUM KIT (see pg. 64-66)



INCREASED PERFORMANCE

COMPLIANT WITH OSHA STANDARD FOR EXPOSURE TO RESPIRABLE CRYSTALLINE SILICA (RULE 1926.1153)*



VC4710

12 Gallon Xtract Vac® Wet/Dry Dust Extractor/Vacuum

- Powerful 12 AMP Motor Generates 135 CFM and 92" of Water Lift
- Automatic Filter Cleaning System with dual filter blow-back is timed at set intervals to maintain consistent suction and longer filter life
- Efficient two stage filtration system with main nano filter set captures 99.95% particles 2 microns and larger
- On-board tool-activated power outlet starts and stops vacuum with a 10 second "off" delay to clear any remaining debris
- Soft start function for lower amp-draw at start-up
- Large, wide-set rear wheels and steel casters provide increased stability and mobility on the job-site
- *Complies with OSHA standard for Exposure Silica (rule 1926.1153) for select applications under the conditions that the specified equipment is used

VC4710 Includes: Main Flat Filters, 2/pk (P-79843), Anti-Static Hose, 1-3/8" x 16' (P-79865), Fleece Nano Filter Bag, 5/pk (P-78293), Disposable Bag, 5/pk (P-70297), Crevice Nozzle (W6084)

Gross Container Size	12 gal.
Wet Capacity	8 gal.
Air Flow Rate	135 CFM
Static Water Lift	92"
AMPS	12
Filter Cleaning	Yes
HEPA filter	Optional
Equipped Filter Efficiency	99.95% of 2 microns
Tool Activated Suction Start-Up?	Yes
Working Sound Level	59 dB(A)
Cord Length (ft)	24.6'
Dry Weight	27 lbs.
Shipping Weight	40.8 lbs.

POWER

12 AMP motor generates 135 CFM of suction power to take on the most challenging applications



PERFORMANCE

Automatic Filter Cleaning System with dual filter blow-back feature for consistent suction



XTRACT VAC ACCESSORIES

Description	Part #	Description	Part #
Main Flat Nano Filters (pair)	P-79843	Crevice Nozzle	W6084
 Main Flat HEPA Filters (pair) Tested filter efficiency certificate included	P-79859	Cuff Adapter for Hose P-79865 1-1/2" I.D. / 1-3/4" O.D.	P-70421
Fleece Nano Filters Bag (5/pk)	P-78293	Cuff Adapter for Hose P-70487 1" I.D. 1-3/8" / 1-1/2" O.D.	P-70415
Disposable Bag (5/pk)	P-70297	Quick Connect Adapter	P-70378
Anti-Static Hose 1-3/8" x 16' 1-1/2" I.D. / 1-3/4" O.D.	P-79865	Quick Connect Cuff	P-70384
Anti-Static Hose 1" x 11' - 6" I.D. 1-1/8" / O.D. 1-3/8"	P-70487	Flooring Set (8 pc.)	P-70312
3/4" x 10' Vacuum Hose I.D. 3/4" / O.D. 1" I.D. 1-1/2" / O.D. 1-3/4"	192108-A		

CONCRETE			
Application	Applicable Tools	Dust Attachment	Connection Adapter
DRILLING / CHIPPING / DEMOLITION	XRH01, XRH03, XRH04, XRH05, HR2641, HR2475, HR2811F	193472-7 Dust Extraction Attachment	192108-A 3/4"x10' Connector Hose
	XRH01, HR2641, XRH08, XRH10	195173-3 Dust Extraction Cup	
	HR4002, HR4510C	196074-8 Dust Extraction Attachment	
	HR4013C, XRH07	196537-4 Dust Extraction Attachment	
	HR5212C	196858-4 Dust Extraction Attachment, Demolition	
	HM0870C, HM1111C, HR4002, HR4510C, HR4041C	196571-4 Dust Extraction Attachment, Demolition	
	HM1203C, HM1214C, HR5212C		
HM1307CB, HM1317CB, HM1810, HM1812	197172-1 Dust Extraction Attachment, 1-1/8" Hex Shank, Demolition		
CUTTING / TUCK-POINTING	XAG13, XAG23ZU1, GA9040S	198509-5 9" Dust Extraction Cutting Guard	N/A
	9557 Series, 956 Series, GA502 Series	196846-1 5" Dust Extraction Tuck Point Guard	
	SJSII: GA5042C, GA4542C	196845-3 5" Dust Extraction Tuck Point Guard	
	9557 Series, 956 Series, GA502 Series	193794-5 5" Dust Extraction Cutting Guard	
	9557 Series, 956 Series, GA502 Series	192618-2 5" Dust Extraction Cutting Guard	
GRINDING / SURFACING	9557 Series, 956 Series, GA502 Series, XAG03, XAG04, XAG09, XAG11	195236-5 4-1/2" / 5" Dust Extraction Surface Grinding Shroud	192108-A 3/4"x10' Connector Hose
	PC5000C, PC5001C	Integrated	
	GA7011C, GA7040S, GA9040S	195386-6 7" Dust Extraction Surface Grinding Shroud	
DRYWALL CUTTING	XDS01	Integrated	192108-A 3/4"x10' Connector Hose
	XOC01, 3706	193449-2 Dust Extraction Cut-Out Base	

WOODWORKING			
Application	Applicable Tools	Dust Attachment	Connection Adapter
SANDING	XOB01/Z, B05030/K, B05031K, B05041/K, B06040, B06030, B06050J, B04556/K, B04900V, B03710, 9403, 9404., 9903, 9910, 9920	No Attachment Necessary	192108-A 3/4" x 10' Hose
	9032	122652-8	Direct Connection No Connector Necessary
MITER SAWS	XSL01/Z, LS0815F, LS1016/L/LX5, LS1018, LS1040, LS1216L/LX4, LS1221	No Attachment Necessary	Direct Connection No Connector Necessary
	LS1019L, XSL06, XSL04	P-070378	
CIRCULAR SAWS	5057KB, SP6000J/J1	No Attachment Necessary	Direct Connection No Connector Necessary
	XPS01PTJ/Z, XPS02ZU	P-070378	
	5008MGA	450079-5	
	XSH06/Z, XSH07/Z, XSH08/Z	196520-1	
	XSH04/Z, XSH05/Z	199230-9	
	XSH01X/Z, HS7600	196843-7	
	XSH03/Z	196952-2	
	XSS01/Z	419283-5	
XSS03/Z	194415-2		
JIG SAWS	JV0600K, 4329K, JV01W	No Attachment Necessary	192108-A 3/4" x 10' Hose
	4350FCT, 4351FCT, BJV180, XVJ01Z, XVJ02Z, XVJ03	417853-4	Direct Connection No Connector Necessary
PLATE JOINERS	PJ7000, 3901, XJP03	No Attachment Necessary	192108-A 3/4" x 10' Hose
ROUTERS	RD1101, RF1101/KIT, RP1101	193379-7	Direct Connection No Connector Necessary
	RP0900K, RT0700CX3, RT0701CX3, RT0701CX7, XTR01Z, XTR01T7	194733-8	
	RT0700C, RT0701C, RT0701CX3, RT0701CX7, XTR01Z, XTR01T7	195559-1	
	RP2301FC, RP1800	P-80023	
PLANERS	KP0810, LXP01, XPK01	No Attachment Necessary	Direct Connection No Connector Necessary
	KP0800K	451329-1	
	KP312	193733-5	



LXT BRUSHLESS

XCV05PT XCV05Z

18V X2 LXT® (36V) Brushless Backpack Dust Extractor/Vacuum Kit

- Powerful BL™ Brushless Motor generates 53 CFM of suction power and 28.5" of water lift
- Up to 90 minutes of continuous operation on low setting and 60 minutes on high setting using two 18V LXT® 5.0Ah batteries
- Efficient two stage HEPA filtration system captures 99.97% of particulates .3 microns and larger extending the life of the main filter

XCV05PT Includes: (2) 18V LXT® Lithium-Ion 5.0Ah Battery (BL1850B), 18V LXT® Lithium-Ion Dual Port Charger (DC18RD), Floor Nozzle (123486-2), Telescoping Extension Attachment (123584-2), Flexible Anti-Static Hose, 1" x 39" (143787-2), Harness (161479-1), Bent Pipe (123677-5), Crevice Nozzle (197900-4), Hose Band (166116-2), HEPA Filter (123636-9), Sleeve (456744-4), Filter Dust Bag

XCV05Z Includes: Tool only, battery & charger not included. Floor Nozzle (123486-2), Telescoping Extension Attachment (123584-2), Flexible Anti-Static Hose, 1" x 39" (143787-2), Harness (161479-1), Bent Pipe (123677-5), Crevice Nozzle (197900-4), Hose Band (166116-2), HEPA Filter (123636-9), Sleeve (456744-4), Filter Dust Bag

Gross Container Size	.5 gal.
Air Flow Rate	53 CFM
Static Water Lift	28.5"
Continuous Use (max, in minutes)	90 min.
Battery	2X 18V LXT® Lithium-Ion
HEPA filter	Yes
Equipped Filter Efficiency	99.97% of .3 microns
Working Sound Level	70 dB(A)
Dimensions (LxWxH)	7-1/4" x 9" x 14-3/4"
Net Weight (with battery)	9.4 lbs.
Shipping Weight	19.51 lbs.



LXT BRUSHLESS **AWS**

XCV10ZX

18V X2 LXT® (36V) BL™ 1/2 Gal. HEPA Filter Backpack Dust Extractor, AWS™ Capable

- Powerful BL™ Brushless Motor generates 64 CFM of suction power and 44" of water lift
- Up to 62 minutes of continuous operation on normal setting and 33 minutes on high setting using two 18V LXT® 5.0Ah batteries (batteries not included)
- Efficient two stage HEPA filter captures 99.97% of particulates .3 microns and larger extending the life of the main filter
- Auto-start Wireless System (AWS™) utilizes Bluetooth® technology for wireless power-on/off communication between tool and dust extractor
- Includes the 3 tool adapters for hose connection to most Makita dust extraction attachments

XCV10ZX Includes: Tool only, battery & charger not included. Flexible Hose, 1" x 59" (152992-0), HEPA Filter (123636-9), Tool Cuff Adapter, 22mm for 1" hose (417765-1), Tool Cuff Adapter, 24mm for 1" hose (424379-9), Tool Cuff Adapter, 38mm for 1" hose (417766-9), HEPA Filter (123636-9), Harness (161479-1), Flexible Hose, 1" x 59" (152992-0), Filter Dust Bag

Gross Container Size	.5 gal.
Air Flow Rate	64 CFM
Static Water Lift	44"
Continuous Use (max, in minutes)	62 min.
Battery	2X 18V LXT® Lithium-Ion
HEPA filter	Yes
Equipped Filter Efficiency	99.97% of .3 microns
Working Sound Level	69 dB(A)
Dimensions (LxWxH)	7-1/4" x 9" x 14-3/4"
Net Weight (with battery)	10 lbs.
Shipping Weight	10.01 lbs.



LXT

XCV02Z

18V LXT® 3/4 Gallon Portable Dry Dust Extractor/Blower

- Makita-built motor delivers 49 CFM and 24" water lift of suction using an 18V LXT® Lithium-Ion battery (battery not included)
- Up to 42 minutes of continuous operation using a fully charged 18V 5.0Ah LXT® battery (battery not included)
- Two tools in one; quickly converts from dust extractor to a blower by attaching blower nozzle for added versatility
- Portable design with shoulder strap; weighs only 5.3 lbs. with 18V LXT® battery (battery not included)
- Dust cloth bag with 3/4 gallon capacity for maximum debris extraction easily detaches to discard collected material

XCV02Z Includes: Tool only, battery & charger not included. Anti-Static Hose, 1" x 8.2" (140456-6), Dust Bag (122918-6), Rubber Blower Nozzle (132025-7), Shoulder Strap (166094-6), Tool Cuff Adapter, 38mm for 1" hose (417766-9), Tool Cuff Adapter, 22mm for 1" hose (417765-1)

Gross Container Size	.75 gal.
Air Flow Rate	49 CFM
Static Water Lift	24"
Continuous Use (max, in minutes)	42 min.
Battery	18V LXT® Lithium-Ion
Working Sound Level	84 dB(A)
Dust Blower	Yes
Max. Air Velocity	210 MPH
Dimensions (LxWxH)	15-7/8" x 7-5/8" x 8-7/8"
Net Weight (with battery)	5.3 lbs.
Shipping Weight	7.94 lbs.



LXT BRUSHLESS **AWS**

XCV08PT XCV08Z

18V X2 LXT® (36V) Brushless 2.1 Gal HEPA Filter Dry Dust Extractor/Vac Kit, AWS™

- Powerful BL™ Brushless motor delivers 74 CFM and 39" water lift of suction using two 18V LXT® Lithium-Ion batteries
- Efficient three stage HEPA filtration system captures 99.97% of particulates .3 microns and larger
- Filter cleaning system is designed to maintain optimal suction efficiency and longer filter life

XCV08PT Includes: 18V X2 LXT® (36V) Brushless 2.1 Gal. HEPA Filter Dry Dust Extractor/Vacuum, AWS™ (XCV08Z), (2) 18V LXT® Lithium-Ion 5.0Ah Battery (BL1850B), 18V LXT® Lithium-Ion Dual Port Charger (DC18RD), Anti-Static Hose, 1-1/2" x 8" (195434-1), Curved Tube (192562-3), Straight Tube (192553-1), Floor Nozzle (122512-4), Crevice Nozzle (410306-2), Anti-Static Hose, 1" x 11" (195433-3), Tool Cuff Adapter, 22mm for 1" hose (417765-1), Tool Cuff Adapter, 24mm for 1" hose (424379-9), Tool Cuff Adapter, 38mm for 1" hose (417766-9), Plastic Disposal Bag, 10/pk (195432-5), HEPA Filter (197166-6), HEPA Filter (197166-6), Damper Filter (423398-2), Pre-Filter (195553-3)

XCV08Z Includes: Same as XCV08PT except does not include battery & charger

Gross Container Size	2.1 gal.
Air Flow Rate	74 CFM
Static Water Lift	39"
Continuous Use (max, in minutes)	75 min.
Battery	2X 18V LXT® Lithium-Ion
HEPA filter	Yes
Equipped Filter Efficiency	99.97% of .3 microns
Automatic-start Wireless System (AWS™)	Yes
Working Sound Level	66 dB(A)
Net Weight (with battery)	18.4 lbs.
Shipping Weight	35.94 lbs.



LXT BRUSHLESS **AWS**

XCV07PTX XCV07ZX

18V X2 LXT® (36V) Brushless 2.1 Gallon HEPA Filter Dry Dust Extractor Kit

- Powerful Makita BL™ Brushless motor delivers 74 CFM and 39" water lift of suction using two 18V LXT® Lithium-Ion batteries
- Efficient three stage HEPA filtration system captures 99.97% of particulates .3 microns and larger
- Up to 75 minutes of run time on low setting and 40 minutes on high setting using two 18V LXT® 5.0Ah batteries

XCV07PTX Includes: 18V X2 LXT® (36V) Brushless 2.1 Gallon HEPA Filter Dry Dust Extractor (XCV07ZX), (2) 18V LXT® Lithium-Ion 5.0Ah Battery (BL1850B), 18V LXT® Lithium-Ion Dual Port Charger (DC18RD), Anti-Static Hose, 1" x 11" (195433-3), Tool Cuff Adapter, 22mm for 1" hose (417765-1), Tool Cuff Adapter, 24mm for 1" hose (424379-9), Tool Cuff Adapter, 38mm for 1" hose (417766-9), Plastic Disposal Bag, 10/pk (195432-5), HEPA Filter (197166-6), Damper Filter (423398-2), Pre-Filter (195553-3)

XCV07ZX Includes: Same as XCV07PTX except does not include battery & charger

Gross Container Size	2.1 gal.
Air Flow Rate	74 CFM
Static Water Lift	39"
Continuous Use (max, in minutes)	75 min.
Battery	2X 18V LXT® Lithium-Ion
Filter Cleaning	Yes
HEPA filter	Yes
Equipped Filter Efficiency	99.97% of .3 microns
Working Sound Level	66 dB(A)
Net Weight (with battery)	18.4 lbs.
Shipping Weight	31.97 lbs.



LXT X2 18V + 18V 36V

XCV04Z

18V X2 LXT® (36V) 2.1 Gallon HEPA Filter Dry Dust Extractor/Vacuum

- Powerful Makita-built motor delivers 127 CFM and 96" water lift of suction using corded power
- Powerful Makita-built motor delivers 74 CFM and 36" water lift of suction using two 18V LXT® Lithium-Ion batteries (batteries not included)
- Efficient three stage HEPA filtration system captures 99.97% of particulates .3 microns and larger extending the life of the main filter
- Filter cleaning system is designed to maintain optimum suction efficiency and longer filter life

XCV04Z Includes: Tool only, battery & charger not included. Anti-Static Hose, 1-1/2" x 8" (195434-1), Curved Tube (192562-3), Straight Tube (192563-1), Crevice Nozzle (410306-2), Floor Nozzle (122512-4), Anti-Static Hose, 1" x 11" (195433-3), Tool Cuff Adapter, 24mm for 1" hose (424379-9), Tool Cuff Adapter, 22mm for 1" hose (417765-1), Tool Cuff Adapter, 38mm for 1" hose (417766-9), Plastic Disposal Bag, 10/pk (195432-5), HEPA Filter (197166-6), Damper Filter (423398-2), Pre-Filter (195553-3)

Gross Container Size	2.1 gal.
Air Flow Rate	127 CFM
Static Water Lift	96"
Continuous Use (max, in minutes)	65 min.
Battery	2X 18V LXT® Lithium-Ion
AMPS	9.2
Filter Cleaning	Yes
HEPA filter	Yes
Equipped Filter Efficiency	99.97% of .3 microns
Working Sound Level	64 dB(A)
Net Weight (with battery)	21.8 lbs.
Shipping Weight	33.3 lbs.



LXT BRUSHLESS













XCV11T XCV11Z







18V LXT® Brushless 2 Gal. HEPA Filter Portable Wet/Dry Dust Extractor/Vacuum Kit

- Powerful BL™ Brushless motor delivers 57 CFM and 27" water lift of suction using an 18V LXT® Lithium-Ion battery
- Filter cleaning system is designed to maintain optimum suction efficiency and longer filter life
- Efficient HEPA filter captures 99.97% of particulates .3 microns and larger
- Up to 60 minutes of continuous run time using an 18V LXT® Lithium-Ion 5.0Ah battery (BL1850B)
- Compact and portable design with shoulder strap; weighs only 10.1 lbs. with 18V LXT® battery (shoulder strap not included)

XCV11T Includes: 18V LXT® Lithium-Ion Rapid Optimum Charger (DC18RC), 18V LXT® Lithium-Ion 5.0Ah Battery (BL1850B), Round Wet/Dry HEPA Filter (162518-0), Pre-Filter Set, XCV11Z (199827-4), 5" Black Upholstery Nozzle (458919-1), 7" Black Crevice Nozzle (458919-1), Anti-Static Flexible Hose, 1" x 6.5" (140604-3)

Gross Container Size	2 gal.
Air Flow Rate	57 CFM
Static Water Lift	27"
Continuous Use (max, in minutes)	60 min.
Battery	18V LXT® Lithium-Ion
Filter Cleaning	Yes
HEPA filter	Yes
Equipped Filter Efficiency	99.97% of .3 microns
Working Sound Level	76 dB(A)
Net Weight (with battery)	10.1 lbs.

XCV04Z / XCV07ZX / XCV08Z / XCV05ZX / XCV10ZX			
Application	Applicable Tools	Dust Attachment	Connection Adapter
SDS-PLUS DRILLING	XRH01, XRH03, XRH04, XRH05, XRH06, RH01, RH02, HR2641, HR2475, HR2811F	193472-7 Dust Extraction Attachment 	417765-1 (Included with Extractor)
	XRH06, RH01, RH02, XRH12	199245-6 Dust Extraction Cup 	
	XRH01, HR2641, XRH08, XRH10	195173-3 Dust Extraction Cup 	
SDS-MAX DRILLING	HR4002, HR4510C	196074-8 Dust Extraction Attachment 	417765-1 (Included with Extractor)
	HR4013C, XRH07	196537-4 Dust Extraction Attachment 	
	HR5212C	196858-4 Dust Extraction Attachment 	
MEDIUM DUTY CHIPPING / DEMOLITION	HR4002, HR4510C	196074-8 Dust Extraction Attachment 	417765-1 (Included with Extractor)
	HR4013C, XRH07	196537-4 Dust Extraction Attachment 	
	HR5212C	196858-4 Dust Extraction Attachment 	
	HM0870C, HM1111C, HR4002, HR4510C, HR4013C, HR4041C	196571-4 Dust Extraction Attachment, Demolition 	
	HM1203C, HM1214C		
HEAVY DUTY CHIPPING / DEMOLITION	HM1307CB, HM1317CB, HM1810, HM1812	197172-1 Dust Extraction Attachment, 1-1/8" Hex Shank, Demolition 	417766-9 (Included with Extractor)

XCV04Z			
Application	Applicable Tools	Dust Attachment	Connection Adapter
4-1/2" - 5" CUTTING / TUCK-POINTING	XAG13, XAG23ZU1 GA9040S	198509-5 9" Dust Extraction Cutting Guard 	417766-9 (Included with Extractor)
	9557 Series, 9564 Series, GA502 Series, XAG03, XAG04, XAG09, XAG11	196846-1 5" Dust Extraction Tuck Point Guard 	
	SJSII: GA5042C, GA4542C	196845-3 5" Dust Extraction Tuck Point Guard 	
	9557 Series, 9564 Series, GA502 Series, XAG03, XAG04, XAG09, XAG11	192618-2 5" Dust Extraction Cutting Guard 	
	9557 Series, 9564 Series, GA502 Series, XAG03, XAG04, XAG09, XAG11	193794-5 5" Dust Extraction Cutting Guard 	
	4-1/2" - 5" GRINDING / SURFACING	9557 Series, 9565 Series, GA502 Series, XAG03, XAG04, XAG09, XAG11	
PC5000C, PC5001C		Integrated	
FIBER-CEMENT BOARD CUTTING	5057KB	Integrated	417766-9 (Included with Extractor)
DRYWALL CUTTING <small>(NOT APPLICABLE TO OSHA RESPIRABLE CRYSTALLINE SILICA RULES)</small>	XDS01	Integrated	417765-1 (Included with Extractor)
	XOC01, 3706	193449-2 Dust Extraction Cut-Out Base 	



LXT[™] BRUSHLESS

XCV06Z

18V X2 LXT[™] (36V) Brushless 2.1 Gallon Wet/Dry Dust Extractor/Vacuum

- Powerful Makita BL[™] Brushless motor delivers 74 CFM using two 18V LXT[™] Lithium-Ion batteries (batteries not included)
- Up to 75 minutes of continuous run time on low setting and 40 minutes on high setting using two 18V LXT[™] 5.0Ah batteries (batteries not included)
- Efficient BL[™] Brushless motor is electronically controlled to optimize battery energy use for up to 50% longer run time per charge
- Oversized on-off switch for operator convenience
- Motor chamber constructed of quality sound-absorbing materials for quiet operating sound levels of 66 dB(A)

XCV06Z Includes: Tool only, battery & charger not included
Anti-Static Hose, 1-1/2" x 8' (195434-1), Curved Tube (192562-3), Straight Tube (192563-1), Floor Nozzle (122512-4), Crevice Nozzle (410306-2), Plastic Disposal Bag, 10/pk (195432-5), Cloth Vacuum Filter (140248-3)

Gross Container Size	2.1 gal.
Wet Capacity	1.5 gal.
Air Flow Rate	74 CFM
Static Water Lift	39"
Continuous Use (max, in minutes)	75 min.
Battery	2X 18V LXT [™] Lithium-Ion
Filter Cleaning	No
HEPA filter	No
Working Sound Level	66 dB(A)
Net Weight (with battery)	16.8 lbs.
Shipping Weight	25.3 lbs.



LXT[™] BRUSHLESS

XCV09PT

18V X2 LXT[™] (36V) Brushless 1/2 Gallon HEPA Filter Backpack Dry Vacuum Kit

- Powerful BL[™] Brushless Motor generates 70 CFM of suction power and 44" of water lift
- Up to 116 minutes of continuous operation on normal setting using two 18V LXT[™] 5.0Ah batteries
- Efficient two stage HEPA filter captures 99.97% of particulates .3 microns and larger extending the life of the main filter

XCV09PT Includes: 18V X2 LXT[™] (36V) Brushless 1/2 Gallon HEPA Filter Backpack Dry Vacuum (XCV09Z), (2) 18V LXT[™] Lithium-Ion 5.0Ah Battery (BL1850B), 18V LXT[™] Lithium-Ion Dual Port Charger (DC18RD), Flexible Anti-Static Hose, 1" x 39" (143787-2), HEPA Filter (123636-9), Crevice Nozzle (197900-4), Floor Nozzle (127052-8), Bent Pipe (127093-3), Aluminum Telescoping Extension Wand (140G19-0), Harness (162469-7), Sleeve (456744-4), Filter Dust Bag

XCV09Z Includes: Tool only, battery & charger not included
Flexible Anti-Static Hose, 1" x 39" (143787-2), HEPA Filter (123636-9), Crevice Nozzle (197900-4), Sleeve (456744-4), Floor Nozzle (127052-8), Bent Pipe (127093-3), Aluminum Telescoping Extension Wand (140G19-0), Harness (162469-7), Filter Dust Bag

Gross Container Size	.5 gal.
Air Flow Rate	70 CFM
Static Water Lift	44"
Continuous Use (max, in minutes)	116 min.
Battery	2X 18V LXT [™] Lithium-Ion
HEPA filter	Yes
Equipped Filter Efficiency	99.97% of .3 microns
Working Sound Level	69 dB(A)
Dimensions (LxWxH)	7-1/4" x 9" x 14-3/4"
Net Weight (with battery)	9.9 lbs.
Shipping Weight	20.15 lbs.



LXT[™] BRUSHLESS

DRC200PT

18V X2 LXT[™] Brushless Robotic Vacuum Kit

- Cleans approximately 5,380 square feet of hard floor surfaces using two 18V LXT[™] 5.0Ah batteries BL1850B
- Up to 200 minutes of continuous operation on hard floors in "Main Brush plus Vacuum" mode using two 18V LXT[™] 5.0Ah batteries
- Efficient BL[™] Brushless motor is electronically controlled to optimize battery energy use for up to 50% longer run time per charge
- Three stage cleaning system utilizes side brushes, main brush and vacuum suction to ensure complete cleaning performance

DRC200PT Includes: 18V X2 LXT[™] Brushless Robotic Vacuum (DRC200Z), (2) 18V LXT[™] Lithium-Ion 5.0Ah Battery (BL1850B), 18V LXT[™] Lithium-Ion Dual Port Charger (DC18RD), Boundary Tape (SH00000240), High Efficiency Filter (SH00000213), Wireless Remote Control (SH00000238)

DRC200Z Includes: Tool only, battery & charger not included
Boundary Tape (SH00000240), High Efficiency Filter (SH00000213), Wireless Remote Control (SH00000238)

Gross Container Size	.66 gal.
Cleaning Width	8-7/8"
Cleaning Width (with side brushes)	18-1/16"
Working Sound Level	64 dB(A)
Continuous Use (max, in minutes)	200 min.
Battery	2X 18V LXT [™] Lithium-Ion
Dimensions (LxWxH)	18-1/8" x 18-1/8" x 7-1/8"
Net Weight (with battery)	17.2 lbs.
Shipping Weight	33 lbs.



LXT[™]

XLC01ZB

18V LXT[™] Vacuum

- Up to 60 minutes of continuous use from a single fully charged 18V 5.0Ah LXT[™] battery (battery not included)
- Powerful motor generates 35 CFM of suction power
- Push button power selection for (high/low) operation
- Accepts disposable paper or cloth dust bags for easier cleaning
- Compact and ergonomic design at only 19" long
- Weighs only 2.9 lbs. with battery (battery not included) for reduced operator fatigue

XLC01ZB Includes: Tool only, battery & charger not included
Paper Filter, 5/pk (194566-1), Dust Bag (166084-9)

Capacity (pint)	1 pint
Continuous Use (max, in minutes)	60 min.
Battery	18V LXT [™] Lithium-Ion
Overall Length	19"
Net Weight (with battery)	2.9 lbs.
Shipping Weight	4.07 lbs.



LXT[™] COMPACT

XLC02R1B

18V LXT[™] Compact Vacuum Kit

- Up to 13 minutes of continuous use from a single fully charged 18V Compact Lithium-Ion 2.0Ah battery
- Redesigned floor nozzle for improved maneuverability and debris collection
- Strong suction power for fast and efficient cleaning
- Bagless 2-stage cloth filtration system allows for easier cleaning and quicker debris disposal
- Increased storage capacity for longer time between waste disposal

XLC02R1B Includes: 18V LXT[™] Vacuum (XLC02ZB), 18V LXT[™] Lithium-Ion Compact 2.0Ah Battery (BL1820B), 18V LXT[™] Lithium-Ion Rapid Optimum Charger (DC18RC), Filter (451208-3), Cloth Vacuum Filter (443060-3), Floor Nozzle (123539-7), Crevice Nozzle Holder (456585-8), 6" Black Crevice Nozzle (456586-6), Extension Attachment (456587-4)

XLC02ZB Includes: Tool only, battery & charger not included
Filter (451208-3), Cloth Vacuum Filter (443060-3), Floor Nozzle (123539-7), Crevice Nozzle Holder (456585-8), 6" Black Crevice Nozzle (456586-6), Extension Attachment (456587-4)

Capacity (pint)	1.3 pint
Continuous Use (max, in minutes)	15 min.
Battery	18V LXT [™] Compact Lithium-Ion
Overall Length	18-3/4"
Net Weight (with battery)	2.7 lbs.
Shipping Weight	7.9 lbs.



LXT[™] COMPACT

XLC02RB1W

18V LXT[™] Compact Vacuum Kit

- Up to 20 minutes of continuous run time with 2.0Ah Compact Lithium-Ion battery
- Redesigned floor nozzle for improved maneuverability and debris collection
- Strong suction power for fast and efficient cleaning
- Bagless 2-stage cloth filtration system allows for easier cleaning and quicker debris disposal
- Increased storage capacity for longer time between waste disposal
- Compact and ergonomic design at only 18-3/4" long

XLC02RB1W Includes: 18V LXT[™] Compact Vacuum (XLC02ZBW), 18V LXT[™] Lithium-Ion Compact 2.0Ah Battery (BL1820B), 18V LXT[™] Lithium-Ion Rapid Optimum Charger (DC18RC), Extension Attachment (451242-7), Floor Nozzle (122858-8), Crevice Nozzle (451240-7), Filter (451208-3), Cloth Vacuum Filter (443060-3)

XLC02ZW Includes: Tool only, battery & charger not included
Extension Attachment (451241-5), Floor Nozzle (122858-8), Crevice Nozzle (451240-7), Filter (451208-3), Cloth Vacuum Filter (443060-3)

Capacity (pint)	1.3 pint
Continuous Use (max, in minutes)	20 min.
Battery	18V LXT [™] Compact Lithium-Ion
Overall Length	18-3/4"
Net Weight (with battery)	2.7 lbs.
Shipping Weight	7.26 lbs.

DRC200 ACCESSORIES

SH00000238

Wireless Remote Control

- Remote control provides wireless capability to set most operating functions including location beacon



SH00000240

Boundary Tape

- Detection sensor technology communicates floor conditions such as obstacles, cliff avoidance or boundary tape lines



SH00000213

High Efficiency Filter

- Rated at 99% efficiency
- Fully washable for ease of maintenance



CYCLONIC VACUUM ATTACHMENT

199553-5

Cyclonic Vacuum Attachment

- Cyclonic action captures up to 90% of dust particles
- Reduces need to empty vacuum main canister/filter by up to 84%
- One-touch release for easy disposal of debris
- 360° positioning for access in tight spaces
- Fits all 18V LXT[™] and 12V CX[™] hand vacuums

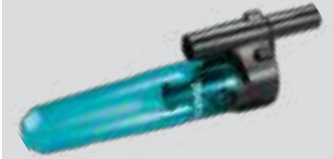

LXT[™] BRUSHLESS

DCL501Z

18V LXT[™] Brushless Cyclonic Canister Vacuum

- Powerful motor generates 46 CFM of suction power and 26.5" of water lift
- Up to 64 minutes of continuous operation using a 5.0Ah LXT[™] battery (battery not included)
- Efficient BL[™] Brushless motor is electronically controlled to optimize battery energy use for up to 50% longer run time per charge
- The BL[™] Brushless Motor eliminates carbon brushes, enabling the BL[™] Motor to run cooler and more efficiently for longer life
- Cyclonic filtration system collects dust, separating the large debris particles in the dust cup and filtering micro particles through the HEPA filter

DCL501Z Includes: Tool only, battery & charger not included
Suction Hose (SH00000034), Floor Nozzle (SH00000058), Telescoping Extension Attachment (SH00000060), Crevice Nozzle (SH00000042), Shoulder Strap (166124-3)

Capacity (pint)	.53 pint
Air Flow Rate	46 CFM
Static Water Lift	26.5"
Continuous Use (max, in minutes)	64 min.
Battery	18V LXT [™] Lithium-Ion
Working Sound Level	64 dB(A)
Dimensions (LxWxH)	13-7/8" x 7-7/16" x 9-7/8"
Net Weight (with battery)	8.4 lbs.
Shipping Weight	9.9 lbs.



XWT08T // 18V LXT® BRUSHLESS HIGH TORQUE 1/2" SQUARE DRIVE IMPACT WRENCH KIT (see pg. 18)
XSFO3T // 18V LXT® BRUSHLESS 4,000 RPM DRYWALL SCREWDRIVER KIT (see pg. 70)



6407

3/8" Drill

- Powerful 4.9 AMP motor for improved performance
- Variable speed (0 - 2,500 RPM) for drilling in a wide variety of materials
- In-line handle design for better control
- Reversing switch is conveniently located
- All ball bearing construction for longer tool life
- Large trigger switch for easy operation

6407 Includes: 3/8" Drill Chuck (763136-3), Chuck Key (763423-0)

Capacity (steel)	3/8"
Capacity (wood)	1"
No Load Speed (variable speed)	0 - 2,500 RPM
AMPS	4.9
Overall Length	10-9/32"
Net Weight	3.1 lbs.
Shipping Weight	4 lbs.



6408 shown

6408 / 6408K

3/8" Drill

- Powerful 4.9 AMP motor
- Keyless chuck for fast and easy bit installation and removal
- Low decibel rating (79dB) for quieter operation
- Variable speed (0 - 2,500 RPM) for drilling in a wide variety of materials
- In-line handle design for improved performance
- Large trigger switch for easy operation

6408 Includes: 3/8" Keyless Drill Chuck (763132-1)

6408K Includes: 3/8" Keyless Drill Chuck (763132-1), Tool Case (824043-A)

Capacity (steel)	3/8"
Capacity (wood)	1"
No Load Speed (variable speed)	0 - 2,500 RPM
AMPS	4.9
Overall Length	10-9/32"
Net Weight	3.1 lbs.
Shipping Weight:	6408 (4 lbs.), 6408K (6.7 lbs.)



6302H

1/2" Drill

- Powerful 6.5 AMP motor for improved performance
- Variable speed (0 - 550 RPM) for drilling in a wide variety of materials
- Heavy duty industrial 1/2" drill chuck engineered for positive bit retention
- Compact and lightweight (4.8 lbs.)
- Large, multi-position side handle for operator comfort and control
- Large and conveniently located lock-on button

6302H Includes: Drill Chuck (763145-2), Chuck Key (763434-5), Side Handle (122593-8)

Capacity (steel)	1/2"
Capacity (wood)	1-3/8"
No Load Speed (variable speed)	0 - 550 RPM
AMPS	6.5
Overall Length	11-1/4"
Net Weight	4.8 lbs.
Shipping Weight	5.6 lbs.



DP4000

1/2" Drill

- Powerful 7.0 AMP motor for improved performance
- Variable speed for drilling in a wide variety of materials
- Retractable belt clip allows operation in tight areas
- Ergonomically designed rubberized grips for comfort
- Side handle rotates 360° for comfort and control
- Ball and needle bearing construction for longer tool life

DP4000 Includes: Drill Chuck (193229-6), Chuck Key (763430-3), Side Handle (134903-7)

Capacity (steel)	1/2"
Capacity (wood)	1-1/2"
No Load Speed (variable speed)	0 - 950 RPM
AMPS	7
Overall Length	12"
Net Weight	4.8 lbs.
Shipping Weight	6.4 lbs.



DP4002

1/2" Drill

- Powerful 7.0 AMP motor for improved performance
- Variable speed for drilling in a wide variety of materials
- Retractable belt clip allows operation in tight areas
- Ergonomically designed rubberized grips for comfort
- Side handle rotates 360° for comfort and control
- Lightweight aluminum gear housing for durability

DP4002 Includes: Drill Chuck (193229-6), Chuck Key (763430-3), Side Handle (134903-7)

Capacity (steel)	1/2"
Capacity (wood)	1-1/2"
No Load Speed (variable speed)	0 - 700 RPM
AMPS	7
Overall Length	12"
Net Weight	4.9 lbs.
Shipping Weight	6.7 lbs.



DS4011

1/2" Spade Handle Drill

- Powerful 8.5 AMP motor for improved mixing and drilling performance
- All-ball bearing construction for durability and longer tool life
- Heavy duty industrial 1/2" drill chuck engineered for positive bit retention
- Rocker switch for quick transition between forward and reverse operation
- On-board chuck key storage for fast and convenient bit changes
- 600 RPM provides increased speed and torque for drilling large holes

DS4011 Includes: Drill Chuck (193229-6), Chuck Key (763420-6), Side Handle (152492-0)

Capacity (steel)	1/2"
Capacity (wood)	1-1/2"
No Load Speed	600 RPM
AMPS	8.5
Overall Length	13-3/8"
Net Weight	6.3 lbs.
Shipping Weight	7.4 lbs.



DS4000

1/2" Spade Handle Drill

- Durable all metal motor housing is jobsite tough yet lightweight
- Rocker switch for quick transition between forward and reverse operation
- Precision ground metal gears engineered to withstand the rigors of rotation changes
- 12" pipe handle with rubberized grip for greater control and improved ergonomics
- Powerful 9.0 AMP motor delivers 500 RPM and provides aggressive torque to match the job
- D-handle rotates 360° with 24 positive stops for multi-position operation

DS4000 Includes: Drill Chuck (193319-5), Chuck Key (763434-5), Side Handle (152492-0)

Capacity (steel)	1/2"
Capacity (wood)	1-1/2"
No Load Speed	500 RPM
AMPS	9
Overall Length	14-1/4"
Net Weight	8.8 lbs.
Shipping Weight	13.2 lbs.



DS4012

1/2" Spade Handle Drill

- Variable speed (0 - 600 RPM) for mixing and drilling in a wide variety of materials
- Forward and reverse lever for operator convenience
- Well-balanced design at only 6.2 lbs. for reduced operator fatigue
- D-handle rotates 360° with 24 detent stops for multi-position operation

DS4012 Includes: Drill Chuck (193229-6), Chuck Key (763420-6), Side Handle (152492-0)

Capacity (steel)	1/2"
Capacity (wood)	1-1/2"
No Load Speed (variable speed)	0 - 600 RPM
AMPS	8.5
Overall Length	13-3/8"
Net Weight	6.2 lbs.
Shipping Weight	7.4 lbs.

DRILL ACCESSORIES

Industrial Carbide-Tipped Hole Saws

- Lasts 15X longer and drills 2.6X faster than bi-metal hole saws
- Specially designed carbide tips for cutting clean holes
- Max. cutting depth of 1/8" with 2-1/2" overall length

Expandable Range of Applications (Type "C" Cobalt included)

- Stainless Steel
- Galvanized Iron
- Aluminum, etc.



Diameter	Part #	Center Bits Type C Part #
5/8"	714070-A	
3/4"	714071-A	
7/8"	714073-A	
1"	714074-A	
1-1/8"	714075-A	
1-1/4"	714077-A	714086-A
1-3/8"	714078-A	
1-1/2"	714079-A	
1-3/4"	714080-A	
2"	714081-A	
2-1/8"	714092-A	
2-1/4"	714082-A	
2-1/2"	714083-A	
3"	714085-A	

SEE MORE // pg.130-133



DA4000LR

1/2" Angle Drill

- Powerful 7.5 AMP motor for improved performance
- 2-Speed (0 - 400 & 0 - 900 RPM) for increased drilling versatility
- 360° angle attachment for drilling in any position
- Ergonomically designed rubberized grip for comfort
- All ball bearing construction for longer tool life
- Large multi-position side handle for operator comfort and control

DA4000LR Includes: Drill Chuck (193319-5), Chuck Key (763434-5), Side Handle (152892-4), Key Holder (410102-8), Hex Wrench 5 (783216-9), Tool Case (824646-6), Drill Head Handle (122646-3)

Capacity (steel)	1/2"
Capacity (wood)	1-1/2"
No Load Speed (2 spd)	400/900 RPM
AMPS	7.5
Overall Length	16-1/4"
Net Weight	8.1 lbs.
Shipping Weight	17.5 lbs.



DA3010F

3/8" Angle Drill

- Powerful 4 AMP motor for improved performance
- Variable speed (0 - 2,400 RPM) for drilling in a wide variety of materials
- Compact design (10-5/8" long and 2-5/8" head width) for use when working between framing studs and other close quarter applications
- Paddle switch with speed limiting dial to prevent over-tightening of fasteners
- Built-in clutch engineered to prevent gear damage by automatically disengaging gears if the bit binds

DA3010F Includes: Drill Chuck (763174-5), Chuck Key (763415-9), Key Holder (411780-7), Side Handle (153489-2)

Capacity (steel)	3/8"
Capacity (wood)	13/16"
No Load Speed (variable speed)	0 - 2,400 RPM
AMPS	4
Overall Length	10-5/8"
Net Weight	3.5 lbs.
Shipping Weight	4.21 lbs.



DA4031

1/2" Angle Drill

- Powerful 10 AMP motor for improved performance
- 2-Speed (300 & 1,200 RPM) for increased drilling versatility
- Sidewinder® handle rotates 90° left or right
- Built-in clutch reduces gear damage by disengaging gears if the bit binds (low speed only)
- Adjustable top handle with hex wrench storage
- Ergonomically designed rubberized grip for reduced operator fatigue

DA4031 Includes: Drill Chuck (193319-5), Chuck Key (763434-5), Key Holder (410102-8), Wrench (783204-6), Side Handle (273654-8)

Capacity (steel)	1/2"
Capacity (wood)	1-1/2"
No Load Speed (2 spd)	300/1,200 RPM
AMPS	10
Overall Length	18-1/4"
Net Weight	12.3 lbs.
Shipping Weight	22.3 lbs.

SUPERIOR SPEED, MAX EFFICIENCY

PERFORMANCE

Drills up to 160 2-9/16" holes per charge in 2x SPF*

SPEED

Delivers no-load drilling speeds of 0-350 RPM and 0-1,400 RPM for maximum efficiency



LXT BRUSHLESS

XAD03PT

18V X2 LXT® (36V) Brushless 1/2" Right Angle Drill Kit

- Drills up to 160 2-9/16" holes per charge in 2x SPF* (*with two 5.0Ah batteries and self feed bit, (self feed bit sold separately)
- Automatic Speed Change™ technology adjusts drill speed and torque during drilling for optimum performance
- Extreme Protection Technology (XPT™) is engineered for improved dust and water resistance for operation in harsh conditions
- Metal-gear housing increases tool durability and extends reliability
- Variable 2-speed design (0-350 RPM and 0-1,400 RPM) for optimum speed control and drilling versatility
- Torque limiter; built-in clutch reduces gear damage by disengaging gears if the bit binds (low speed only)
- Electric brake for maximum productivity
- Built-in L.E.D. light illuminates the work area
- Adjustable top handle for easy positioning

XAD03PT Includes: 18V X2 LXT® (36V) Brushless 1/2" Right Angle Drill (XAD03Z), (2) 18V LXT® Lithium-Ion 5.0Ah Battery (BL1830B), 18V LXT® Lithium-Ion Dual Port Charger (DC18RD), Tool Bag (631271-6), Side Handle (126802-7), Wrench (783204-6), Drill Chuck (763250-5), Chuck Key (763251-3)

XAD03Z Includes: Tool only, battery & charger not included Side Handle (126802-7), Wrench (783204-6), Drill Chuck (763250-5), Chuck Key (763251-3)

Capacity (wood, w/ hole saw)	6-1/4"
Capacity (wood, w/ ship auger bit)	2"
Capacity (wood, w/ self feed bit)	4-5/8"
No Load Speed (var. 2 spd)	0 - 350 / 1 - 1,400 RPM
Battery	2X 18V LXT® Lithium-Ion
Overall Length	21-1/4"
Net Weight (with battery)	14 lbs.
Chuck Size	1/2"
Chuck Type	Keyed
Shipping Weight	29 lbs.



LXT

XAD02

18V LXT® 3/8" Angle Drill Kit

- Makita-built 4-pole motor delivers 121 in.lbs. of Max Torque
- Variable speed (0-1,800 RPM) for a wide range of drilling and driving applications
- 3/8" keyless chuck for fast and easy bit installation and removal
- Compact 3-1/2" angle head height for use in close quarters
- Compact and ergonomic design at only 12-3/8" long
- Weighs only 4.0 lbs. with battery for reduced operator fatigue

XAD02 Includes: 18V LXT® 3/8" Angle Drill (XAD02Z), (2) 18V LXT® Lithium-Ion 3.0Ah Battery (BL1830B), 18V LXT® Lithium-Ion Rapid Optimum Charger (DC18RC), Tool Bag

XAD02Z Includes: Tool only, battery & charger not included

Capacity (steel)	3/8"
Capacity (wood)	1"
No Load Speed (variable speed)	0 - 1,800 RPM
Maximum Torque (in.lbs./N•m)	121 in.lbs./14N•m
Battery	18V LXT® Lithium-Ion
Overall Length	12-3/8"
Net Weight (with battery)	4 lbs.
Shipping Weight	13.45 lbs.



LXT

XAD01

18V LXT® 3/8" Angle Drill Kit

- Makita-built 4-pole motor delivers 121 in.lbs. of Max Torque
- Variable speed (0-1,800 RPM) for a wide range of drilling and driving applications
- 3/8" keyed metal chuck for improved bit gripping power
- Compact 2-5/8" angle head height for use in close quarters
- Compact and ergonomic design at only 12-3/8" long
- Weighs only 4.0 lbs. with battery for reduced operator fatigue

XAD01 Includes: 18V LXT® 3/8" Angle Drill (XAD01Z), (2) 18V LXT® Lithium-Ion 3.0Ah Battery (BL1830), 18V LXT® Lithium-Ion Rapid Optimum Charger (DC18RC), Chuck Key Holder (450688-0), Chuck Key (763415-9), Tool Bag

XAD01Z Includes: Tool only, battery & charger not included Chuck Key Holder (450688-0), Chuck Key (763415-9)

Capacity (steel)	3/8"
Capacity (wood)	1"
No Load Speed (variable speed)	0 - 1,800 RPM
Maximum Torque (in.lbs./N•m)	121 in.lbs./14N•m
Battery	18V LXT® Lithium-Ion
Overall Length	12-3/8"
Net Weight (with battery)	4 lbs.
Shipping Weight	13.45 lbs.



FS6200

6,000 RPM Drywall Screwdriver

- Powerful 6.0 AMP motor with 0-6,000 RPM to handle the most challenging applications
- Less weight (only 3.0 lbs.) with precision balance for ultimate user comfort
- Built-in L.E.D. light illuminates the work area for greater productivity in low-light applications
- Steel-reinforced belt clip for user convenience and increased durability
- Adjustable depth locator assembly with Sure-Lock™ feature for consistent screw depth
- Directional air-flow vents channel the tool's air output away from the user's face

FS6200 Includes: 3" Magnetic Bit Holder (784801-1), #2 Phillips Insert Bit, 1", 10/pk (784211-B)

Bit Type	1/4" Hex
No Load Speed (variable speed)	0 - 6,000 RPM
AMPS	6
Overall Length	11-1/8"
Net Weight	3 lbs.
Shipping Weight	3.086 lbs.



FS4200

4,000 RPM Drywall Screwdriver

- Powerful 6.0 AMP motor with 0-4,000 RPM to handle the most challenging applications
- Less weight (only 3.0 lbs.) with precision balance for ultimate user comfort
- Built-in L.E.D. light illuminates the work area for greater productivity in low-light applications
- Steel-reinforced belt clip for user convenience and increased durability
- Adjustable depth locator assembly with Sure-Lock™ feature for consistent screw depth
- Directional air-flow vents channel the tool's air output away from the user's face

FS4200 Includes: 3" Magnetic Bit Holder (784801-1), #2 Phillips Insert Bit, 1", 10/pk (784211-B)

Bit Type	1/4" Hex
No Load Speed (variable speed)	0 - 4,000 RPM
AMPS	6
Overall Length	11-1/8"
Net Weight	3 lbs.
Shipping Weight	4 lbs.



FS2200

2,500 RPM Drywall Screwdriver

- Powerful 6.0 AMP motor with 0-2,500 RPM to handle the most challenging applications
- Less weight (only 3.5 lbs.) with precision balance for ultimate user comfort
- Built-in L.E.D. light illuminates the work area for greater productivity in low-light applications
- Steel-reinforced belt clip for user convenience and increased durability
- Adjustable depth locator assembly with Sure-Lock™ feature for consistent screw depth
- Cast aluminum gear housing for less weight and increased durability

FS2200 Includes: 3" Magnetic Bit Holder (784801-1), #2 Phillips Insert Bit, 1", 10/pk (784211-B)

Bit Type	1/4" Hex
No Load Speed (variable speed)	0 - 2,500 RPM
AMPS	6
Overall Length	11-1/8"
Net Weight	3.5 lbs.
Shipping Weight	3.306 lbs.



FS2500

2,500 RPM Screwdriver

- Powerful 6.0 AMP motor with 0-2,500 RPM to handle the most challenging applications
- Less weight (only 3.4 lbs.) with precision balance for ultimate user comfort
- Built-in L.E.D. light illuminates the work area for greater productivity in low-light applications
- Steel-reinforced belt clip for user convenience and increased durability
- Adjustable depth locator assembly with Sure-Lock™ feature for consistent screw depth
- Cast aluminum gear housing for less weight and increased durability

FS2500 Includes: 5/16" Magnetic Nutsetter, 2-5/8" (784804-5)

Bit Type	1/4" Hex
No Load Speed (variable speed)	0 - 2,500 RPM
AMPS	6
Overall Length	11"
Net Weight	3.4 lbs.
Shipping Weight	3.306 lbs.



FS2701

2,500 RPM Torque Adjustable Screwdriver

- Powerful 6.0 AMP motor with 0-2,500 RPM with increased torque for side lapping, metal decking and heavy gauge applications
- Six stage torque clutch adjustment helps prevent fastener overdriving and material damage
- Built-in LED light illuminates the work area for greater productivity in low-light applications
- Large trigger with lock-on button located mid-handle for operator convenience
- Ergonomically designed rubberized "pistol grip" for increased comfort
- Cast aluminum gear housing for less weight and increased durability

FS2701 Includes: 5/16" Magnetic Nutsetter, 2-5/8" (784804-5)

Bit Type	1/4" Hex
No Load Speed (variable speed)	0 - 2,500 RPM
AMPS	6
Overall Length	11-1/8"
Net Weight	4 lbs.
Shipping Weight	3.306 lbs.



XSF05T

18V LXT® Brushless 2,500 RPM Screwdriver Kit

- Brushless motor delivers 0-2,500 RPM with increased torque to handle high demand fastening applications
- The electronically-controlled BL™ Brushless Motor efficiently uses energy to match torque and RPM to the changing demands of the application
- Push Drive™ Technology – in lock-on mode the motor starts only when the fastener is engaged for a quieter work environment and to save battery power
- Depth adjustable nose piece with 5/16" nutsetter delivers consistent screw fastening performance

XSF05T Includes: 18V LXT® Brushless 2,500 RPM Screwdriver (XSF05Z), (2) 18V LXT® Lithium-Ion 5.0Ah Battery (BL1850B), 18V LXT® Lithium-Ion Rapid Optimum Charger (DC18RC), Belt Clip (346449-3), 5/16" Magnetic Nutsetter, 2-5/8" (784804-5), Tool Case

Bit Type	1/4" Hex
No Load Speed (variable speed)	0 - 2,500 RPM
Battery	18V LXT® Lithium-Ion
Overall Length	9-3/8"
Net Weight (with battery)	3.9 lbs.
Shipping Weight	13 lbs.



XSF03TX2

18V LXT® Brushless 4,000 RPM Drywall Screwdriver Kit, with Autofeed Magazine

- Push Drive™ Technology – in lock-on mode the motor starts only when the fastener engages for longer runtime and motor noise reduction
- BL™ Motor delivers 0-4,000 RPM to handle a variety of drywall and framing applications
- Included: Collated Screw Magazine with easy and reliable auto-feed capability is ideal for production drywall hanging
- Collated screw length capacity range from 1" to 2-3/16" for increased versatility

XSF03TX2 Includes: 18V LXT® Brushless 4,000 RPM Drywall Screwdriver (XSF03Z), (2) 18V LXT® Lithium-Ion 5.0Ah Battery (BL1850B), 18V LXT® Lithium-Ion Rapid Optimum Charger (DC18RC), 3" Magnetic Bit Holder (784812-6), Collated Autofeed Screwdriver Magazine (199145-0), Belt Clip (346449-3), Tool Bag, (2) #2 Phillips Power Bit, (2) #2 Square Power Bit

Bit Type	1/4" Hex
No Load Speed (variable speed)	0 - 4,000 RPM
Collated Screw Capacity	1" - 2-3/16"
Battery	18V LXT® Lithium-Ion
Overall Length	16"
Net Weight (with battery)	4.7 lbs.
Power Type	Cordless
Torque adjustment	No



XSF03RX2

18V LXT® Compact Brushless 4,000 RPM Drywall Screwdriver Kit with Autofeed Magazine

- Push Drive™ Technology – in lock-on mode the motor starts only when the fastener engages for longer runtime and motor noise reduction
- BL™ Motor delivers 0-4,000 RPM to handle a variety of drywall and framing applications
- Included: Collated Auto-Feed Screw Magazine with easy and reliable auto-feed capability is ideal for production drywall hanging

XSF03RX2 Includes: 18V LXT® Brushless 4,000 RPM Drywall Screwdriver (XSF03Z), (2) 18V LXT® Lithium-Ion Compact 2.0Ah Battery (BL1820B), 18V LXT® Lithium-Ion Rapid Optimum Charger (DC18RC), 3" Magnetic Bit Holder (784812-6), Collated Autofeed Screwdriver Magazine (199145-0), Belt Clip (346449-3), Tool Bag, (2) #2 Phillips Power Bit, (2) #2 Square Power Bit

Bit Type	1/4" Hex
No Load Speed (variable speed)	0 - 4,000 RPM
Collated Screw Capacity	1" - 2-3/16"
Battery	18V LXT® Compact Lithium-Ion
Overall Length	16"
Net Weight (with battery)	4.08 lbs.

BL MOTOR DELIVERS 0-4,000 RPM

DRIVES 2,325 SCREWS WITH PUSH DRIVE™ TECHNOLOGY USING 5.0Ah BATTERY BL1850B

LXT® BRUSHLESS

PUSH DRIVE



5.0 BATTERY



XSF03Z

TECHNOLOGY

BL™ Motor delivers 0-4,000 RPM to handle a variety of drywall and framing applications

PRODUCTIVITY

Push Drive™ – motor starts only when the fastener engages for longer run-time and noise reduction

XSF03TX2

18V LXT® Brushless 4,000 RPM Drywall Screwdriver Kit, with Autofeed Magazine

- Push Drive™ Technology – in lock-on mode the motor starts only when the fastener engages for longer run-time and motor noise reduction
- BL™ Motor delivers 0-4,000 RPM to handle a variety of drywall and framing applications
- Included: Collated Screw Magazine with easy and reliable auto-feed capability is ideal for production drywall hanging
- Collated screw length capacity range from 1" to 2-3/16" for increased versatility
- Optimized contact point geometry for close-to-corner screw positions
- All metal gears and aluminum gear housing for maximum job site durability
- Ergonomically designed rubberized pistol grip with large 2-finger trigger for increased comfort
- Built-in L.E.D. light illuminates the work area

XSF03TX2 Includes: Tool only, battery & charger not included
18V LXT® Brushless 4,000 RPM Drywall Screwdriver (XSF03Z), (2) 18V LXT® Lithium-Ion 5.0Ah Battery (BL1850B), 18V LXT® Lithium-Ion Rapid Optimum Charger (DC18RC), 3" Magnetic Bit Holder (784812-6), Collated Autofeed Screwdriver Magazine (199145-0), Belt Clip (346449-3), Tool Bag, (2) #2 Phillips Power Bit, (2) #2 Square Power Bit

XSF03Z Includes: Tool only, battery & charger not included
3" Magnetic Bit Holder (784812-6), (2) Insert Bit

Bit Type	1/4" Hex
No Load Speed (variable speed)	0 - 4,000 RPM
Collated Screw Capacity	1" - 2-3/16"
Battery	18V LXT® Lithium-Ion
Overall Length	16"
Net Weight (with battery)	4.7 lbs.
Power Type	Cordless
Torque adjustment	No
Shipping Weight	

AUTOFEED SCREWDRIVER ACCESSORIES

NEW



Magazine only, tool sold separately

199145-0

Collated Autofeed Screwdriver Magazine

- Collated screw length capacity range from 1" to 2-3/16" for increased versatility
- Optimized contact point shape for close-to-corner screw positions
- Quick attachment and removal of collated magazine
- Screw depth dial adjustment for increased precision
- Screw strip can be released in reverse direction for easy screw clearance
- Compact and ergonomic design at only 8-7/8" long
- Designed for standard 50 screw flat strips

Designed for Makita cordless screwdriver models XSF03, XSF04 and corded screwdriver models FS2200, FS4200, FS6200

Autofeed Screwdriver 30" Extension Handle

Model	Part #
6834	192501-3
6844, BFR750, XRF01	194500-1

SCREWDRIVER ACCESSORIES

Description	Size	Model	Part #
Nose Cone		FS2200, FS4200/A/TP, FS6200/TP, XSF03, XSF04	195542-8
Drywall Adapter		XDT01, XDT08, XDT04, XDT09	194633-2
Locator	5/16"	FS2500, XSF05	450967-6
	For Power Bits	6827	322120-3

CUT-OUT TOOL ACCESSORIES

Industrial Cut-Out Bits

Description	Size	Qty. /Pkg.	Model	Part #
Drywall/ Guide Tip	1/8"	10	3706, XOC01	193452-3
Window/Door	1/4"	1		193453-1

Circular Guide

Description	Model	Part #
Cleaner, more precise circle/arc cuts up to 14" in diameter	3706, XOC01	193454-9

Collet Cone Adapter

Description	Size	Model	Part #
Collet Cone	1/4"		763608-8
	1/8"	3706	763660-6
	1/4"		763676-1
	1/8"	XOC01	763677-9



2.0 BATTERY



LXT® COMPACT BRUSHLESS PUSH DRIVE

XSF03R

XSF03Z

18V LXT® Compact Brushless 4,000 RPM Drywall Screwdriver Kit

- BL™ Motor delivers 0-4,000 RPM to handle a variety of drywall and framing applications
- Push Drive™ Technology – in lock-on mode the motor starts only when the fastener engages for efficient battery use and increased drywall installation
- Ergonomically designed rubberized pistol grip with large 2-finger trigger for increased comfort
- Adjustable nose piece delivers consistent screw depth
- 3-stage L.E.D. gauge indicates battery charge level
- Built-in L.E.D. light illuminates the work area

XSF03R Includes: 18V LXT® Brushless 4,000 RPM Drywall Screwdriver (XSF03Z), (2) 18V LXT® Lithium-Ion Compact 2.0Ah Battery (BL1820B), 18V LXT® Lithium-Ion Rapid Optimum Charger (DC18RC), 3" Magnetic Bit Holder (784812-6), Tool Case, (2) Insert Bit

XSF03Z Includes: Tool only, battery & charger not included
3" Magnetic Bit Holder (784812-6), (2) Insert Bit

Bit Type	1/4" Hex
No Load Speed (variable speed)	0 - 4,000 RPM
Battery	18V LXT® Compact Lithium-Ion
Overall Length	9-7/8"
Net Weight (with battery)	3.2 lbs.
Shipping Weight	12 lbs.



2.0 BATTERY



LXT® COMPACT BRUSHLESS PUSH DRIVE

XSF04R

XSF04Z

18V LXT® Compact Brushless 2,500 RPM Drywall Screwdriver Kit

- Brushless motor delivers 0-2,500 RPM with increased torque to handle high demand fastening applications
- The electronically-controlled BL™ Brushless Motor efficiently uses energy to match torque and RPM to the changing demands of the application
- Push Drive™ Technology – in lock-on mode the motor starts only when the fastener is engaged for a quieter work environment and to save battery power
- Depth adjustable nose piece delivers consistent screw fastening performance

XSF04R Includes: 18V LXT® Brushless 2,500 RPM Drywall Screwdriver (XSF04Z), (2) 18V LXT® Lithium-Ion Compact 2.0Ah Battery (BL1820B), 18V LXT® Lithium-Ion Rapid Optimum Charger (DC18RC), Belt Clip (346449-3), 3" Magnetic Bit Holder (784812-6), (2) #2 Phillips Insert Bit, 1" (784211), Tool Case

XSF04Z Includes: Tool only, battery & charger not included
Belt Clip (346449-3), 3" Magnetic Bit Holder (784812-6), (2) Insert Bit

Bit Type	1/4" Hex
No Load Speed (variable speed)	0 - 2,500 RPM
Battery	18V LXT® Compact Lithium-Ion
Overall Length	9-3/8"
Net Weight (with battery)	3.5 lbs.
Shipping Weight	12 lbs.



Screws not included

LXT®

XRF02Z

18V LXT® Autofeed Screwdriver

- Makita-built 4-pole motor delivers superior fastening speed with 4,000 RPM for decking and sub-floor applications
- High collated screw capacity range: 1" to 2-1/8"
- Screw guide prevents screw strip tangling and can fold against the autofeed housing for easy storing
- Rugged aluminum dust-proof autofeed housing provides smooth sliding action
- Compact and ergonomic design at only 16-1/4" long
- Weighs only 5.1 lbs. with battery (battery not included) for reduced operator fatigue

XRF02Z Includes: Tool only, battery & charger not included
#2 Phillips Power Bit, 6-3/8" (B-10481-1), (2) #2 Square Power Bit, 6-3/8" (784645-9), Extension Handle (194500-1)

Bit Type	1/4" Hex
No Load Speed	4,000 RPM
Collated Screw Capacity	1" - 2-3/16"
Battery	18V LXT® Lithium-Ion
Overall Length	16-3/4"
Net Weight (with battery)	4.6 lbs.
Shipping Weight	5.1 lbs.



3706 shown

Also Available:
Dust Extracting
Cut-Out Base
193449-2



3706 / 3706K

Drywall Cut-Out Tool

- Powerful 5 AMP motor for cutting into various material
- 32,000 RPM for faster cutting
- 2-way "Slide and Bump" on/off switch
- Sealed switch for extra protection from dust and debris and longer tool life
- "Tool-less" depth adjustment sets the desired cutting depth quickly and easily
- Slim body design (2-1/4" diameter) for comfort and control

3706 Includes: Spanner Wrench (781008-0), 1/4" Collet (763608-8), 1/8" Collet (763660-6), 2-Pc 1/8" Drywall Guide Tip Bit (733229-0)

3706K Includes: Drywall Cut-Out Tool (3706), Spanner Wrench (781008-0), 1/4" Collet (763608-8), 1/8" Collet (763660-6), 2-Pc 1/8" Drywall Guide Tip Bit (733229-0), Circular Guide (193454-9), Dust Nozzle (193455-7), Tool Case (A81675-7)

Collet Capacity	1/8", 1/4"
No Load Speed	32,000 RPM
AMPS	5
Overall Length	9-7/8"
Net Weight	2.4 lbs.
Shipping Weight:	3706 (3.1 lbs.), 3706K (5.6 lbs.)



6952

1/4" Impact Driver

- Variable speed trigger (0 - 3,200 RPM) for easy operation
- Impact resistant aluminum housing for gear protection and durability
- Compact and lightweight (3.1 lbs.) for both vertical and horizontal applications
- Rubberized pistol grip provides increased comfort on the job
- Dual ball bearings for longer tool life
- 2.3 AMP motor for high performance (0-3,100 IPM)

6952 Includes: Belt Clip (324284-9), Tool Case (824630-1)

Hex Shank	1/4"
Impacts Per Minute (variable speed)	0 - 3,100 IPM
No Load Speed (variable speed)	0 - 3,200 RPM
Maximum Torque (ft.lbs./N•m)	120 ft.lbs./162 N•m
AMPS	2.3
Overall Length	9"
Net Weight	3.1 lbs.
Shipping Weight	6.6 lbs.



6953

1/2" Impact Wrench w/ Detent Pin Anvil

- All metal hammer casing to withstand all environments
- Externally accessible brushes for easy replacement
- 0 - 3,000 impacts per minute for maximum efficiency
- Compact length for easier handling and operator control
- Convenient belt clip attaches to both sides of the tool
- Ideal for garage door installers, metal framers and deck builders

6953 Includes: Belt Clip (324284-9), Plastic Tool Case (824703-0)

Capacity (square drive)	1/2"
Impacts Per Minute (variable speed)	0 - 3,000 IPM
No Load Speed (variable speed)	0 - 3,000 RPM
Maximum Torque (ft.lbs./N•m)	110 ft.lbs./150 N•m
AMPS	2.5
Overall Length	9-1/8"
Net Weight	3.3 lbs.
Shipping Weight	6.6 lbs.



TW0200

1/2" Impact Wrench w/ Detent Pin Anvil

- Variable speed 0 - 2,200 RPM for controlled fastening
- Efficient impact system with less vibration
- Externally accessible brushes for easy replacement
- Precision gearing with ball and needle bearing construction for smooth and efficient power transmission
- Compact and lightweight (4.9 lbs.) for use in close quarters
- Impact-resistant aluminum gear case with rubber boot for increased durability

TW0200 Includes: Belt Clip (324284-9), Plastic Tool Case (824703-0)

Capacity (square drive)	1/2"
Impacts Per Minute (variable speed)	0 - 2,200 IPM
No Load Speed (variable speed)	0 - 2,200 RPM
Maximum Torque (ft.lbs./N•m)	150 ft.lbs./200 N•m
AMPS	3.3
Overall Length	9-7/8"
Net Weight	4.9 lbs.
Shipping Weight	8.8 lbs.



TW0350

1/2" Impact Wrench w/ Detent Pin Anvil

- Powerful 3.5 AMP motor delivers 2,000 RPM/IPM for heavy duty applications
- Efficient impact system with less vibration
- Externally accessible brushes for easy replacement
- Precision gearing with ball and needle bearing construction for efficient power transmission
- Compact and lightweight (6.6 lbs.) for use in close quarters
- Impact resistant aluminum gear housing with rubber boot for increased durability

TW0350 Includes: Belt Clip (324284-9), Tool Case (824702-2)

Capacity (square drive)	1/2"
Impacts Per Minute	2,000 IPM
No Load Speed (variable speed)	0 - 2,000 RPM
Maximum Torque (ft.lbs./N•m)	258 ft.lbs./350 N•m
AMPS	3.5
Overall Length	11-1/8"
Net Weight	6.6 lbs.
Shipping Weight	11 lbs.



6906

3/4" Impact Wrench w/ Friction Ring Anvil

- Powerful 9.0 AMP motor delivers 1,700 RPM for heavy duty applications
- Precision gearing with ball and needle bearing construction for smooth and efficient power transmission
- Rocker switch with forward/reverse operation for user convenience
- Side handle rotates 360° for operator convenience
- Externally accessible brushes for easy replacement
- Impact-resistant aluminum gear case with rubber boot for increased durability

6906 Includes: Side Handle (122464-9), Steel Tool Case (823023-9)

Capacity (square drive)	3/4"
Impacts Per Minute	1,600 IPM
No Load Speed	1,700 RPM
Maximum Torque (ft.lbs./N•m)	433 ft.lbs./588 N•m
AMPS	9
Overall Length	12-7/8"
Net Weight	12.3 lbs.
Shipping Weight	22 lbs.



TW1000

1" Impact Wrench w/ Friction Ring Anvil

- Max torque of 738 ft.lbs.
- Efficient impact system with less vibration
- Externally accessible brushes for easy replacement, and ball bearings for longer tool life
- Side handle rotates 360° for operator convenience
- Impact resistant aluminum gear housing with rubber boot for protection and increased durability
- Rocker switch with forward/reverse operation for user convenience

TW1000 Includes: Tool Case (824737-3), Side Handle (123018-5)

Capacity (square drive)	1"
Impacts Per Minute	1,500 IPM
No Load Speed	1,400 RPM
Maximum Torque (ft.lbs./N•m)	738 ft.lbs./1,000 N•m
AMPS	12
Overall Length	15"
Net Weight	19 lbs.
Shipping Weight	19.8 lbs.



6922NB

3/4" Shear Wrench

- Delivers 593 ft.lbs. of max torque for the most demanding applications
- Anti-slipping mechanism: tool won't start until inner sleeve engages with bolt tip
- Bolt tip ejecting lever located by power trigger for increased convenience
- Light weight design at only 10.6 lbs.
- Includes two outer sleeves and one inner sleeve for increased versatility
- Protective rubber bumper positioned at tool body for increased durability

6922NB Includes: Outer Sleeve, 3/4" (M20) x M37 (764361-9), Outer Sleeve, 7/8" (M22) x M39 (153909-6), Inner Sleeve, 7/8" (M22) x M39 (764418-6), Inner Sleeve, 3/4" (M20) x M38 (764419-4), Screwdriver (783001-0), Steel Tool Case (823276-0)

Bolt Size Capacity (A325)	5/8", 3/4", 7/8"
Bolt Size Capacity (A490)	5/8", 3/4"
No Load Speed	18 RPM
Lock-Off Switch	No
Maximum Torque (ft.lbs./N•m)	593 ft.lbs./804 N•m
Electric Brake	No
Overall Length	9-13/16"
Net Weight	10.6 lbs.
Shipping Weight	20.12 lbs.





GA4030 shown

GA4030 / GA4030K

4" Angle Grinder

- Powerful 6.0 AMP motor delivers 11,000 RPM
- Compact design at only 3.7 lbs.
- Labyrinth construction seals and protects motor and bearings
- Slide switch design with lock-on
- Ideal for welders, fabricators, masons, maintenance/repair and more

GA4030 Includes: 4" x 5/8" x 3/16" Grinding Wheel, 24 Grit (741402-B), 4" Wheel Guard (125885-4), Inner Flange (224377-1), Lock Nut (194608-1), Lock Nut Wrench (782420-7), Side Handle (153504-2)

GA4030K Includes: 4" x 5/8" x 3/16" Grinding Wheel, 24 Grit (741402-B), 4" Wheel Guard (125885-4), Lock Nut (194608-1), Lock Nut Wrench (782420-7), Inner Flange (224377-1), Side Handle (153504-2), Tool Case (824736-5)

Wheel Diameter	4"
AMPS	6
No Load Speed	11,000 RPM
Spindle Thread	M10 x 1.25
Lock-On Switch	Yes
Lock-Off Switch	No
Switch Type	Body grip/slide
Overall Length	10-1/2"
Net Weight	3.7 lbs.
Shipping Weight:	GA4030 (6.28 lbs.), GA4030K (8.1 lbs.)



GA4530

4-1/2" Angle Grinder

- Powerful 6.0 AMP motor delivers 11,000 RPM
- Compact design with small 2-1/4" diameter barrel and weighs only 4 lbs. for added comfort
- Labyrinth construction seals and protects motor and bearings
- Slide switch design with lock-on
- Protective zig-zag varnish seals the armature from dust and debris for longer tool life
- All-ball bearing design and metal gear housing for added durability

GA4530 Includes: 4-1/2" Grinding Wheel (A-95956), 4-1/2" Wheel Guard (122886-3), Lock Nut (194608-1), Lock Nut Wrench (782424-9), Inner Flange (224377-1), Side Handle (153504-2)

Wheel Diameter	4-1/2"
AMPS	6
No Load Speed	11,000 RPM
Spindle Thread	5/8" - 11 UNC
Lock-On Switch	Yes
Lock-Off Switch	No
Switch Type	Body grip/slide
Overall Length	10-1/2"
Net Weight	4 lbs.
Shipping Weight	6.28 lbs.



AC/DC

GA4534

4-1/2" Paddle Switch Angle Grinder

- Powerful 6.0 AMP motor delivers 11,000 RPM
- Compact design at only 4.2 lbs.
- Labyrinth construction seals and protects motor and bearings
- Paddle switch with no lock-on
- AC/DC switch for use with alternative power sources
- Protective zig-zag varnish seals the armature from dust and debris for longer tool life

GA4534 Includes: 4 1/2" Grinding Wheel (741423-B), 4-1/2" Wheel Guard (122886-3), Lock Nut Wrench (782424-9), Inner Flange (224399-1), Side Handle (153504-2), Lock Nut (224568-4)

Wheel Diameter	4-1/2"
AMPS	6
No Load Speed	11,000 RPM
Spindle Thread	5/8" - 11 UNC
Lock-On Switch	No
Lock-Off Switch	Yes
Switch Type	Body grip/paddle
Overall Length	10-3/8"
Net Weight	4.2 lbs.
Shipping Weight	6.05 lbs.



AC/DC

9557NB

4-1/2" Angle Grinder

- Powerful 7.5 AMP motor delivers 11,000 RPM for high output power
- Compact design with small 2-1/2" diameter barrel and weighs only 4.5 lbs. for added comfort
- Protective zig-zag varnish seals the armature from dust and debris for longer tool life
- Labyrinth construction seals and protects the drive gear and bearings from contamination
- AC/DC slide switch for use with alternative power source
- Slide switch with lock-on for continuous use

9557NB Includes: 4-1/2" Grinding Wheel (A-95956), 4-1/2" Wheel Guard (125273-5), Lock Nut (193465-4), Lock Nut Wrench (782422-3), Inner Flange (224399-1), Side Handle (153489-2)

Wheel Diameter	4-1/2"
AMPS	7.5
No Load Speed	11,000 RPM
Spindle Thread	5/8" - 11 UNC
Lock-On Switch	Yes
Lock-Off Switch	No
Switch Type	Body grip/slide
Overall Length	10-5/8"
Net Weight	4.5 lbs.
Shipping Weight	6.28 lbs.



AC/DC

9557PB

4-1/2" Paddle Switch Angle Grinder

- Powerful 7.5 AMP motor delivers 11,000 RPM for high output power
- Compact design with small 2-1/2" diameter barrel and weighs only 4.5 lbs. for added comfort
- Protective zig-zig varnish seals the armature from dust and debris for longer tool life
- Labyrinth construction seals and protects the drive gear and bearings from contamination
- AC/DC paddle switch for use with alternative power sources

9557PB Includes: 4-1/2" Grinding Wheel (A-95956), 4-1/2" Wheel Guard (125273-5), Lock Nut (193465-4), Lock Nut Wrench (782422-3), Inner Flange (224399-1), Side Handle (153489-2)

Wheel Diameter	4-1/2"
AMPS	7.5
No Load Speed	11,000 RPM
Spindle Thread	5/8" - 11 UNC
Lock-On Switch	Yes
Lock-Off Switch	Yes
Switch Type	Body grip/paddle
Overall Length	10-3/4"
Net Weight	4.5 lbs.
Shipping Weight	6.39 lbs.



SJS™

9564P

4-1/2" SJS™ Paddle Switch Angle Grinder

- Powerful 10.0 AMP motor delivers more output and 10,500 RPM
- SJS™ technology is a mechanical clutch system that helps prevent motor and gear damage by allowing the drive shaft to slip
- Larger cooling fan and blades pull more air through the motor to help maintain lower operating temperature
- Large flush-mount paddle switch
- Labyrinth construction prevents debris from penetrating the motor, bearings and gears for longer tool life
- "Tool-less" wheel guard for more convenient adjustments

9564P Includes: 4-1/2" Tool-less Wheel Guard (135107-4), Lock Nut (193465-4), Lock Nut Wrench (782424-9), Inner Flange (224399-1), Side Handle (153489-2)

Wheel Diameter	4-1/2"
AMPS	10
No Load Speed	11,900 RPM
Spindle Thread	5/8" - 11 UNC
Lock-On Switch	No
Lock-Off Switch	Yes
Switch Type	Body grip/paddle
Overall Length	12-1/8"
Net Weight	5.1 lbs.
Shipping Weight	6.5 lbs.



SJS™

9564PC

4-1/2" SJS™ Paddle Switch Angle Grinder

- Powerful 13.0 AMP motor delivers more output and 10,500 RPM
- Constant speed control automatically applies additional power to the motor to maintain speed under load
- Electronic current limiter helps protect the motor from overload
- Large paddle switch with lock-off for comfortable operation
- "Tool-less" wheel guard adjustment for easy adjustment
- Alternate model 9565PC features a 5" guard

9564PC Includes: 4-1/2" Grinding Wheel (A-95956), 4-1/2" Tool-less Wheel Guard (135107-4), Lock Nut (193465-4), Lock Nut Wrench (782424-9), Inner Flange (224399-1), Side Handle (153489-2)

Wheel Diameter	4-1/2"
AMPS	13
No Load Speed	10,500 RPM
Spindle Thread	5/8" - 11 UNC
Lock-On Switch	No
Lock-Off Switch	Yes
Switch Type	Body grip/paddle
Overall Length	12-1/8"
Net Weight	5.3 lbs.
Shipping Weight	7.2 lbs.



SJS™

9564CV

4-1/2" SJS™ Angle Grinder

- Powerful 13 AMP motor delivers more output and variable (2,800 - 10,500) RPM
- Variable speed control dial enables user to match the speed to the application
- Constant speed control automatically applies additional power to the motor to maintain speed under load
- Electronic current limiter helps protect the motor from overload
- Soft start suppresses start-up reaction for smooth start-ups and longer gear life
- Slide switch with lock-on setting for continuous use

9564CV Includes: 4-1/2" Grinding Wheel (A-95956), 4-1/2" Tool-less Wheel Guard (135107-4), Lock Nut (193465-4), Lock Nut Wrench (782412-6), Inner Flange (224378-9), Side Handle (153489-2)

Wheel Diameter	4-1/2"
AMPS	13
No Load Speed (variable speed)	2,800 - 10,500 RPM
Spindle Thread	5/8" - 11 UNC
Lock-On Switch	Yes
Lock-Off Switch	No
Switch Type	Body grip/slide
Overall Length	11-3/4"
Net Weight	5.3 lbs.
Shipping Weight	7.3 lbs.

SJST™

LESS VIBRATION. MORE COMFORT.

Excessive vibration in a power tool is wasted motion which may affect a worker's comfort level and, ultimately, productivity. Makita is bringing unprecedented levels of vibration reduction to the grinder category with the exclusive SJS II™ Technology. SJS™ II is a leaf spring and cam gear drive mechanism that is engineered to reduce vibration for increased operator comfort during extended use. It works by transferring the vibration through the wheel accessory spindle and onto a CAM component. The vibration causes the a cam to press against the leaf spring and absorb vibration for increased operator comfort.

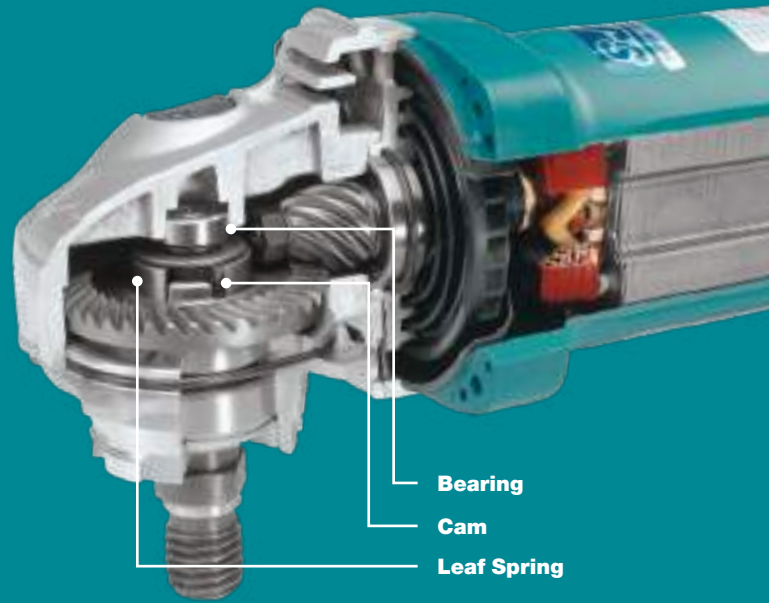

Bearing
Cam
Leaf Spring

PURPOSE-BUILT MOTORS



Makita-designed, engineered and built motors deliver power, efficiency and long life and were created for all your jobsite needs from maximum power to compact size

ZIG ZAG VARNISH



Makita's zig-zag and anti-dust varnish seals the motor from contamination

LABYRINTH CONSTRUCTION



Makita's labyrinth construction seals and protects the motor from dust and debris



SJST™

GA4542C

NEW POWER
12 AMP

4-1/2" SJS™ II Angle Grinder

- Powerful 12.0 AMP motor delivers more output and variable (2,800 - 11,000) RPM
- SJS™ II provides a leaf spring and cam gear drive mechanism that is engineered to reduce vibration for increased operator comfort during extended use
- Variable speed control dial enables user to match the speed to the application
- Electronic Controller is a three-part electronic feature designed to provide the required power in high torque applications for increased tool life
- Labyrinth construction seals and protects the drive gear and bearings from debris for increased durability
- Complete zig-zag epoxy is applied to both sides of the armature coil and a powder coating to the field for protection from debris and longer tool life

GA4542C Includes: 4-1/2" Grinding Wheel (A-95956), 4-1/2" Wheel Guard (123144-0), Inner Flange (224399-1), Lock Nut Wrench (782412-6), Side Handle (162258-0), Lock Nut (224568-4)

Wheel Diameter	4-1/2"
AMPS	12
No Load Speed (variable speed)	2,800 - 11,000 RPM
Spindle Thread	5/8" - 11 UNC
Lock-On Switch	Yes
Lock-Off Switch	No
Switch Type	Body grip/slide
Overall Length	11-7/8"
Net Weight	5.4 lbs.
Shipping Weight	8 lbs.



LXT™ BRUSHLESS

XAG04T

XAG04Z



18V LXT™ Brushless 4-1/2" / 5" Cut-Off/Angle Grinder Kit

- Automatic Speed Change™ technology adjusts speed and torque during operation for optimum performance
- Active Feedback-sensing Technology (AFT™) turns the motor off if rotation of the wheel is suddenly forced to stop
- The BL™ Brushless Motor eliminates carbon brushes, enabling the BL™ Motor to run cooler and more efficiently for longer life

XAG04T Includes: 18V LXT™ Brushless 4-1/2" / 5" Cut-Off/Angle Grinder (XAG04Z), (2) 18V LXT™ Lithium-Ion 5.0AH Battery (BL1850B), 18V LXT™ Lithium-Ion Rapid Optimum Charger (DC18RC), 5" x 1/4" x 7/8" INOX Grinding Wheel, 36 Grit (A-95962), 5" Ultra Thin Cut-Off Wheel, Stainless (B-46165), Side Handle (158237-4), Lock Nut Wrench (782424-9), 5" Cut-Off Wheel Guard (126686-3), 5" Tool-less Wheel Guard (126687-1), Side Handle, Tool Bag

XAG04Z Includes: Tool only, battery & charger not included 5" x 1/4" x 7/8" INOX Grinding Wheel, 36 Grit (A-95962), 5" Ultra Thin Cut-Off Wheel, Stainless (B-46165), Side Handle (158237-4), Lock Nut Wrench (782424-9), 5" Cut-Off Wheel Guard (126686-3), 5" Tool-less Wheel Guard (126687-1)

Wheel Diameter	5"
Battery	18V LXT™ Lithium-Ion
No Load Speed	8,500 RPM
Spindle Thread	5/8" - 11 UNC
Lock-On Switch	Yes
Lock-Off Switch	No
Switch Type	Body grip/slide
Overall Length	14-1/4"
Net Weight (with battery)	5.8 lbs.
Shipping Weight	15.5 lbs.



LXT™ BRUSHLESS

XAG09Z



18V LXT™ Brushless 4-1/2" / 5" Cut-Off/Angle Grinder

- Electric brake stops the grinding or cut-off wheel in 2 seconds or less for maximum productivity
- Active Feedback-sensing Technology (AFT™) turns the motor off if rotation of the wheel is suddenly forced to stop
- Automatic Speed Change™ technology adjusts speed and torque during operation for optimum performance
- The BL™ Brushless Motor eliminates carbon brushes, enabling the BL™ Motor to run cooler and more efficiently for longer life
- Efficient BL™ Brushless motor is electronically controlled to optimize battery energy use for up to 50% longer run time per charge

XAG09Z Includes: Tool only, battery & charger not included 5" x 1/4" x 7/8" INOX Grinding Wheel, 36 Grit (A-95962), 5" Ultra Thin Cut-Off Wheel, Stainless (B-46165), Side Handle (158237-4), Lock Nut Wrench (782424-9), 5" Cut-Off Wheel Guard (126686-3), 5" Tool-less Wheel Guard (126687-1)

Wheel Diameter	5"
Battery	18V LXT™ Lithium-Ion
No Load Speed	8,500 RPM
Spindle Thread	5/8" - 11 UNC
Lock-On Switch	Yes
Lock-Off Switch	No
Switch Type	Body grip/slide
Overall Length	14-1/4"
Net Weight (with battery)	5.7 lbs.
Shipping Weight	8 lbs.



LXT™ BRUSHLESS

XAG11T

XAG11Z



18V LXT™ Brushless 4-1/2" / 5" Cut-Off/Angle Grinder Kit

- Electric brake stops the grinding or cut-off wheel in 2 seconds or less for maximum productivity
- Active Feedback-sensing Technology (AFT™) turns the motor off if rotation of the wheel is suddenly forced to stop
- Automatic Speed Change™ technology adjusts speed and torque during operation for optimum performance

XAG11T Includes: 18V LXT™ Brushless 4-1/2" / 5" Cut-Off/Angle Grinder (XAG11Z), (2) 18V LXT™ Lithium-Ion 5.0AH Battery (BL1850B), 5" Cut-Off Wheel Guard (126686-3), 5" Tool-less Wheel Guard (126687-1), 18V LXT™ Lithium-Ion Rapid Optimum Charger (DC18RC), 5" x 1/4" x 7/8" INOX Grinding Wheel, 36 Grit (A-95962), 5" Ultra Thin Cut-Off Wheel, Stainless (B-46165), 14" Contractor Tool Bag (831253-8), Side Handle

XAG11Z Includes: Tool only, battery & charger not included 5" x 1/4" x 7/8" INOX Grinding Wheel, 36 Grit (A-95962), 5" Ultra Thin Cut-Off Wheel, Stainless (B-46165), Side Handle (158237-4), Lock Nut Wrench (782424-9), 5" Cut-Off Wheel Guard (126686-3), 5" Tool-less Wheel Guard (126687-1)

Wheel Diameter	5"
Battery	18V LXT™ Lithium-Ion
No Load Speed	8,500 RPM
Spindle Thread	5/8" - 11 UNC
Lock-On Switch	No
Lock-Off Switch	Yes
Switch Type	Body grip/paddle
Electric Brake	Yes
Variable speed control dial	No
Overall Length	14-1/4"
Net Weight (with battery)	5.8 lbs.
Shipping Weight	15 lbs.



LXT BRUSHLESS **XAG16Z**

18V LXT® Brushless 4-1/2" / 5" Cut-Off/Angle Grinder

- Electric Brake stops the grinding or cut-off wheel in 2 seconds or less for maximum productivity
- Active Feedback-sensing Technology (AFT™) turns the motor off if rotation of the wheel is suddenly forced to stop
- Automatic Speed Change™ technology adjusts speed and torque during operation for optimum performance
- The BL™ Brushless Motor eliminates carbon brushes, enabling the BL™ Motor to run cooler and more efficiently for longer life
- Variable speed control dial allows manual RPM adjustment (3,000-8,500) to match the speed to the application
- Soft start suppresses start-up reaction for smooth start-ups and longer gear life

XAG16Z Includes: Tool only, battery & charger not included
5" x 1/4" x 7/8" INOX Grinding Wheel, 36 Grit (A-95962), 5" Cut-Off Wheel Guard (126686-3), 5" Tool-less Wheel Guard (126687-1), Lock Nut Wrench (782424-9), Side Handle (158237-4)

Wheel Diameter	5"
Battery	18V LXT® Lithium-Ion
No Load Speed (variable speed)	3,000 - 8,500 RPM
Spindle Thread	5/8" - 11 UNC
Lock-On Switch	Yes
Lock-Off Switch	No
Switch Type	Body grip/slide
Electric Brake	Yes
Variable speed control dial	Yes
Overall Length	15"
Net Weight (with battery)	5.7 lbs.
Shipping Weight	7.4 lbs.



LXT BRUSHLESS **AWS** **XAG17ZU**

18V LXT® Brushless 4-1/2" / 5" Cut-Off/Angle Grinder, AWS™

- Electric Brake stops the grinding or cut-off wheel in 2 seconds or less for maximum productivity
- Active Feedback-sensing Technology (AFT™) turns the motor off if rotation of the wheel is suddenly forced to stop
- Automatic Speed Change™ technology adjusts speed and torque during operation for optimum performance
- Automatic-start Wireless System (AWS™) utilizes Bluetooth® technology for wireless power-on/off communication between tool and dust extractor
- The BL™ Brushless Motor eliminates carbon brushes, enabling the BL™ Motor to run cooler and more efficiently for longer life

XAG17ZU Includes: Tool only, battery & charger not included
5" x 1/4" x 7/8" INOX Grinding Wheel, 36 Grit (A-95962), 5" Cut-Off Wheel Guard (126686-3), 5" Tool-less Wheel Guard (126687-1), Lock Nut Wrench (782424-9), Auto-Start Wireless Transmitter (198901-5), Side Handle (158237-4)

Wheel Diameter	5"
Battery	18V LXT® Lithium-Ion
No Load Speed (variable speed)	3,000 - 8,500 RPM
Spindle Thread	5/8" - 11 UNC
Lock-On Switch	Yes
Lock-Off Switch	No
Switch Type	Body grip/slide
Electric Brake	Yes
Variable speed control dial	Yes
Automatic-start Wireless System (AWS™)	Yes (Transmitter Included)
Overall Length	15"
Net Weight (with battery)	5.7 lbs.
Shipping Weight	7.5 lbs.



LXT BRUSHLESS **XAG20Z**

18V LXT® Brushless 4-1/2" / 5" Paddle Switch Cut-Off/Angle Grinder

- Electric Brake stops the grinding or cut-off wheel in 2 seconds or less for maximum productivity
- Active Feedback-sensing Technology (AFT™) turns the motor off if rotation of the wheel is suddenly forced to stop
- Automatic Speed Change™ technology adjusts speed and torque during operation for optimum performance
- The BL™ Brushless Motor eliminates carbon brushes, enabling the BL™ Motor to run cooler and more efficiently for longer life
- Variable speed control dial allows manual RPM adjustment (3,000-8,500) to match the speed to the application
- Soft start suppresses start-up reaction for smooth start-ups and longer gear life

XAG20Z Includes: Tool only, battery & charger not included
5" x 1/4" x 7/8" INOX Grinding Wheel, 36 Grit (A-95962), 5" Cut-Off Wheel Guard (126686-3), 5" Tool-less Wheel Guard (126687-1), Lock Nut Wrench (782424-9), Side Handle (158237-4)

Wheel Diameter	5"
Battery	18V LXT® Lithium-Ion
No Load Speed (variable speed)	3,000 - 8,500 RPM
Spindle Thread	5/8" - 11 UNC
Lock-On Switch	No
Lock-Off Switch	Yes
Switch Type	Body grip/paddle
Electric Brake	Yes
Variable speed control dial	Yes
Overall Length	15"
Net Weight (with battery)	5.7 lbs.
Shipping Weight	7.6 lbs.



LXT BRUSHLESS **AWS** **XAG21ZU**

18V LXT® Brushless 4-1/2" / 5" Paddle Switch Cut-Off/Angle Grinder, AWS™

- Electric Brake stops the grinding or cut-off wheel in 2 seconds or less for maximum productivity
- Active Feedback-sensing Technology (AFT™) turns the motor off if rotation of the wheel is suddenly forced to stop
- Automatic Speed Change™ technology adjusts speed and torque during operation for optimum performance
- The BL™ Brushless Motor eliminates carbon brushes, enabling the BL™ Motor to run cooler and more efficiently for longer life

XAG21ZU Includes: Tool only, battery & charger not included
5" x 1/4" x 7/8" INOX Grinding Wheel, 36 Grit (A-95962), 5" Cut-Off Wheel Guard (126686-3), 5" Tool-less Wheel Guard (126687-1), Lock Nut Wrench (782424-9), Auto-Start Wireless Transmitter (198901-5), Side Handle (158237-4)

Wheel Diameter	5"
Battery	18V LXT® Lithium-Ion
No Load Speed (variable speed)	3,000 - 8,500 RPM
Spindle Thread	5/8" - 11 UNC
Lock-On Switch	No
Lock-Off Switch	Yes
Switch Type	Body grip/paddle
Electric Brake	Yes
Variable speed control dial	Yes
Automatic-start Wireless System (AWS™)	Yes (Transmitter Included)
Overall Length	15"
Net Weight (with battery)	5.7 lbs.
Shipping Weight	7.6 lbs.



SJS **GA5042C**

5" SJS™ II Angle Grinder

- Powerful 12.0 AMP motor delivers more output and variable (2,800 - 11,000) RPM
- SJS™ II provides a leaf spring and cam gear drive mechanism that is engineered to reduce vibration for increased operator comfort during extended use
- Variable speed control dial enables user to match the speed to the application
- Electronic Controller is a three-part electronic feature designed to provide the required power in high torque applications and increase tool life
- Labyrinth construction seals and protects the motor and bearings from dust and debris for longer tool life
- Complete zig-zag epoxy is applied to both sides of the armature coil and a powder coating to the field for protection from debris and longer tool life

GA5042C Includes: 5" x 1/4" x 7/8" INOX Grinding Wheel, 36 Grit (A-95962), 5" Tool-less Wheel Guard (123145-8), Inner Flange (224399-1), Lock Nut Wrench (782412-6), Side Handle (162258-0), Lock Nut (224568-4)

Wheel Diameter	5"
AMPS	12
No Load Speed (variable speed)	2,800 - 11,000 RPM
Spindle Thread	5/8" - 11 UNC
Lock-On Switch	Yes
Lock-Off Switch	No
Switch Type	Body grip/slide
Overall Length	11-7/8"
Net Weight	5.4 lbs.
Shipping Weight	8 lbs.



SJS **9558PB**

5" Paddle Switch Angle Grinder

- Powerful 7.5 AMP motor delivers 10,000 RPM for high output power
- Compact design with small 2-1/2" diameter barrel grip; weighs only 4.6 lbs. for added comfort
- Labyrinth construction seals and protects the drive gear from contamination for longer tool life
- AC/DC Switch for use with alternative power source
- Protective zig-zig varnish seals the armature from dust and debris for longer tool life

9558PB Includes: 5" x 1/4" x 7/8" INOX Grinding Wheel, 36 Grit (A-95962), (123734-9), Lock Nut (193465-4), Lock Nut Wrench (782422-3), Inner Flange (224399-1), Side Handle (153489-2)

Wheel Diameter	5"
AMPS	7.5
No Load Speed	10,000 RPM
Spindle Thread	5/8" - 11 UNC
Lock-On Switch	No
Lock-Off Switch	Yes
Switch Type	Body grip/paddle
Overall Length	10-3/4"
Net Weight	4.6 lbs.
Shipping Weight	6.62 lbs.



SJS **9565PCV**

5" SJS™ High-Power Paddle Switch Angle Grinder

- Powerful 13.0 AMP motor delivers more output and variable (2,800 - 10,500) RPM for the most demanding applications
- SJS™ technology is a mechanical clutch system that minimizes motor and gear damage by allowing the drive shaft to slip if the wheel is forced to stop
- Variable speed control dial enables user to match the speed to the application
- Electronic controller provides constant speed control which automatically applies additional power to the motor to maintain speed under load
- Electronic controller provides soft-start which is designed to suppress start-up reaction for smooth start-ups and longer gear life

9565PCV Includes: 5" x 1/4" x 7/8" INOX Grinding Wheel, 36 Grit (A-95962), 5" Tool-less Wheel Guard (135108-2), Lock Nut (193465-4), Lock Nut Wrench (782424-9), Inner Flange (224399-1), Side Handle (153489-2)

Wheel Diameter	5"
AMPS	13
No Load Speed (variable speed)	2,800 - 10,500 RPM
Spindle Thread	5/8" - 11 UNC
Lock-On Switch	No
Lock-Off Switch	Yes
Switch Type	Body grip/paddle
Overall Length	12-1/8"
Net Weight	4.2 lbs.
Shipping Weight	7.3 lbs.



SJS **9565CV**

5" SJS™ Angle Grinder

- Powerful 13.0 AMP motor delivers more output and variable (2,800 - 10,500) RPM
- Variable speed control dial enables user to match the speed to the application
- Constant speed control automatically applies additional power to the motor to maintain speed under load
- Soft start suppresses start-up reaction for smooth start-ups and longer gear life
- Electronic current limiter helps protect the motor from overload
- SJS™ technology is a mechanical clutch system that helps prevent motor and gear damage by allowing the drive shaft to slip

9565CV Includes: 5" x 1/4" x 7/8" INOX Grinding Wheel, 36 Grit (A-95962), 5" Tool-less Wheel Guard (135108-2), Lock Nut (193465-4), Lock Nut Wrench (782412-6), Inner Flange (224378-9), Side Handle (153489-2)

Wheel Diameter	5"
AMPS	13
No Load Speed (variable speed)	2,800 - 10,500 RPM
Spindle Thread	5/8" - 11 UNC
Lock-On Switch	Yes
Lock-Off Switch	No
Switch Type	Body grip/slide
Overall Length	11-3/4"
Net Weight	4 lbs.
Shipping Weight	7.4 lbs.



13 AMP

9565PC

5" SJS™ Paddle Switch Angle Grinder

- Powerful 13.0 AMP motor delivers more output and 10,500 RPM
 - Constant speed control automatically applies additional power to the motor to maintain speed under load
 - Electronic current limiter helps protect the motor from overload
 - Large no-lock-on paddle switch with lock-off for comfortable operation
 - "Tool-less" wheel guard adjustment for easy adjustment
 - Alternate model 9564PC features a 4-1/2" guard
- 9565PC Includes:** 5" x 1/4" x 7/8" INOX Grinding Wheel, 36 Grit (A-95962), 5" Tool-less Wheel Guard (135108-2), Lock Nut (193465-4), Lock Nut Wrench (782424-9), Inner Flange (224399-1), Side Handle (153489-2)

Wheel Diameter	5"
AMPS	13
No Load Speed	10,500 RPM
Spindle Thread	5/8" - 11 UNC
Lock-On Switch	No
Lock-Off Switch	Yes
Switch Type	Body grip/paddle
Overall Length	12-1/8"
Net Weight	5.3 lbs.
Shipping Weight	7.2 lbs.



AC/DC

9005B

5" Angle Grinder

- Lightweight (6.6 lbs.) for high production work with less fatigue
 - 9.0 AMP motor for powerful performance
 - Side handle can be installed on either side of the tool for operator convenience
 - Spindle lock for easy wheel changes
 - Lock-on feature for continuous operation
 - AC/DC for use with alternative power source
- 9005B Includes:** 5" x 1/4" x 7/8" INOX Grinding Wheel, 36 Grit (A-95962), 5" Wheel Guard (135549-2), Lock Nut (193465-4), Lock Nut Wrench (782412-6), Inner Flange (224378-9), Spindle Washer (261039-0), Side Handle (152492-0)

Wheel Diameter	5"
AMPS	9
No Load Speed	12,000 RPM
Spindle Thread	5/8" - 11 UNC
Lock-On Switch	Yes
Lock-Off Switch	No
Switch Type	Rear trigger switch
Overall Length	14"
Net Weight	6.6 lbs.
Shipping Weight	9.3 lbs.



AC/DC

9005BZ

5" Angle Grinder

- Lightweight (6.6 lbs.) for high production work with less fatigue
 - 9.0 AMP motor for powerful performance
 - Side handle can be installed on either side of the tool for operator convenience
 - Spindle lock for easy wheel changes
 - No lock-on feature for operator convenience
 - AC/DC switch for use with alternative power source
- 9005BZ Includes:** 5" x 1/4" x 7/8" INOX Grinding Wheel, 36 Grit (A-95962), 5" Wheel Guard (135549-2), Lock Nut (193465-4), Lock Nut Wrench (782412-6), Inner Flange (224378-9), Spindle Washer (261039-0), Side Handle (152492-0)

Wheel Diameter	5"
AMPS	9
No Load Speed	12,000 RPM
Spindle Thread	5/8" - 11 UNC
Lock-On Switch	No
Lock-Off Switch	No
Switch Type	Rear trigger switch
Overall Length	14"
Net Weight	6.6 lbs.
Shipping Weight	7 lbs.



AC/DC

GA5020

5" SJS™ Angle Grinder

- Powerful 10.5 AMP motor delivers 11,000 RPM to handle the most demanding applications
 - SJS™ technology is a mechanical clutch system that helps prevent motor and gear damage by allowing the drive shaft to slip
 - Electric brake for maximum productivity
 - Rear handle trigger switch with no-lock-on feature
 - Tool-less wheel guard for quick and easy adjustments
 - AC/DC switch for use with alternative power source
- GA5020 Includes:** 5" x 1/4" x 7/8" INOX Grinding Wheel, 36 Grit (A-95962), 5" Tool-less Wheel Guard (135108-2), Lock Nut (193465-4), Lock Nut Wrench (782424-9), Inner Flange (224399-1), Side Handle (153504-2)

Wheel Diameter	5"
AMPS	10.5
No Load Speed	11,000 RPM
Spindle Thread	5/8" - 11 UNC
Lock-On Switch	No
Lock-Off Switch	Yes
Switch Type	Rear trigger switch
Overall Length	14"
Net Weight	5.9 lbs.
Shipping Weight	8.8 lbs.



AC/DC

GA5020Y

5" SJS™ Angle Grinder

- Powerful 10.5 AMP motor delivers 11,000 RPM to handle the most demanding applications
 - SJS™ technology is a mechanical clutch system that helps prevent motor and gear damage by allowing the drive shaft to slip
 - Electric brake for maximum productivity
 - Rear handle trigger switch with no-lock-on feature
 - Tool-less wheel guard for quick and easy adjustments
 - AC/DC switch for use with alternative power source
- GA5020Y Includes:** 5" x 1/4" x 7/8" INOX Grinding Wheel, 36 Grit (A-95962), 5" Tool-less Wheel Guard (135108-2), Lock Nut (193465-4), Lock Nut Wrench (782424-9), Inner Flange (224399-1), Side Handle (153504-2)

Wheel Diameter	5"
AMPS	10.5
No Load Speed	11,000 RPM
Spindle Thread	5/8" - 11 UNC
Lock-On Switch	No
Lock-Off Switch	Yes
Switch Type	Rear trigger switch
Overall Length	14"
Net Weight	5.9 lbs.
Shipping Weight	7.9 lbs.



AC/DC

GA5010Z

5" Angle Grinder

- Powerful 10.5 AMP motor delivers more output for increased performance
 - Refined design at only 5.8 lbs.
 - AC/DC switch for use with alternative power source
 - Labyrinth construction seals and protects motor and bearings from contamination
 - Externally accessible brushes for greater serviceability
- GA5010Z Includes:** 5" x 1/4" x 7/8" INOX Grinding Wheel, 36 Grit (A-95962), 5" Tool-less Wheel Guard (135108-2), Lock Nut (193465-4), Lock Nut Wrench (782424-9), Inner Flange (224399-1), Side Handle (153504-2)

Wheel Diameter	5"
AMPS	10.5
No Load Speed	11,000 RPM
Spindle Thread	5/8" - 11 UNC
Lock-On Switch	No
Lock-Off Switch	No
Switch Type	Rear trigger switch
Overall Length	14"
Net Weight	5.8 lbs.
Shipping Weight	8.8 lbs.



13 AMP

9566PCX1 / 9566PC

6" SJS™ Paddle Switch Cut-Off/Angle Grinder

- Powerful 13.0 AMP motor delivers more output and 9,000 RPM
 - Constant speed control automatically applies additional power to the motor to maintain speed under load
 - Electronic current limiter helps protect the motor from overload
 - "Tool-less" grinding wheel guard for more convenient adjustments
 - Large no-lock-on paddle switch with lock-off for comfortable operation
- 9566PCX1 Includes:** 6" x 7/8" x 1/16" Super Thin Cut-off Wheel, Metal (724117-A), 6" Cut-Off Wheel Guard (165486-6), 6" x 1/4" x 7/8" INOX Grinding Wheel, 36 Grit (A-95978), 6" Tool-less Wheel Guard (1a) (135172-3), Lock Nut (224574-9), Lock Nut Wrench (782424-9), Inner Flange (224390-9), Side Handle (153489-2)
- 9566PC Includes:** 6" Cut-Off Wheel Guard (165486-6), Lock Nut (224574-9), Lock Nut Wrench (782424-9), Inner Flange (224390-9), Side Handle (153489-2), 6" x 7/8" x 1/16" Super Thin Cut-off Wheel, Metal (724117-A)

Wheel Diameter	6"
AMPS	13
No Load Speed	9,000 RPM
Spindle Thread	5/8" - 11 UNC
Lock-On Switch	No
Lock-Off Switch	Yes
Switch Type	Body grip/paddle
Overall Length	12-1/8"
Net Weight	5.5 lbs.
Shipping Weight	9566PCX1 (9.5 lbs.), 9566PC (7.5 lbs.)



13 AMP

9566CV

6" SJS™ Cut-Off/Angle Grinder

- Powerful 13.0 AMP motor delivers more output and variable (4,000 - 10,000) RPM
 - Variable speed control dial enables user to match the speed to the application
 - Constant speed control automatically applies additional power to the motor to maintain speed under load
 - Soft start suppresses start-up reaction for smooth start-ups and longer gear life
 - Electronic current limiter helps protect the motor from overload
 - SJS™ technology is a mechanical clutch system that helps prevent motor and gear damage
- 9566CV Includes:** 6" x 7/8" x 1/16" Super Thin Cut-off Wheel, Metal (724117-A), 6" Cut-Off Wheel Guard (122912-8), Lock Nut (224574-9), Lock Nut Wrench (782412-6), Inner Flange (224390-9), Side Handle (153489-2)

Wheel Diameter	6"
AMPS	13
No Load Speed (variable speed)	4,000 - 10,000 RPM
Spindle Thread	5/8" - 11 UNC
Lock-On Switch	Yes
Lock-Off Switch	No
Switch Type	Body grip/slide
Overall Length	11-3/4"
Net Weight	5.3 lbs.
Shipping Weight	7.7 lbs.



AC/DC

GA6020YX1

6" SJS™ Cut-Off/Angle Grinder

- Powerful 10.5 AMP motor delivers 10,000 RPM to handle the most demanding applications
- SJS™ technology is a mechanical clutch system that helps prevent motor and gear damage by allowing the drive shaft to slip
- Electric brake maximum productivity
- Rubberized soft grip handle provides increased operator comfort
- Tool-less wheel guard for quick and easy adjustments
- AC/DC switch for use with alternative power source

GA6020YX1 Includes: 6" x 7/8" x 1/16" Super Thin Cut-off Wheel, Metal (724117-A), 6" Cut-Off Wheel Guard (165744-0), 6" x 1/4" x 7/8" INOX Grinding Wheel, 36 Grit (A-95978), 6" Tool-less Wheel Guard (Tall) (123074-5), Lock Nut (193465-4), Lock Nut (224574-9), Lock Nut Wrench (782424-9), Inner Flange (224361-6), Inner Flange (224390-9), Side Handle (153504-2)

Wheel Diameter	6"
AMPS	10.5
No Load Speed	10,000 RPM
Spindle Thread	5/8" - 11 UNC
Lock-On Switch	No
Lock-Off Switch	Yes
Switch Type	Rear trigger switch
Overall Length	14"
Net Weight	6.7 lbs.
Shipping Weight	10 lbs.



AC/DC

GA6020

6" SJS™ Angle Grinder

- Powerful 10.5 AMP motor delivers 10,000 RPM
- SJS™ technology is a mechanical clutch system that helps prevent motor and gear damage by allowing the drive shaft to slip
- Electric brake for maximum productivity
- Rubberized soft grip handle provides increased operator comfort
- Tool-less wheel guard for quick and easy adjustments
- AC/DC switch for use with alternative power source

GA6020 Includes: 6" x 1/4" x 7/8" INOX Grinding Wheel, 36 Grit (A-95978), Lock Nut (193465-4), Lock Nut Wrench (782424-9), Inner Flange (224361-6), Side Handle (153504-2), 6" Tool-less Wheel Guard (Tall) (123074-5)

Wheel Diameter	6"
AMPS	10.5
No Load Speed	10,000 RPM
Spindle Thread	5/8" - 11 UNC
Lock-On Switch	No
Lock-Off Switch	No
Switch Type	Rear trigger switch
Overall Length	14"
Net Weight	6.7 lbs.
Shipping Weight	8.75 lbs.

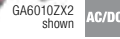

AC/DC

GA6010ZX2 / GA6010Z

6" Cut-Off/Angle Grinder

- Refined design at only 5.9 lbs. for reduced operator fatigue
- AC/DC switch for use with alternative power source
- Labyrinth construction seals and protects motor and bearings from contamination
- Externally accessible brushes for greater serviceability
- "Tool-less" grinding wheel guard for more convenient adjustments
- Includes both cutting/grinding wheels and guards

GA6010ZX2 Includes: 6" x 7/8" x 1/16" Thin Cut-off Wheel, Metal, 25/pk (724117-A-25), 6" Cut-Off Wheel Guard (165486-6), 6" x 1/4" x 7/8" INOX Grinding Wheel, 36 Grit (A-95978), 6" Tool-less Wheel Guard (Tall) (135172-3), Lock Nut (193465-4), Lock Nut Wrench (782424-9), Inner Flange (224361-6), Side Handle (153504-2)

GA6010Z Includes: 6" x 7/8" x 1/16" Super Thin Cut-off Wheel, Metal (724117-A), 6" Cut-Off Wheel Guard (165486-6), Lock Nut (224574-9), Lock Nut Wrench (782424-9), Inner Flange (224390-9), Side Handle (153504-2)

Wheel Diameter	6"
AMPS	10.5
No Load Speed	10,000 RPM
Spindle Thread	5/8" - 11 UNC
Lock-On Switch	No
Lock-Off Switch	No
Switch Type	Rear trigger switch
Overall Length	14"
Net Weight	5.9 lbs.
Shipping Weight:	GA6010ZX2 (9.5 lbs.), GA6010Z (8.8 lbs.)



GA7011C

7" Angle Grinder

- Powerful 15.0 AMP motor delivers 6,000 RPM
- Constant speed control automatically applies additional power to the motor to maintain speed under load
- Soft start suppresses start-up reaction for smooth start-ups and longer gear life
- Electronic current limiter helps protect the motor from overload
- "Tool-less" wheel guard for more convenient adjustments

GA7011C Includes: 7" x 7/8" x 1/4" Grinding Wheel, 24 Grit, General Purpose Metal (741413-3), 7" Tool-less Wheel Guard, GA7011C (122772-8), Lock Nut (193465-4), Lock Nut Wrench (782412-6), Inner Flange (224317-9), Side Handle (152539-0)

Wheel Diameter	7"
AMPS	15
No Load Speed	6,000 RPM
Spindle Thread	5/8" - 11 UNC
Lock-On Switch	Yes
Lock-Off Switch	Yes
Switch Type	Rear trigger handle
Overall Length	17-7/8"
Net Weight	7.5 lbs.
Shipping Weight	11.91 lbs.



AC/DC

GA7021

7" Angle Grinder

- Powerful 15 AMP motor delivers 6,600 RPM to handle the most demanding applications
- Rubberized soft grip handle provides increased operator comfort
- Rear trigger switch with lock-on for operator convenience
- Tool-less wheel guard for quick and easy adjustments
- Large rubber tool rest protects work piece from damage
- Three position adjustable side handle for operator convenience

GA7021 Includes: 7" x 7/8" x 1/4" Grinding Wheel, 24 Grit, General Purpose Metal (741413-B), 7" Tool-less Wheel Guard (122767-1), Lock Nut (193465-4), Lock Nut Wrench (782412-6), Inner Flange (224317-9), Side Handle (152539-0)

Wheel Diameter	7"
AMPS	15
No Load Speed	6,600 RPM
Spindle Thread	5/8" - 11 UNC
Lock-On Switch	Yes
Lock-Off Switch	No
Switch Type	Rear trigger handle
Overall Length	18-5/8"
Net Weight	12.2 lbs.
Shipping Weight	15.4 lbs.



AC/DC

GA7031Y

7" Angle Grinder

- Powerful 15.0 AMP motor delivers 8,500 RPM
- Spiral bevel gears for smoother rotations and a more efficient transfer of energy
- Three position vibration absorbing side handle provides increased comfort on the job
- Wire mesh intake covers are engineered to prevent debris from entering motor
- Rotatable back handle for increased comfort in various applications
- "Tool-less" wheel guard for more convenient adjustments

GA7031Y Includes: 7" Tool-less Wheel Guard (122767-1), Lock Nut (193465-4), Lock Nut Wrench (782412-6), Inner Flange (224317-9), Wire Mesh Intake Cover (194289-1), Side Handle (162264-5)

Wheel Diameter	7"
AMPS	15
No Load Speed	8,500 RPM
Spindle Thread	5/8" - 11 UNC
Lock-On Switch	No
Lock-Off Switch	Yes
Switch Type	Rear trigger switch
Overall Length	19-7/8"
Net Weight	13.5 lbs.
Shipping Weight	18 lbs.



AC/DC

GA7060

7" Angle Grinder

- Rear handle trigger switch with lock-on feature; lock-off feature requires two actions to start the grinder
- Redesigned motor with greater armature stability and larger commutator bars for 3 times longer life compared to previous model
- Zig-zag epoxy on both sides of the armature coil and a powder-coated field for added protection from dust and debris for longer motor life
- Labyrinth construction seals and protects the motor and bearings from dust and debris for longer tool life
- Large spindle lock button for easier wheel changes while wearing gloves
- Automatic brush cut-off protects motor from damage for longer tool life

GA7060 Includes: 7" Wheel Guard (122939-8), Lock Nut (224486-6), Lock Nut Wrench (782412-6), Inner Flange (224317-9), Side Handle (143486-6)

Wheel Diameter	7"
AMPS	15
No Load Speed	8,500 RPM
Spindle Thread	5/8" - 11 UNC
Lock-On Switch	No
Lock-Off Switch	Yes
Switch Type	Rear trigger handle
Overall Length	17-3/4"
Net Weight	11.7 lbs.
Shipping Weight	15.2 lbs.



GA7061

7" SJS™II Angle Grinder

- Rear handle trigger switch with lock-on feature; lock-off feature requires two actions to start the grinder
- Powerful 15.0 AMP motor delivers 8,500 RPM for optimum durability and performance
- Redesigned motor with greater armature stability and larger commutator bars for 3 times longer life compared to previous model
- SJS™II provides a leaf spring and cam gear drive mechanism that is engineered to reduce vibration for increased operator comfort during extended use
- Zig-zag epoxy on both sides of the armature coil and a powder-coated field for added protection from dust and debris for longer motor life
- Large spindle lock button for easier wheel changes while wearing gloves

GA7061 Includes: 7" Wheel Guard (122939-8), Lock Nut (224486-6), Lock Nut Wrench (782412-6), Inner Flange (224317-9), Side Handle (143486-6)

Wheel Diameter	7"
AMPS	15
No Load Speed	8,500 RPM
Spindle Thread	5/8" - 11 UNC
Lock-On Switch	No
Lock-Off Switch	Yes
Switch Type	Rear trigger handle
Overall Length	17-3/4"
Net Weight	11.7 lbs.
Shipping Weight	15.8 lbs.



AC/DC

GA7040S

7" Angle Grinder

- Powerful 15.0 AMP motor delivers 8,000 RPM
- Soft start suppresses start-up reaction for smooth start-ups and longer gear life
- Rotatable back handle for increased comfort in various applications
- Three position vibration absorbing side handle for increased comfort
- "Tool-less" wheel guard for more convenient adjustments

GA7040S Includes: 7" x 7/8" x 1/4" Grinding Wheel, 24 Grit, General Purpose Metal (741413-3), 7" Tool-less Wheel Guard (122767-1), Lock Nut (193465-4), Lock Nut Wrench (782412-6), Inner Flange (224317-9), Side Handle (162264-5)

Wheel Diameter	7"
AMPS	15
No Load Speed	8,000 RPM
Spindle Thread	5/8" - 11 UNC
Lock-On Switch	Yes
Lock-Off Switch	No
Switch Type	Rear trigger handle
Overall Length	20-1/8"
Net Weight	14.2 lbs.
Shipping Weight	17.3 lbs.



AC/DC

GA9031Y

9" Angle Grinder

- Powerful 15.0 AMP motor delivers 6,600 RPM
- Spiral bevel gears for smoother rotations and a more efficient transfer of energy
- Three position vibration absorbing side handle provides increased comfort on the job
- Wire mesh intake covers are engineered to prevent debris from entering motor
- Rotatable back handle for increased comfort in various applications
- "Tool-less" wheel guard for more convenient adjustments

GA9031Y Includes: 9" Tool-less Wheel Guard (122768-9), Lock Nut (193465-4), Lock Nut Wrench (782412-6), Inner Flange (224317-9), Wire Mesh Intake Cover (194289-1), Side Handle (162264-5)

Wheel Diameter	9"
AMPS	15
No Load Speed	6,600 RPM
Spindle Thread	5/8" - 11 UNC
Lock-On Switch	No
Lock-Off Switch	Yes
Switch Type	Rear trigger switch
Overall Length	19-7/8"
Net Weight	14 lbs.
Shipping Weight	18 lbs.



AC/DC

GA9040S

9" Angle Grinder

- Powerful 15.0 AMP motor delivers 6,000 RPM
- Soft start suppresses start-up reaction for smooth start-ups and longer gear life
- Rotatable back handle for increased comfort in various orientations
- "Tool-less" wheel guard for more convenient adjustments
- Three position vibration absorbing side handle for increased comfort

GA9040S Includes: 9" Grinding Wheel (741421-4), 9" Tool-less Wheel Guard (122768-9), Lock Nut (193465-4), Lock Nut Wrench (782412-6), Inner Flange (224317-9), Side Handle (162264-5)

Wheel Diameter	9"
AMPS	15
No Load Speed	6,000 RPM
Spindle Thread	5/8" - 11 UNC
Lock-On Switch	No
Lock-Off Switch	Yes
Switch Type	Rear trigger handle
Overall Length	20-1/8"
Net Weight	14.8 lbs.
Shipping Weight	19.9 lbs.



AC/DC

GA9060

9" Angle Grinder

- Rear handle trigger switch with lock-on feature; lock-off feature requires two actions to start the grinder
- Redesigned motor with greater armature stability and larger commutator bars for 3 times longer life compared to previous model
- Zig-zag epoxy on both sides of the armature coil and a powder-coated field for added protection from dust and debris for longer motor life
- Labyrinth construction seals and protects the motor and bearings from dust and debris for longer tool life
- Large spindle lock button for easier wheel changes while wearing gloves
- Automatic brush cut-off protects motor from damage for longer tool life

GA9060 Includes: 9" Wheel Guard (122938-0), Lock Nut (224486-6), Lock Nut Wrench (782412-6), Inner Flange (224317-9), Side Handle (143486-6)

Wheel Diameter	9"
AMPS	15
No Load Speed	6,600 RPM
Spindle Thread	5/8" - 11 UNC
Lock-On Switch	No
Lock-Off Switch	Yes
Switch Type	Rear trigger handle
Overall Length	17-3/4"
Net Weight	12.1 lbs.
Shipping Weight	15.4 lbs.



XAG12PT1 **XAG12Z1**

18V X2 LXT® (36V) Brushless 7" Cut-Off/Angle Grinder Kit

- Two 18V LXT® Lithium-Ion batteries deliver corded power without leaving the 18V LXT® battery platform
- Electric brake stops the grinding or cut-off wheel in 4.5 seconds or less for maximum productivity
- Active Feedback-sensing Technology (AFT™) turns the motor off if rotation of the wheel is suddenly forced to stop

XAG12PT1 Includes: 18V X2 LXT® (36V) Brushless 7" Cut-Off/Angle Grinder (XAG12Z1), (2) 18V LXT® Lithium-Ion 5.0Ah Battery (BL1850B), 18V LXT® Lithium-Ion Dual Port Charger (DC18RD), 7" Tool-less Wheel Guard (123542-8), 7" Cut-Off Wheel Guard (122914-4), 7" x 1/4" x 7/8" INOX Grinding Wheel, 36 Grit (A-96045), 7" x 1/16" x 7/8" INOX Thin Cut-Off Wheel, 60 Grit (B-12669), Side Handle (143486-6), 23" Contractor Tool Bag (831284-7), Lock Nut Wrench (782412-6)

XAG12Z1 Includes: Tool only, battery & charger not included 7" Tool-less Wheel Guard (123542-8), 7" Cut-Off Wheel Guard (122914-4), Side Handle (143486-6), 7" x 1/4" x 7/8" INOX Grinding Wheel, 36 Grit (A-96045), 7" x 1/16" x 7/8" INOX Thin Cut-Off Wheel, 60 Grit (B-12669), Lock Nut Wrench (782412-6)

Wheel Diameter	7"
Battery	2X 18V LXT® Lithium-Ion
No Load Speed	7,800 RPM
Spindle Thread	5/8" - 11 UNC
Lock-On Switch	No
Lock-Off Switch	Yes
Switch Type	Rear trigger handle
Electric Brake	Yes
Variable speed control dial	No
Automatic-start Wireless System (AWS™)	No
Overall Length	19-5/8"
Net Weight (with battery)	11.4 lbs.
Shipping Weight	29.768 lbs.



XAG13PT1 **XAG13Z1**

18V X2 LXT® (36V) Brushless 9" Cut-Off/Angle Grinder Kit

- Two 18V LXT® Lithium-Ion batteries deliver corded power without leaving the 18V LXT® battery platform
- Electric brake stops the grinding or cut-off wheel in 4.5 seconds or less for maximum productivity
- Active Feedback-sensing Technology (AFT™) turns the motor off if rotation of the wheel is suddenly forced to stop

XAG13PT1 Includes: 18V X2 LXT® (36V) Brushless 9" Cut-Off/Angle Grinder (XAG13Z1), (2) 18V LXT® Lithium-Ion 5.0Ah Battery (BL1850B), 18V LXT® Lithium-Ion Dual Port Charger (DC18RD), 9" Tool-less Wheel Guard (123543-6), 9" Cut-Off Wheel Guard (122913-6), 9" x 1/4" x 7/8" INOX Grinding Wheel, 36 Grit (A-96051), 9" x 0.075" x 7/8" INOX Thin Cut-Off Wheel, 60 Grit (B-12675), Side Handle (143486-6), 23" Contractor Tool Bag (831284-7), Lock Nut Wrench (782412-6)

XAG13Z1 Includes: Tool only, battery & charger not included 9" Tool-less Wheel Guard (123543-6), 9" Cut-Off Wheel Guard (122913-6), 9" x 1/4" x 7/8" INOX Grinding Wheel, 36 Grit (A-96051), 9" x 0.075" x 7/8" INOX Thin Cut-Off Wheel, 60 Grit (B-12675), Side Handle (143486-6), Lock Nut Wrench (782412-6)

Wheel Diameter	9"
Battery	2X 18V LXT® Lithium-Ion
No Load Speed	6,000 RPM
Spindle Thread	5/8" - 11 UNC
Lock-On Switch	No
Lock-Off Switch	Yes
Switch Type	Rear trigger handle
Electrical Brake	Yes
Variable speed control dial	No
Automatic-start Wireless System (AWS™)	No
Overall Length	19-5/8"
Net Weight (with battery)	13.01 lbs.
Shipping Weight	29.8 lbs.



XAG22ZU1

18V X2 LXT® (36V) Brushless 7" Angle Grinder, AWS™

- The BL™ Brushless Motor eliminates carbon brushes, enabling the BL™ Motor to run cooler and more efficiently for longer life; delivers 7,800 RPM
- Two 18V LXT® Lithium-Ion batteries deliver corded power without leaving the 18V LXT® battery platform (batteries not included)
- Active Feedback-sensing Technology (AFT™) turns the motor off if rotation of the wheel is suddenly forced to stop
- Electric brake stops the grinding or cut-off wheel in 4.5 seconds or less for maximum productivity
- Auto-start Wireless System (AWS™) utilizes Bluetooth® technology for wireless power-on/off communication between tool and dust extractor

XAG22ZU1 Includes: Tool only, battery & charger not included 7" Tool-less Wheel Guard (123542-8), 7" Cut-Off Wheel Guard (122914-4), 7" x 1/4" x 7/8" INOX Grinding Wheel, 36 Grit (A-96045), 7" x 1/16" x 7/8" INOX Thin Cut-Off Wheel, 60 Grit (B-12669), Side Handle (143486-6), Lock Nut Wrench (782412-6), Auto-Start Wireless Transmitter (198901-5)

Wheel Diameter	7"
No Load Speed	7,800 RPM
Spindle Thread	5/8" - 11 UNC
Lock-On Switch	No
Lock-Off Switch	Yes
Max. Cutting Depth	1-7/8"
Switch Type	Rear trigger handle
Electric Brake	Yes
Variable speed control dial	No
Automatic-start Wireless System (AWS™)	Yes (Transmitter Included)
Battery	2X 18V LXT® Lithium-Ion
Overall Length	19-5/8"
Net Weight (with battery)	11.4 lbs.
Shipping Weight	14.9 lbs.



XAG23ZU1

18V X2 LXT® (36V) Brushless 9" Angle Grinder, AWS™

- The BL™ Brushless Motor eliminates carbon brushes, enabling the BL™ Motor to run cooler and more efficiently for longer life; delivers 6,000 RPM
- Two 18V LXT® Lithium-Ion batteries deliver corded power without leaving the 18V LXT® battery platform (batteries not included)
- Active Feedback-sensing Technology (AFT™) turns the motor off if rotation of the wheel is suddenly forced to stop
- Electric brake stops the grinding or cut-off wheel in 4.5 seconds or less for maximum productivity
- Auto-start Wireless System (AWS™) utilizes Bluetooth® technology for wireless power-on/off communication between tool and dust extractor

XAG23ZU1 Includes: Tool only, battery & charger not included 9" Tool-less Wheel Guard (123543-6), 9" Cut-Off Wheel Guard (122913-6), 9" x 1/4" x 7/8" INOX Grinding Wheel, 36 Grit (A-96051), 9" x 0.075" x 7/8" INOX Thin Cut-Off Wheel, 60 Grit (B-12675), Side Handle (143486-6), Lock Nut Wrench (782412-6), Auto-Start Wireless Transmitter (198901-5)

Wheel Diameter	9"
Battery	2X 18V LXT® Lithium-Ion
No Load Speed	6,000 RPM
Spindle Thread	5/8" - 11 UNC
Lock-On Switch	No
Lock-Off Switch	Yes
Switch Type	Rear trigger handle
Electrical Brake	Yes
Variable speed control dial	No
Automatic-start Wireless System (AWS™)	Yes (Transmitter Included)
Overall Length	19-5/8"
Net Weight (with battery)	13.01 lbs.
Shipping Weight	19.11 lbs.



AC/DC

GA7001L

7" Angle Grinder

- Powerful 15.0 AMP motor delivers 6,000 RPM
- Enlarged all ball bearing construction for longer tool life
- Spiral bevel gears for smoother rotations and a more efficient transfer of energy
- Zig-zag varnish protects the armature coil from dust and debris for longer motor life
- AC/DC switch for use with alternative power source

GA7001L Includes: 7" x 7/8" x 1/4" Grinding Wheel, 24 Grit, General Purpose Metal (741413-3), 7" Wheel Guard (164477-4), Lock Nut (224512-1), Lock Nut Wrench (782412-6), Inner Flange (224111-9), Spindle Washer (261039-0), Side Handle (152492-0)

Wheel Diameter	7"
AMPS	15
No Load Speed	6,000 RPM
Spindle Thread	5/8" - 11 UNC
Lock-On Switch	Yes
Lock-Off Switch	No
Switch Type	Rear trigger switch
Overall Length	16-1/4"
Net Weight	12.6 lbs.
Shipping Weight	17.5 lbs.



AC/DC

GA7911

Angle Sander

- Powerful 15.0 AMP motor delivers 7,000 RPM
- Enlarged all ball bearing construction for longer tool life
- Spiral bevel gears for smoother rotations and a more efficient transfer of energy
- Zig-zag varnish protects the armature coil from dust and debris for longer motor life
- AC/DC switch for use with alternative power source
- Large tool rest bumper to help protect tool and surfaces from damage

GA7911 Includes: Spindle Washer (261039-0), Side Handle (152492-0)

Grinding Wheels	7" or 9"
AMPS	15
No Load Speed	7,000 RPM
Spindle Thread	5/8" - 11 UNC
Lock-On Switch	Yes
Lock-Off Switch	No
Overall Length	16-1/4"
Net Weight	12.2 lbs.
Shipping Weight	13 lbs.



GS5000

5" Straight Grinder

- "Tool-less" guard cap removal for more convenient wheel changes
- Rubberized gear housing and handle for operator comfort
- Spiral bevel gears for smoother rotations and a more efficient transfer of energy
- Externally accessible brushes for easier serviceability
- Zig-zag varnish protects the armature coil from dust and debris

GS5000 Includes: Wrench (783204-6), Wrench Holder (410047-0), (252105-4)

Max. Wheel Diameter	5"
AMPS	7
No Load Speed	5,600 RPM
Spindle Thread	5/8" x 24 UNC
Lock-On Switch	No
Lock-Off Switch	Yes
Overall Length	23-1/4"
Net Weight	11.1 lbs.
Shipping Weight	14.45 lbs.



GD0801C

1/4" SJS™ Paddle Switch Die Grinder

- Powerful 6.6 AMP motor delivers 7,000-29,000 RPM for faster material removal
- SJS™ technology is a mechanical clutch system that helps prevent motor and gear damage by allowing the drive shaft to slip
- Variable speed control dial enables user to match the speed to the application
- Soft start suppresses start-up reaction for smooth start-ups and longer gear life
- Electronic current limiter helps protect the motor from overload

GD0801C Includes: 1/4" Collet (192986-3), Spanner Wrench (781203-2), Side Handle (192985-5), Wrench #19 (781206-6)

Max. Wheel Diameter	1"
AMPS	6.6
Collet	1/4"
No Load Speed (variable speed)	7,000 - 29,000 RPM
Lock-On Switch	No
Lock-Off Switch	Yes
Overall Length	14-3/8"
Net Weight	4.2 lbs.
Shipping Weight	7 lbs.



GD0800C

1/4" SJS™ Die Grinder

- Powerful 6.6 AMP motor delivers 7,000-28,000 RPM
- SJS™ technology is a mechanical clutch system that helps prevent motor and gear damage by allowing the drive shaft to slip
- Variable speed control dial enables user to match the speed to the application
- Constant speed control automatically applies additional power to the motor to maintain speed under load
- Soft start suppresses start-up reaction for smooth start-ups and longer gear life
- **GD0800C Includes:** 1/4" Collet (192986-3), Spanner Wrench (781203-2), Side Handle (192985-5), Wrench #19 (781206-6)

Max. Wheel Diameter	1"
AMPS	6.6
Collet	1/4"
No Load Speed (variable speed)	7,000 - 28,000 RPM
Lock-On Switch	Yes
Lock-Off Switch	No
Overall Length	14-5/8"
Net Weight	3.7 lbs.
Shipping Weight	5.6 lbs.



AC/DC

GD0600

1/4" Paddle Switch Die Grinder

- Powerful 3.5 AMP motor delivers 25,000 RPM
- Lower noise at 73dB(A)
- Small diameter barrel grip for added comfort
- Directional air-flow vents channel the tool's air output away from the user's face
- Round-shaped collet nut is engineered to prevent damages/scratches to work surface
- AC/DC switch for use with alternative power source

GD0600 Includes: (2) Spanner Wrench (781039-9), (2) 1/4" Collet (763625-8)

Max. Wheel Diameter	1-1/2"
AMPS	3.5
Collet	1/4"
No Load Speed	25,000 RPM
Lock-On Switch	No
Lock-Off Switch	Yes
Overall Length	14-1/8"
Net Weight	3.7 lbs.
Shipping Weight	5.1 lbs.



AC/DC

GD0601

1/4" Die Grinder

- Powerful 3.5 AMP motor delivers 25,000 RPM
- Rubberized gear housing for increased operator comfort
- Small diameter barrel grip for added comfort
- Directional air-flow vents channel the tool's air output away from the user's face
- Round-shaped collet nut is engineered to prevent damages/scratches to workpiece
- Slide switch with lock-on for operator convenience

GD0601 Includes: 1/4" Collet (763625-8), (2) Spanner Wrench (781039-9)

Max. Wheel Diameter	1-1/2"
AMPS	3.5
Collet	1/4"
No Load Speed	25,000 RPM
Lock-On Switch	Yes
Lock-Off Switch	No
Overall Length	14-1/8"
Net Weight	3.7 lbs.
Shipping Weight	6.6 lbs.



GD0603

1/4" Compact Die Grinder

- Powerful 2.2 AMP motor delivers 28,000 RPM to handle unique applications
- Compact design with small 2-1/2" diameter barrel; weighs only 2.1 lbs. for added comfort
- Contoured neck grip provides a secondary hand position for increased maneuverability
- Round-shaped collet nut is designed to help prevent damage/scratches to workpiece
- Rocker switch with lock-on for operator convenience
- Metal hanging hook for added convenience

GD0603 Includes: Spanner Wrench (781003-0), 1/4" Cone Shaped Wheel Point (741616-9), 1/4" Round Wheel Point (741617-7), 1/4" Collet (763625-8)

Max. Wheel Diameter	3/4"
AMPS	2.2
Collet	1/4"
No Load Speed	28,000 RPM
Lock-On Switch	Yes
Lock-Off Switch	No
Overall Length	11-3/8"
Net Weight	2.1 lbs.
Shipping Weight	4 lbs.



XDG01T

XDG01Z



18V LXT® 1/4" Die Grinder Kit

- Compact barrel grip design and weighs only 4.4 lbs. for easy handling
- Slide switch with lock-on for operator convenience
- Vent slots designed to direct exhaust air away from the user
- L.E.D. light flashes red when it is time to recharge the battery
- Built-in L.E.D. protection circuit with over-torque control protects the motor
- Solid aluminum housing for added durability

XDG01T Includes: 18V LXT® 1/4" Die Grinder (XDG01Z), (2) 18V LXT® Lithium-Ion 5.0Ah Battery (BL1850B), 18V LXT® Lithium-Ion Rapid Optimum Charger (DC18RC), 1/4" Collet (763625-8), (2) Spanner Wrench (781039-9), Tool Bag (821016-X)

XDG01Z Includes: Tool only, battery & charger not included
1/4" Collet (763625-8), (2) Spanner Wrench (781039-9)

Max. Wheel Diameter	1-1/2"
Battery	18V LXT® Lithium-Ion
Collet	1/4"
No Load Speed	25,000 RPM
Lock-On Switch	Yes
Lock-Off Switch	No
Overall Length	15-3/4"
Net Weight (with battery)	4.4 lbs.
Shipping Weight	12.6 lbs.



XDG02Z

18V LXT® 1/4" Compact Die Grinder

- Makita-built 4-pole motor delivers 26,000 revolutions per minute for faster grinding
- Short neck design is only 12-1/8" long with battery (not included) for increased maneuverability
- Compact barrel grip design with rubberized soft grip allows for easy grinding in various orientations
- Vent slots designed to direct exhaust air away from the user
- Built-in alert light provides overload motor protection warning and low battery recharge warning for operator convenience
- Anti-restart protection designed to prevent motor start up when battery is inserted with switch locked on

XDG02Z Includes: Tool only, battery & charger not included
1/4" Collet (763673-7), Collet Nut (763668-0), Spanner Wrench (781039-9)

Max. Wheel Diameter	1-1/2"
Battery	18V LXT® Lithium-Ion
Collet	1/4"
No Load Speed	26,000 RPM
Lock-On Switch	Yes
Lock-Off Switch	No
Overall Length	12-1/8"
Net Weight (with battery)	3.8 lbs.
Shipping Weight	3.31 lbs.



GV5010

5" Disc Sander

- Powerful 3.9 AMP motor delivers 5,000 RPM
- Precision balance with rubberized soft grip handle for greater comfort
- Rubberized mold over motor housing for added precision and control in a variety of applications
- Two position adjustable side handle for operator convenience
- Lock-on button for continuous operation

GV5010 Includes: 5" Abrasive Disc, 80 Grit, 5/pk (742109-9), 5" Plastic Backing Pad (743025-8), Side Handle (152491-2), Hex Wrench (783203-8)

Sanding Disc	5"
No Load Speed	5,000 RPM
AMPS	3.9
Overall Length	7-1/8"
Net Weight	2.6 lbs.
Shipping Weight	2.6 lbs.



GV7000C

7" Disc Sander

- Advanced electronics include soft start and electronic speed control
- Variable speed (2,500 - 4,700 RPM)
- Trigger lock-on button for operator convenience
- Motor-over-pad design for better balance
- Externally accessible carbon brushes for efficient maintenance
- **GV7000C Includes:** 7" Abrasive Disc, 80 Grit, 5/pk (742071-A-5), 7" Rubber Backing Pad (192978-2), Lock Nut (193048-0), Spanner Wrench (781008-0), Lock Nut Wrench (782412-6), Side Handle (152491-2)

Sanding Disc	7"
Wool Bonnet	7"
No Load Speed (variable speed)	2,500 - 4,700 RPM
Spindle Thread	5/8" - 11 UNC
AMPS	7.9
Overall Length	8-1/4"
Net Weight	4.6 lbs.
Shipping Weight	6.62 lbs.



JS3201

10 Gauge Shear

- Powerful 6.2 AMP motor; 1,600 SPM for the most demanding applications
- Engineered to cut without the material loss in kerf
- Less noise at 81 dB(A) for continuous operation
- Tight 2" cutting radius for greater versatility
- Lock-on switch for continuous operation
- Built-in thickness gauge for convenience

JS3201 Includes: Hex Wrench (783202-0), Shear Blade Set, JS3201 (792287-5), Thickness Gauge (123456)

Capacity (aluminum, ga.)	9 ga.
Capacity (mild steel, ga.)	10 ga.
Capacity (stainless, ga.)	13 ga.
Strokes Per Minute	1,600 SPM
AMPS	6.2
Overall Length	8-3/8"
Net Weight	7.4 lbs.
Shipping Weight	8.8 lbs.



JS1602

16 Gauge Shear

- Powerful 3.3 AMP motor delivers 4,000 SPM for the most demanding applications
- Small circumference barrel grip (only 2-1/4") for added comfort
- Refined design at only 3.4 lbs. for increased control
- Lock-on slide switch for continuous operation
- Built-in thickness gauge for added convenience
- Large easily replaceable blades with 8 cutting edge each

JS1602 Includes: Hex Wrench (783201-2), Shear Blade Set (191383-0)

Capacity (aluminum, ga.)	13 ga.
Capacity (mild steel, ga.)	16 ga.
Capacity (stainless, ga.)	18 ga.
Strokes Per Minute	4,000 SPM
AMPS	3.3
Overall Length	12-1/2"
Net Weight	3.4 lbs.
Shipping Weight	4.9 lbs.



JS1300

18 Gauge Straight Shear

- Cuts up to 18 gauge mild steel, 20 gauge stainless and 13 gauge aluminum
- Pistol grip design for comfort and convenience
- Shear head attachment rotates 360°
- Large variable speed trigger switch for controlled cutting speed
- Retractable belt clip allows operation in tight areas
- Lock-on button for continuous operation

JS1300 Includes: Shear Blade, Right (725092-5), Shear Blade, Left (725093-3), Shear Blade, Center (725094-1), Shear Head Assembly (125112-9), Hex Wrench (783215-1)

Capacity (aluminum, ga.)	13 ga.
Capacity (mild steel, ga.)	18 ga.
Capacity (stainless, ga.)	20 ga.
Strokes Per Minute (variable speed)	0 - 2,500 SPM
AMPS	6.5
Overall Length	11-7/8"
Net Weight	3.9 lbs.
Shipping Weight	5.28 lbs.



XSJ01T

XSJ01Z



18V LXT® 18 Gauge Straight Shear Kit

- Makita-built 4-pole motor delivers 3,000 strokes per minute for faster cutting
- Cuts up to 18 gauge mild steel and 20 gauge stainless steel
- Compact and ergonomic design at only 13-3/4" long
- Weighs only 5.3 lbs. with battery for reduced operator fatigue
- Reversible belt-clip attaches to either side of the tool
- Rubberized soft grip handle provides increased comfort on the job

XSJ01T Includes: 18V LXT® 18 Gauge Straight Shear (XSJ01Z), (2) 18V LXT® Lithium-Ion 5.0Ah Battery (BL1850B), 18V LXT® Lithium-Ion Rapid Optimum Charger (DC18RC), Tool Bag

XSJ01Z Includes: Tool only, battery & charger not included

Capacity (mild steel, ga.)	18 ga.
Capacity (stainless, ga.)	20 ga.
Strokes Per Minute	3,000 SPM
Battery	18V LXT® Lithium-Ion
360° Rotating Head	Yes
Overall Length	13-3/4"
Net Weight (with battery)	5.3 lbs.
Shipping Weight	13.6 lbs.



LXT

XSJ02Z

18V LXT® 16 Gauge Compact Straight Shear

- Cuts up to 16 ga. mild steel, 18 ga. stainless steel and easily cuts through 22 ga. spiral duct seams
- Makita-built 4-pole motor delivers 4,300 strokes per minute for faster cutting
- Compact barrel grip design with rubberized soft grip enables one-handed operation in various orientations
- High performance double blade design minimizes material distortion and produces clean cuts with minimal burrs
- Radius cutting capability allows for easy turns and circular cutting applications
- Built-in alert light provides overload motor protection warning and low battery recharge warning for operator convenience

XSJ02Z Includes: Tool only, battery & charger not included
Center Blade (792534-4), Side Blade Set (792533-6), Hex Wrench (783201-2), (762013-6)

Capacity (mild steel, ga.)	16 ga.
Capacity (stainless, ga.)	18 ga.
Strokes Per Minute	4,300 SPM
Battery	18V LXT® Lithium-Ion
360° Rotating Head	No
Overall Length	14-1/4"
Net Weight	4.4 lbs.
Power Type	Cordless
Shipping Weight	3.97 lbs.



JN3201

10 Gauge Nibbler

- Less noise at 81 dB(A) for continuous operation
- Well balanced with a rubberized soft grip handle for greater comfort
- Built-in thickness gauge for added convenience
- Refined design at only 7.4 lbs.
- Lock-on switch for continuous operation
- Highly visible line-of-sight for precise pattern following

JN3201 Includes: Punch (792728-1), Die (792292-2), Hex Wrench (783201-2), Spanner Wrench (781019-5)

Capacity (aluminum, ga.)	10 ga.
Capacity (mild steel, ga.)	10 ga.
Capacity (stainless, ga.)	13 ga.
Cutting Radius (inner edge)	4-3/4"
Cutting Radius (outer edge)	5-1/16"
Strokes Per Minute	1,300 SPM
AMPS	6.2
Overall Length	8-1/2"
Net Weight	7.5 lbs.
Shipping Weight	8.8 lbs.



JN1601

16 Gauge Nibbler

- For clean and precise work in keystone plate, deck plate and other sheet materials
- Slim and ergonomic body design for easy gripping
- Die rotates 360°; large 1/4" stroke
- Extremely light (weighs only 3.6 lbs.) for easier handling
- Lock-on sliding switch for continuous use
- Built-in thickness gauge for convenience

JN1601 Includes: Spanner Wrench (781028-4), Blade Wrench (783208-8)

Capacity (aluminum, ga.)	10 ga.
Capacity (mild steel, ga.)	16 ga.
Capacity (stainless, ga.)	18 ga.
Cutting Radius (inner edge)	1-3/4"
Cutting Radius (outer edge)	2"
Strokes Per Minute	2,200 SPM
AMPS	5
Overall Length	10-1/4"
Net Weight	3.6 lbs.
Shipping Weight	5.28 lbs.



LXT

XNJ01T

18V LXT® 16 Gauge Nibbler Kit

- Makita-built motor delivers 1,900 SPM for faster and smooth cutting
- Ideal for cutting roofing sheet metal at thicknesses up to 16 gauge
- Die holder rotates 360° to meet demands of cutting direction
- Convenient chip disposal is below cutting material to minimize damage to cutting surface
- Cutting radius: inner edge 1-3/4"; outer edge 2"
- Battery capacity warning system turns light solid red and automatically stops motor to notify user that battery needs to be replaced

XNJ01T Includes: 18V LXT® 16 Gauge Nibbler (XNJ01Z), (2) 18V LXT® Lithium-Ion 5.0Ah Battery (BL1850B), 18V LXT® Lithium-Ion Rapid Optimum Charger (DC18RC), Punch (A-83951), Spanner Wrench (781028-4), Tool Bag

XNJ01Z Includes: Tool only, battery & charger not included
Punch (A-83951), Spanner Wrench (781028-4)

Capacity (aluminum, ga.)	12 ga.
Capacity (mild steel, ga.)	16 ga.
Capacity (stainless, ga.)	18 ga.
Cutting Radius (inner edge)	1-3/4"
Cutting Radius (outer edge)	2"
Strokes Per Minute (variable speed)	0 - 1,900 SPM
Battery	18V LXT® Lithium-Ion
Overall Length	12-3/8"
Net Weight (with battery)	4.8 lbs.
Shipping Weight	12.57 lbs.



JS8000

Fiber Cement Shear

- Single-piece shear head is machined from precisely milled aluminum to ensure blades cut straight
- Solid steel blades cut clean, straight lines with a maximum cutting capacity up to 5/16"
- Protected drive spindle withstands heavy torque loads
- Cast aluminum gear housing for less weight and increased durability
- Retractable tool hook allows user to work in tight spaces
- Cuts fiber cement quickly while producing less dust

JS8000 Includes: Shear Blade, Center (725129-8), (2) Shear Blade Set (725130-3), Hex Wrench (783221-6), Tool Case (824780-2)

Capacity	5/16"
Strokes Per Minute (variable speed)	0 - 2,500 SPM
AMPS	6.5
Overall Length	13-5/8"
Net Weight	4.8 lbs.
Shipping Weight	8.5 lbs.



2107FZ shown

2107FZ / 2107FZK

Portable Band Saw

- Powerful 6.5 AMP motor with large (4-3/4" x 4-3/4") cutting capacity for demanding applications
- Variable speed control dial (200-350 ft./min.) enables user to match the speed to the application
- Adjustable front handle for greater maneuverability and comfort
- Built-in, high-output fluorescent light illuminates the cutting area for increased visibility
- Dual ball bearing blade guides assist in blade alignment for greater cutting accuracy
- Durable aluminum frame and protective rubber guard bumpers for increased durability

2107FZ Includes: 44-7/8" 18TPI Band Saw Blade (792556-A), Hex Wrench (783202-0), Wrench Holder (410048-8)

2107FZK Includes: 44-7/8" 18TPI Band Saw Blade (792556-A), Hex Wrench (783202-0), Wrench Holder (410048-8), Tool Case (824728-4)

Max. Cutting Capacity (round workpiece)	4-3/4"
Max. Cutting Capacity (rectangular workpiece)	4-3/4" x 4-3/4"
No Load Speed (ft./min., var. speed)	200 - 350 ft./min.
Blade Length	44-7/8"
AMPS	6.5
Overall Length	20-5/8"
Net Weight	13.1 lbs.
Shipping Weight:	2107FZ (17.5 lbs.), 2107FZK (23 lbs.)



LXT

XBP02TX

18V LXT® Portable Band Saw Kit

- 4-3/4" cutting capacity accepts a 44-7/8" blade and is ideal for cutting multiple metal materials
- Makita-built motor delivers faster cutting with variable speed 275-530 ft./min.
- Trigger switch with lock-off feature requires two actions to power on the band saw
- Conveniently located variable speed control dial enables user to match the speed to the application
- Protection circuit with built-in alert light provides over-torque motor protection warning
- Built-in L.E.D. light illuminates the work area for increased visibility

XBP02TX Includes: 18V LXT® Portable Band Saw (XBP02Z), (2) 18V LXT® Lithium-Ion 5.0Ah Battery (BL1850B), 18V LXT® Lithium-Ion Rapid Optimum Charger (DC18RC), 44-7/8" 18TPI Band Saw Blade (792556-A), Tool Bag (831263-5)

XBP02Z Includes: Tool only, battery & charger not included
44-7/8" 18TPI Band Saw Blade (792556-A)

Max. Cutting Capacity (round workpiece)	4-3/4"
Max. Cutting Capacity (rectangular workpiece)	4-3/4" x 4-3/4"
No Load Speed (ft./min., var. speed)	275 - 530 ft./min.
Blade Length	44-7/8"
Battery	18V LXT® Lithium-Ion
Overall Length	20-5/8"
Net Weight (with battery)	14.3 lbs.
Shipping Weight	28.1 lbs.



LXT COMPACT

XBP03T

18V LXT® Compact Band Saw Kit

- 2-1/2" cutting capacity is ideal for cutting conduit, Unistrut®, copper pipe, threaded rod, angle iron and channel
- Makita-built motor delivers 630 ft./min. blade speed for faster cutting
- Wheel cover encloses the blade outside the cutting area making the saw suitable for one-handed operation
- Aluminum blade housing for increased durability
- Exterior blade adjustment provides more accurate blade tracking for increased cutting performance
- Compact design at 18-3/4" long; weighs only 9 lbs. (with battery) for convenient operation

XBP03T Includes: (2) 18V LXT® Lithium-Ion 5.0Ah Battery (BL1850B), 18V LXT® Lithium-Ion Rapid Optimum Charger (DC18RC), Band Saw Blade, Hex Wrench

XBP03Z Includes: Tool only, battery & charger not included
Band Saw Blade

Max. Cutting Capacity (round workpiece)	2-1/2"
Max. Cutting Capacity (rectangular workpiece)	2-1/2" x 2-1/2"
No Load Speed (ft./min.)	630 ft./min.
Blade Length	32-7/8"
Battery	18V LXT® Lithium-Ion
Overall Length	18-3/4"
Net Weight (with battery)	9 lbs.
Built-in light	Yes

CORDLESS 14" CUT-OFF SAW



LW1400

14" Cut-Off Saw with Tool-Less Wheel Change

- Powerful 15 AMP motor delivers 3,800 RPM for superior performance and durability
- "Tool-less" flange removal for quick and easy blade and wheel changes
- Extra-large spark guard captures and deflects debris away from the surrounding area
- Large cutting capacity; cuts up to 5" round and 4" x 7-5/8" rectangular
- "Tool-less" fence & vice adjustment for quick and easy operation
- Locking pin secures cutting head in down position for easy transport and storage

LW1400 Includes: 14" x 1" x 7/64" Abrasive Cut-Off Wheel (A-93859-1)

AMPS	15
Blade Diameter	14"
No Load Speed	3,800 RPM
Max. Cutting Capacity (at 90°)	5"
Arbor	1"
Tool-less blade change	Yes
Tool-less fence adjustment	Yes
Lock-Off Switch	Yes
Electric Brake	No
Overall Length	20-7/8"
Net Weight	37.9 lbs.
Shipping Weight	50.4 lbs.



LW1401 shown

LW1401 / LW1401X / LW1401X2

14" Cut-Off Saw

- Powerful 15 AMP motor delivers 3,800 RPM for superior performance and durability
- Adjustable spark guard designed to divert sparks
- Two-stage lock-off power button for operator convenience
- Fence adjustment up to 45° for angle cuts; adjusts to 3 locations for various material sizes
- Weights only 37 lbs. for increased job site portability

LW1401 Includes: 14" x 1" x 7/64" Abrasive Cut-Off Wheel (A-93859-1), Socket Wrench (782210-8)

LW1401X Includes: Socket Wrench (782210-8), 14" x 7/64" x 1" Abrasive Cut-Off Wheel, 5/pk (A-93859-5)

LW1401X2 Includes: 14" x 1" x 7/64" Abrasive Cut-Off Wheel (A-93859-1), Socket Wrench (782210-8), 4-1/2" Paddle Switch Angle Grinder (9557PB)

AMPS	15
Blade Diameter	14"
No Load Speed	3,800 RPM
Max. Cutting Capacity (at 90°)	5"
Arbor	1"
Tool-less blade change	No
Tool-less fence adjustment	No
Lock-Off Switch	Yes
Electric Brake	No
Overall Length	19-3/4"
Net Weight	37 lbs.
Shipping Weight	LW1401 (50.4 lbs.), LW1401X (51.7 lbs.), LW1401X2 (51.5 lbs.)



AC/DC

2414DB

14" Cut-Off Saw, w/ AC/DC Switch

- Cuts 4-1/2" Round Stock at 45° and 90°
- Lock-off button for user convenience
- Fence adjusts 45° right and left; 3 locations for various material sizes
- Quick release vise for secure material retention and faster, repeated cut-offs
- Spark diversion guard
- Adjustable depth stop for precise, repeatable cutting depth

2414DB Includes: Socket Wrench (782210-8), AC/DC Switch (411478-6), 14" x 1" x 7/64" Abrasive Cut-Off Wheel (A-93859-1)

AMPS	15
Blade Diameter	14"
No Load Speed	3,800 RPM
Max. Cutting Capacity (at 90°)	4-1/2"
Arbor	1"
Tool-less blade change	No
Tool-less fence adjustment	No
Lock-Off Switch	No
Electric Brake	No
Overall Length	19-3/4"
Net Weight	37.1 lbs.
Shipping Weight	42 lbs.



LC1230

12" Metal Cutting Saw

- Carbide tipped blade lasts 50X longer than abrasive wheels; cuts clean, accurate and virtually burr free
- Powerful 15.0 AMP motor for the most demanding applications
- 4x faster cutting in light pipe, angle iron, tubing, conduit and channel than abrasive cut-off saws
- Quick release vise for secure stock retention and faster repeated cut-offs
- Lock-off button for user convenience
- Quick release support fence adjusts 0 - 45° for miter cutting

LC1230 Includes: 12" (60T) Carbide-Tipped Metal Cutting Blade Metal (A-90532), Socket Wrench (782210-8), Safety Goggles (191686-2)

AMPS	15
Blade Diameter	12"
No Load Speed	1,300 RPM
Max. Cutting Capacity (at 90°)	4-1/2"
Max. Cutting Capacity (at 45°)	3-1/2"
Arbor	1"
No Tool Blade Change	No
Overall Length	20-1/4"
Net Weight	42.5 lbs.
Shipping Weight	50.1 lbs.



CA5000X

4-5/8" Aluminum Groove Cutter

- 12 AMP motor for optimum performance in aluminum composite materials
- Variable speed control dial (2,200 - 6,400 RPM) enables user to match the speed to the application
- Built-in depth adjustment dial allows multiple cutting stops at 3 mm, 4 mm and 6 mm
- Electronic controller provides constant speed control which automatically applies additional power to the motor to maintain speed under load
- Mechanical brake for increased productivity
- Smooth and convenient plunge release lever for operator comfort

CA5000X Includes: 4-5/8" (3 mm) Aluminum Grooving C.T. Saw Blade, 90° (A-96132), Hex Wrench (783022-2)

AMPS	12
Blade Diameter	4-5/8"
No Load Speed (variable speed)	2,200 - 6,400 RPM
Max. Cutting Depth	7/16"
Arbor	13/16"
Overall Length	13-5/8"
Net Weight	11.3 lbs.
Shipping Weight	14.75 lbs.



4131

7-1/4" Metal Cutting Saw

- Powerful 13 AMP motor cuts through various types of metal
- Heavy duty blade cover provides increased chip protection
- Virtually spark-free cuts
- CERMET tipped blade leaves burr-free cuts that are cool to the touch
- "Tool-less" blade cover helps prevent heat build-up
- Large cutting capacity for single pass cutting

4131 Includes: 7-1/4" 36T CERMET Tipped Saw Blade, Ferrous Metal (A-93815), Hex Wrench (783203-8), Wrench Holder (410047-0), Safety Goggles (191686-2)

AMPS	13
Blade Diameter	7-1/4"
No Load Speed	3,500 RPM
Max. Cutting Depth	2-1/2"
Arbor	5/8"
Overall Length	14-1/8"
Net Weight	10.6 lbs.
Shipping Weight	14.9 lbs.

TECHNOLOGY

Two 18V LXT® Lithium-Ion batteries deliver the power and run time for corded demands

POWER

BL™ Brushless Motor eliminates carbon brushes, enabling the Motor to run more efficiently



NEW XWL01PT

18V X2 LXT® (36V) Brushless 14" Cut-Off Saw Kit

- Two 18V LXT® Lithium-Ion batteries deliver the power and run time for corded demands without leaving the 18V LXT® platform
- The BL™ Brushless Motor eliminates carbon brushes, enabling the BL™ Motor to run cooler and more efficiently for longer life; delivers 3,800 RPM
- Large spark guard captures and deflects debris away from the surrounding area
- Electric brake allows adjustments to be completed faster for maximum productivity
- "Tool-less" flange removal for quick and easy wheel changes
- Integrated overload status indicator alerts of excessive battery power draw during heavy loads which may reduce run time performance
- Two-stage lock-off power button requires two actions to start the cut-off saw
- Soft start suppresses start-up reaction for smooth start-ups and longer gear life

XWL01PT Includes: 18V X2 LXT® (36V) Brushless 14" Cut-Off Saw (XWL01Z), (2) 18V LXT® Lithium-Ion 5.0Ah Battery (BL1850B), 18V LXT® Lithium-Ion Dual Port Charger (DC18RD), 14" x 1" x 3/32" Abrasive Cut-Off Wheel (B-64705-1)

XWL01Z Includes: Tool only, battery & charger not included 14" x 1" x 3/32" Abrasive Cut-Off Wheel (B-64705-1)

Battery	2X 18V LXT® Lithium-Ion
Blade Diameter	14"
No Load Speed	3,800 RPM
Max. Cutting Capacity (at 90°)	5"
Arbor	1"
Tool-less blade change	Yes
Tool-less fence adjustment	Yes
Lock-Off Switch	Yes
Electric Brake	Yes
Overall Length	21-1/8"
Net Weight	35.9 lbs.
Shipping Weight	49.46 lbs.

FASTER METAL CUTTING

CUTS A WIDE RANGE OF METAL MATERIAL UP TO 2-1/4"

LXT BRUSHLESS

CAPACITY

Up to 2-1/4" cutting depth in metals including thread rod, strut, conduit, pipe, tubing and more

POWER

Brushless Motor eliminates carbon brushes, enabling the BL™ Motor to run cooler and more efficiently



NEW XSC04T

18V LXT® BL™ 5-7/8" Metal Cutting Saw Kit, w/ Electric Brake and Chip Collector

- Powerful BL™ Brushless Motor Delivers up to 125 cuts per charge in 1" SCH 40 Pipe using an 18V LXT® 5.0Ah Battery
- Up to 2-1/4" cutting depth in various metal materials including thread rod, channel strut, conduit, pipe, square tubing, sheet metal and more
- The BL™ Brushless Motor eliminates carbon brushes, enabling the BL™ Motor to run cooler and more efficiently for longer life, delivers 4,200 RPM
- Transparent chip collector box captures debris produced while cutting and provides needed visibility in determining need for disposal
- Automatic Speed Change™ technology adjusts cutting speed and torque during cut for optimum performance
- Electric brake allows the tool to be repositioned faster for maximum productivity
- Trigger switch with two stage lock-off requires two actions to power the saw
- Battery side-loads providing a more compact design at only 10-1/2" long for easier use in constrained spaces

XSC04T Includes: 18V LXT® BL™ 5-7/8" Metal Cutting Saw, with Electric Brake and Chip Collector (XSC04Z), (2) 18V LXT® Lithium-Ion 5.0Ah Battery (BL1850B), 18V LXT® Lithium-Ion Rapid Optimum Charger (DC18RC), 5-7/8" 32T C.T. Saw Blade (A-96095), Hex Wrench (783203-8), Tool Bag (831271-6), Eye Goggles

XSC04Z Includes: Tool only, battery & charger not included 5-7/8" 32T C.T. Saw Blade (A-96095), Hex Wrench (783203-8), Eye Goggles

Blade Diameter	5-7/8"
Arbor	5/8"
Max. Cutting Depth	2-1/4"
No Load Speed	4,200 RPM
Electric Brake	Yes
Dust Collection	Yes
Battery	18V LXT® Lithium-Ion
Overall Length	10-1/2"
Net Weight (with battery)	6.8 lbs.

XSC04Z



LXT BRUSHLESS

XSC02T

XSC02Z

18V LXT® Brushless 5-7/8" Metal Cutting Saw Kit

- Automatic Speed Change™ technology adjusts cutting speed and torque during cut for optimum performance
- Large cutting capacity (2-1/4" at 90°) allows for 2" conduit to be cut in a single pass
- BL™ Motor delivers 3,900 RPM for faster cutting
- The BL™ Brushless Motor eliminates carbon brushes, enabling the BL™ Motor to run cooler and more efficiently for longer life
- Cuts a wide range of metals including Unistrut®, all thread, channel, conduit, pipe, sheet metal, square tubing, steel and more

XSC02T Includes: 18V LXT® Brushless 5-7/8" Metal Cutting Saw (XSC02Z), (2) 18V LXT® Lithium-Ion 5.0Ah Battery (BL1850B), 18V LXT® Lithium-Ion Rapid Optimum Charger (DC18RC), 5-7/8" 32T C.T. Saw Blade (A-96095), Tool Bag (831271-6)

XSC02Z Includes: Tool only, battery & charger not included 5-7/8" 32T C.T. Saw Blade (A-96095)

Blade Diameter	5-7/8"
Arbor	5/8"
Max. Cutting Depth	2-1/4"
No Load Speed	3,900 RPM
Battery	18V LXT® Lithium-Ion
Overall Length	13-1/8"
Net Weight (with battery)	6.4 lbs.
Shipping Weight	15.2 lbs.



LXT

NEW XSC03T

XSC03Z

18V LXT® 5-3/8" Metal Cutting Saw Kit, with Electric Brake and Chip Collector

- Up to 2" cutting depth in various metal materials including thread rod, channel strut, conduit, pipe, square tubing, sheet metal and more
- Makita-built motor delivers 3,600 RPM for faster cutting using an 18V LXT® Lithium-Ion battery
- Chip collector box captures debris produced while cutting
- Transparent chip container provides needed visibility in determining when the debris need to be emptied
- Trigger switch with two stage lock-off requires two actions to power the saw

XSC03T Includes: 18V LXT® 5-3/8" Metal Cutting Saw, with Electric Brake and Chip Collector (XSC03Z), (2) 18V LXT® Lithium-Ion 5.0Ah Battery (BL1850B), 18V LXT® Lithium-Ion Rapid Optimum Charger (DC18RC), 5-3/8" 30T C.T. Saw Blade (A-95037), Hex Wrench (783203-8), Tool Bag (831271-6), Eye Goggles

XSC03Z Includes: Tool only, battery & charger not included 5-3/8" 30T C.T. Saw Blade (A-95037), Hex Wrench (783203-8), Eye Goggles

Blade Diameter	5-3/8"
Arbor	5/8"
Max. Cutting Depth	2"
No Load Speed	3,600 RPM
Electric Brake	Yes
Dust Collection	Yes
Battery	18V LXT® Lithium-Ion
Overall Length	13-3/4"
Net Weight (with battery)	6 lbs.



LXT

XSC01T

XSC01Z

18V LXT® 5-3/8" Metal Cutting Saw Kit

- Makita-built motor delivers 3,600 RPM for faster cutting
- Cuts a wide range of metals including Unistrut®, all thread, channel, conduit, pipe, sheet metal, square tubing, steel and more
- Compact and ergonomic design at 13-3/4" long
- Weighs only 5.7 lbs. with battery for reduced operator fatigue
- Rubberized soft grip handle provides increased comfort on the job
- Built-in L.E.D. light illuminates the work area

XSC01T Includes: 18V LXT® 5-3/8" Metal Cutting Saw (XSC01Z), (2) 18V LXT® Lithium-Ion 5.0Ah Battery (BL1850B), 18V LXT® Lithium-Ion Rapid Optimum Charger (DC18RC), 5-3/8" 30T C.T. Saw Blade (A-95037), Tool Case

XSC01Z Includes: Tool only, battery & charger not included 5-3/8" 30T C.T. Saw Blade (A-95037)

Blade Diameter	5-3/8"
Arbor	5/8"
Max. Cutting Depth	2"
No Load Speed	3,600 RPM
Battery	18V LXT® Lithium-Ion
Overall Length	13-3/4"
Net Weight (with battery)	5.7 lbs.
Shipping Weight	16 lbs.



LXT BRUSHLESS AUTOMATIC SPEED CHANGE

XCS02T1

XCS02ZK

18V LXT® Brushless Steel Rod Flush-Cutter Kit

- BL™ Brushless Motor delivers 2,200 RPM for faster spark free cutting
- Automatic Speed Change™ technology adjusts cutting speed and torque during cut for optimum performance
- Spark free cold cutting of rebar, threaded-rod and other metal objects with a carbide-tipped cutting blade
- The electronically-controlled BL™ Brushless Motor efficiently uses energy to match torque and RPM to the changing demands of the application
- Chip collecting bag captures metal cut-offs (optional accessory)

XCS02T1 Includes: 18V LXT® Brushless Steel Rod Flush-Cutter (XCS02ZK), 18V LXT® Lithium-Ion 5.0Ah Battery (BL1850B), 18V LXT® Lithium-Ion Rapid Optimum Charger (DC18RC), 4-5/16" 24T Carbide-Tipped Blade (SC19002890), Chip Collector (SC08106610), Side Handle, Tool Case, Long Hex Wrench M5

XCS02ZK Includes: Tool only, battery & charger not included 4-5/16" 24T Carbide-Tipped Blade (SC19002890), Chip Collector (SC08106610), Hex Wrench (M5) (SC08200100), Side Handle, Tool Case,

Blade Diameter	4-5/16"
Cutting Capacity (thickness)	1"
No Load Speed	2,200 RPM
Lock On Switch	Yes
Lock-Off Switch	No
Switch Type	Slide
Battery	18V LXT® Lithium-Ion
Overall Length	18-17/32"
Net Weight (with battery)	8.8 lbs.
Shipping Weight	23.45 lbs.



LXT BRUSHLESS

NEW XCS03Z

18V LXT® Brushless Threaded Rod Cutter

- Spark-free cutting for clean, burr-free cuts allowing for easy threading
- Performs up to 1,300 cuts of 3/8" mild steel threaded rod and 1,200 cuts of 3/8" stainless steel threaded rod with one 18V LXT 5.0Ah Battery
- Ideal for overhead cutting of installed threaded rod including 1/4" and 3/8" course thread diameter sizes
- Ergonomically designed handle provides a more comfortable hand position for increased comfort and less fatigue
- Compact and ergonomic design at only 7-7/8" long and weighs only 7 lbs. with battery (battery not included)
- Automatic blade stop mechanism returns blade to open position once cut is complete to continue operation

XCS03Z Includes: Tool only, battery & charger not included

Blade Configuration	Double sided
Max. Cutting Capacity	3/8"
Min. Cutting Capacity	1/4"
Battery	18V LXT® Lithium-Ion
Overall Length	7-7/8"
Net Weight (with battery)	7 lbs.
Shipping Weight	7.06 lbs.





PV7001C

7" Vertical Polisher

- Quick-Flip™ speed change for compounding and polishing
- 2-speed selection button: low (600 RPM) and variable (600-2,000 RPM)
- Advanced electronics include soft start and electronic speed control
- Refined design at 4.8 lbs. for reduced operator fatigue
- Motor-over-pad design for improved balance
- Variable speed control dial enables user to match the speed to the application

PV7001C Includes: 7" Backing Pad, Hook & Loop (743052-5), Air Deflector (417793-6), Spanner Wrench (781008-0), Side Handle (152491-2)

Sanding Disc	7"
Wool Bonnet	7"
No Load Speed	600 RPM
No Load Speed (variable speed)	600 - 2,000 RPM
Spindle Thread	5/8" - 11 UNC
AMPS	7.9
Overall Length	8-1/4"
Net Weight	4.8 lbs.
Shipping Weight	6.7 lbs.



PK5011CX1

5" Electronic Stone Polisher

- Powerful 11 AMP motor delivers more output for the most demanding applications
- Variable speed control dial (2,000 - 5,500) enables user to match the speed to the application
- Adjustable water flow valve is conveniently located
- Water supply tube is directed through the handle for maneuverability and comfort
- Four water outlets around the arbor efficiently distributes water to the pad for increased dust containment
- Sealed trigger helps prevent water from entering housing

PK5011CX1 Includes: Protective Head Cover (418529-6), Splash Guard (195773-9), Lock Nut Wrench (782412-6), Side Handle (152539-0)

Disc Size (in.)	5"
No Load Speed (variable speed)	2,000 - 5,500 RPM
Spindle Thread	5/8" - 11 UNC
AMPS	11
Overall Length	18-1/2"
Net Weight	8.4 lbs.
Shipping Weight	12.5 lbs.



PW5001C

4" Electronic Stone Polisher

- Variable speed control dial enables user to match the speed to the application
- Soft-start feature for smooth start-ups
- Electronic speed control maintains constant speed under load
- Common fitting accepts the most popular water hose connections
- Housing cover protects the industrial die cast aluminum gear housing
- Includes a Ground Fault Circuit Interrupter (GFCI) plug

PW5001C Includes: 4" Rubber Pad (743079-5), Side Handle (153489-2), Head Cover (417322-5), Spanner Wrench (781008-0), Front Grip (418507-6), Wrench (783204-6), Dust Cover (194233-8)

Polishing Disc	4"
No Load Speed (variable speed)	2,000 - 4,000 RPM
Spindle Thread	5/8" - 11 UNC
AMPS	7.9
Overall Length	14-1/8"
Net Weight	5.1 lbs.
Shipping Weight	8.36 lbs.



9227C

7" Polisher

- Powerful 10 AMP motor delivers 3,200 RPM
- Variable speed control dial enables user to match the speed to the application
- Constant speed control automatically applies additional power to the motor to maintain speed under load
- Soft start suppresses start-up reaction for less fling-off
- Large two-finger trigger switch for convenience
- Lock-on button for continuous operation

9227C Includes: 7" Backing Pad, Hook & Loop (743052-5), Wrench (783204-6), Side Handle (153489-2), Loop Handle (416256-9)

Sanding Disc	7"
Wool Bonnet	7"
No Load Speed (variable speed)	0 - 3,200 RPM
Spindle Thread	5/8" - 11 UNC
AMPS	10
Overall Length	18-1/2"
Net Weight	6.8 lbs.
Shipping Weight	9 lbs.



9237C

7" Polisher

- Variable speed dial and trigger enables user to match the speed to the application
- Soft start for smooth start-ups and less fling off of polish, wax or paste
- Rubberized loop handle and gear housing to help protect delicate surfaces from damage
- Wire mesh intake covers to prevent wool fibers from entering the motor
- Lock-on button for continuous use operation
- Includes pad alignment/centering sleeve

9237C Includes: 7" Backing Pad, Hook & Loop (743052-5), Wrench (783204-6), Side Handle (153489-2), Loop Handle 9237C (455292-0), Pad Alignment/Centering Sleeve (262542-4)

Sanding Disc	7"
Wool Bonnet	8"
No Load Speed (variable speed)	0 - 3,200 RPM
Spindle Thread	5/8" - 11 UNC
AMPS	10
Overall Length	18-1/2"
Net Weight	7 lbs.
Shipping Weight	10 lbs.



9237CX3

7" Polisher

- Variable speed dial and trigger enables user to match the speed to the application
- Soft start for smooth start-ups and less fling off of polish, wax or paste
- Rubberized loop handle and gear housing to help protect delicate surfaces from damage
- Wire mesh intake covers to prevent wool fibers from entering the motor
- Lock-on button for continuous use operation
- Includes pad alignment/centering sleeve

9237CX3 Includes: 7" Backing Pad, Hook & Loop (743052-5), Wrench (783204-6), Side Handle (153489-2), Tool Bag (821016-X), 7" Wool Bonnet, Hook and Loop, Compounding (192629-7), 7" Wool Bonnet, Hook and Loop, Polishing (743403-A), Loop Handle 9237C (455292-0), Pad Alignment/Centering Sleeve (262542-4)

Sanding Disc	7"
Wool Bonnet	8"
No Load Speed (variable speed)	0 - 3,200 RPM
Spindle Thread	5/8" - 11 UNC
AMPS	10
Overall Length	18-1/2"
Net Weight	7 lbs.
Shipping Weight	13.45 lbs.



P05000C

5" Dual Action Random Orbit Polisher

- Powerful 7.8 AMP motor delivers more output and variable (0 - 780) RPM
- 7/32" (5.5mm) orbit diameter provides a swirl-free finish
- Conveniently located variable speed control dial (0 - 6,800 OPM) enables the operator to match the speed to the application
- Electronic controller provides constant speed control which automatically applies additional power to the motor to maintain speed under load
- Electronic Controller provides soft start which is designed to suppress start-up reaction for smooth start-ups and longer gear life
- Air vent intake covers help prevent fibers from entering the motor

P05000C Includes: Hex Wrench (783203-8), 5" Plastic Backing Plate, Hook & Loop (197923-2)

Pad Size (round)	5"
AMPS	7.8
No Load Speed (variable speed)	0 - 780 RPM
Orbits Per Minute (variable speed)	0 - 6,800 OPM
Orbit Diameter	7/32"
Variable speed control dial	Yes
Vibration (m/s ²)	4.5
Overall Length	17-3/4"
Net Weight	6.2 lbs.
Shipping Weight	9 lbs.



P05000CX2

5" Dual Action Random Orbit Polisher

- Powerful 7.8 AMP motor delivers more output and variable (0 - 780) RPM
- 7/32" (5.5mm) orbit diameter provides a swirl-free finish
- Conveniently located variable speed control dial (0 - 6,800 OPM) enables the operator to match the speed to the application
- Electronic controller provides constant speed control which automatically applies additional power to the motor to maintain speed under load
- Electronic Controller provides soft start which is designed to suppress start-up reaction for smooth start-ups and longer gear life
- Air vent intake covers help prevent fibers from entering the motor

P05000CX2 Includes: Hex Wrench (783203-8), 5" Plastic Backing Plate, Hook & Loop (197923-2), 5-1/2" Hook and Loop Foam Polishing Pad, White (T-02668), 5-1/2" Hook and Loop Foam Polishing Pad, Orange (T-02674), 5-1/2" Hook and Loop Foam Polishing Pad, Black (T-02680)

Pad Size (round)	5"
AMPS	7.8
No Load Speed (variable speed)	0 - 780 RPM
Orbits Per Minute (variable speed)	0 - 6,800 OPM
Orbit Diameter	7/32"
Variable speed control dial	Yes
Vibration (m/s ²)	4.5
Overall Length	17-3/4"
Net Weight	6.2 lbs.
Shipping Weight	12 lbs.





5008MGA

8-1/4" Magnesium Circular Saw

- Magnesium components create a lightweight saw (11.4 lbs.) that is well balanced and job site tough
- Large cutting capacity (3" at 90°) and bevel capacity (0° - 50°) with positive stops at 22.5° and 45°
- Two built-in L.E.D. lights illuminate the line of cut for increased accuracy
- Electric brake for maximum productivity
- Powerful 15.0 AMP motor delivers 5,200 RPM for proven performance
- Built-in dust blower clears the line of cut for greater accuracy

5008MGA Includes: 8-1/4" 24T Carbide-Tipped Saw Blade, Framing (D-21521), Wrench (783204-6), Rip Fence (164095-8)

Blade Diameter	8-1/4"
Arbor	5/8"
Max. Cutting Capacity (at 90°)	3"
Max. Cutting Capacity (at 45°)	2-1/4"
Max. Cutting Capacity (at 50°)	2"
No Load Speed	5,200 RPM
Watts Out	2,300
AMPS	15
Overall Length	13-1/8"
Net Weight	11.4 lbs.
Shipping Weight	15.21 lbs.



5007MG / 5007MGA

7-1/4" Magnesium Circular Saw

- Magnesium components create a lightweight saw that's job site tough
- Large rubberized levers for quick and easy one-handed adjustments
- Large cutting capacity (2-1/2" at 90°) and bevel capacity (0°-56°) with positive stops at 22.5°, 45°, and 56°
- Two built-in L.E.D. lights illuminate the line of cut
- Includes premium blade for faster cutting, rip fence for accurate rip cutting, attached blade wrench for convenience and a tool case

5007MG Includes: 7-1/4" 24T Ultra-Coated C.T. Saw Blade (A-94530-A), Wrench (783204-6), Rip Fence (164095-8), Tool Case (824772-1)

5007MGA Includes: 7-1/4" 24T Ultra-Coated C.T. Saw Blade (A-94530-A), Wrench (783204-6), Rip Fence (164095-8), Tool Case (824772-1)

Blade Diameter	7-1/4"
Arbor	5/8"
Max. Cutting Capacity (at 90°)	2-1/2"
Max. Cutting Capacity (at 45°)	1-3/4"
Max. Cutting Capacity (at 56°)	1-3/8"
No Load Speed	5,800 RPM
Watts Out	2,300
AMPS	15
Overall Length	12-1/2"
Net Weight	10.6 lbs.
Shipping Weight	17.95 lbs.



5007F / 5007FA

7-1/4" Circular Saw

- Powerful 15 AMP motor delivers 5,800 RPM for proven performance and jobsite durability
- Lower guard design improves performance when making bevel and narrow cuts
- Large cutting capacity (2-3/8" at 90°, 1-3/4" at 45°)
- Two built-in LED lights illuminate the line of cut for increased accuracy
- Well balanced design for superior handling and performance
- Ideal for framers, builders, forming, and siding contractors

5007F Includes: 7-1/4" 24T Framing Blade, General Contractor (D-45989-1), Offset Wrench (782016-4)

5007FA Includes: 7-1/4" 24T Framing Blade, General Contractor (D-45989-1), Offset Wrench (782016-4)

Blade Diameter	7-1/4"
Arbor	5/8"
Max. Cutting Capacity (at 90°)	2-3/8"
Max. Cutting Capacity (at 45°)	1-3/4"
No Load Speed	5,800 RPM
Watts Out	2,000
AMPS	15
Overall Length	12"
Net Weight	11.1 lbs.
Shipping Weight:	5007F (14 lbs.), 5007FA (14.8 lbs.)



5007NK

7-1/4" Circular Saw

- Powerful 15 AMP motor for a high power-to-weight ratio
- Lower guard design improves performance when making bevel and narrow cuts
- Well-balanced design for superior handling and performance
- Bevel cuts 0°-56° with positive stops at 22.5°, and 45° and 56° for quick settings
- Large cutting capacity (2-1/2" at 90°, 1-3/4" at 45° and 1-3/8" at 56°)
- Ideal for framers, roofers, carpenters, masons, and general contractors

5007NK Includes: 7-1/4" 24T Framing Blade, General Contractor (D-45989-1), Offset Wrench (782016-4), Tool Case

Blade Diameter	7-1/4"
Arbor	5/8"
Max. Cutting Capacity (at 90°)	2-1/2"
Max. Cutting Capacity (at 45°)	1-3/4"
Max. Cutting Capacity (at 56°)	1-3/8"
No Load Speed	5,800 RPM
Watts Out	2,300
AMPS	15
Overall Length	12-1/2"
Net Weight	11 lbs.
Shipping Weight	20 lbs.



HS7600

7-1/4" Circular Saw

- Powerful 10.5 AMP motor deliver 5,200 RPM for performance and job site durability
- Lower guard design improves performance when making bevel and narrow cuts
- Heavy gauge aluminum wraparound base engineered for improved durability and straighter cuts
- Bevel cuts 0°-45° for the most common cutting applications
- Large and easy-to-read markings on base for more precise cutting
- Flat motor housing design for stability when changing the blade

HS7600 Includes: 7-1/4" 24T Framing Blade, General Contractor (D-45989-1), Hex Wrench (783217-7)

Blade Diameter	7-1/4"
Arbor	5/8"
Max. Cutting Capacity (at 90°)	2-1/2"
Max. Cutting Capacity (at 45°)	1-5/8"
No Load Speed	5,200 RPM
Watts Out	1,400
AMPS	10.5
Overall Length	12-1/8"
Net Weight	8.6 lbs.
Shipping Weight	11.22 lbs.



HS7610

7-1/4" Circular Saw

- Well-balanced and lightweight (8.7 lbs.) for superior handling and performance
- Powerful 14 AMP motor deliver 5,500 RPM for performance and job site durability
- Heavy gauge aluminum wraparound base engineered for improved durability and straighter cuts
- Included dust nozzle accessory directs material away from the operator; allows connection to a vacuum for improved dust collection
- Bevel cuts 0°- 45° for the most common cutting applications
- Ergonomic rubberized front grip and handle provides added comfort

HS7610 Includes: 7-1/4" 24T Framing Blade, General Contractor (D-45989-1), Hex Wrench (783217-7), Dust Extracting Attachment (196520-1)

Blade Diameter	7-1/4"
Arbor	5/8"
Max. Cutting Capacity (at 90°)	2-1/2"
Max. Cutting Capacity (at 45°)	1-3/4"
No Load Speed	5,500 RPM
Watts Out	1,600
AMPS	14
Overall Length	12-1/4"
Net Weight	8.7 lbs.
Shipping Weight	13.8 lbs.



5057KB

7-1/4" Circular Saw, w/ Dust Collector

- Powerful 13 AMP motor delivers the power to cut five stacked 5/16" siding boards in a single pass
- Dust collector engineered to reduce the amount of dust created while cutting
- Guard is retractable for easier plunge cuts
- Bearings and switch are protected with dust proof design
- Bevel cuts from 0°-45°
- Shaft lock for fast and easy blade changes

5057KB Includes: 7-1/4" 28T Carbide-Tipped, Fiber Cement Blade (A-90451), Offset Wrench (782016-4), Rip Fence (164095-8)

Blade Diameter	7-1/4"
Arbor	5/8"
Max. Cutting Capacity (at 90°)	2-3/8"
Max. Cutting Capacity (at 45°)	1-3/16"
No Load Speed	5,800 RPM
Watts Out	2,100
AMPS	13
Overall Length	14"
Net Weight	11.8 lbs.
Shipping Weight	15.8 lbs.



5377MG

7-1/4" Magnesium Hypoid Saw

- Magnesium components create a lightweight saw (13.2 lbs.) that is well balanced and job site tough
- Oil bath technology and sealed gear housing for less maintenance
- Large cutting capacity (2-3/8" at 90°) with positive stops at 22.5°, 45° and 51.5°
- Hypoid gears have greater surface contact
- Heat treated hypoid steel gears are designed for less maintenance
- Reinforced 10 ft. cord withstands job site abuse

5377MG Includes: 7-1/4" 24T Ultra-Coated C.T. Saw Blade (A-94530-A), Wrench (783204-6)

Blade Diameter	7-1/4"
Arbor	5/8"
Max. Cutting Capacity (at 90°)	2-3/8"
Max. Cutting Capacity (at 45°)	1-3/4"
Max. Cutting Capacity (at 50°)	1-9/16"
No Load Speed	4,500 RPM
Watts Out	2,300
AMPS	15
Overall Length	17-3/4"
Net Weight	13.2 lbs.
Shipping Weight	17.35 lbs.

THE ADVANCED STANDARD



5477NB

7-1/4" Hypoid Saw

- Hypoid gears deliver more power and have greater surface contact than conventional worm drive gears
- Powerful 15 AMP motor for increased productivity
- Oil bath technology and sealed gear housing for less maintenance
- 0° - 51.5° bevel capacity with positive stops at 45° and 51.5°, ideal for truss and rafter cut-outs
- Large cutting capacity (2-3/8" at 90°; 1-3/4" at 45°; 1-9/16" at 50°)
- Large levers for fast bevel and depth adjustments

5477NB Includes: 7-1/4" 24T Framing Blade, General Contractor (D-45989-1), Wrench (783204-6)

Blade Diameter	7-1/4"
Arbor	5/8"
Max. Cutting Capacity (at 90°)	2-3/8"
Max. Cutting Capacity (at 45°)	1-3/4"
Max. Cutting Capacity (at 50°)	1-9/16"
No Load Speed	4,500 RPM
Watts Out	2,300
AMPS	15
Overall Length	17-3/8"
Net Weight	14.3 lbs.
Shipping Weight	18.07 lbs.



LXT BRUSHLESS **AWS**

XSH07PTU

XSH07ZU

18V X2 LXT® (36V) Brushless 7-1/4" Circular Saw Kit, AWS™ Capable

- X2 LXT® technology delivers up to 610 crosscuts per charge in 2x4 SPF lumber using two 5.0Ah batteries
- Auto-Start Wireless System (AWS™) utilizes Bluetooth® technology for wireless power-on/off communication between tool and optional dust extractor
- AWS™ capable with Auto-Start Wireless Transmitter (part no. 198901-5) sold separately
- Automatic Speed Change™ technology adjusts cutting speed and torque during cut for optimum performance

XSH07PTU Includes: 18V LXT® Lithium-Ion Dual Port Charger (DC18RD), (2) 18V LXT® Lithium-Ion 5.0Ah Battery (BL1850B), 7-1/4" 24T C.T. Circular Saw Blade (B-61656), Wrench (783204-6), Tool Bag (831271-6), Dust Extracting Attachment (196520-1)

XSH07ZU Includes: Tool only, battery & charger not included 7-1/4" 24T C.T. Circular Saw Blade (B-61656), Wrench (783204-6), Dust Extracting Attachment (196520-1)

Blade Diameter	7-1/4"
Arbor	5/8"
No Load Speed	6,000 RPM
Max. Cutting Capacity (at 45°)	1-13/16"
Max. Cutting Capacity (at 50°)	1-5/16"
Max. Cutting Capacity (at 90°)	2-5/8"
Battery	2X 18V LXT® Lithium-Ion
Overall Length	13-1/2"
Net Weight (with battery)	10.5 lbs.



DESIGN

0° - 56° bevel capacity with positive stops at 22.5°, 45°, and 56°

PERFORMANCE

Delivers up to 610 cross-cuts per charge in 2x4 SPF using two LXT® 5.0Ah batteries

LXT BRUSHLESS

XSH06PT

18V X2 LXT® (36V) Brushless 7-1/4" Circular Saw Kit

- X2 LXT® technology delivers up to 610 crosscuts per charge in 2x4 SPF lumber using two 5.0Ah batteries
- Automatic Speed Change™ technology adjusts cutting speed and torque during cut for optimum performance
- Extreme Protection Technology (XPT™) is engineered for improved dust and water resistance for operation in harsh conditions
- Large 2-5/8" cutting capacity at 90°
- Electric brake for maximum productivity
- 0° - 56° bevel capacity with positive stops at 22.5°, 45°, and 56°
- Die-cast magnesium base, blade guard, and blade cover provide a lightweight, durable design
- Built-in tether notch (tether sold separately)
- Dual L.E.D. lights illuminate the work area

XSH06PT Includes: 18V X2 LXT® (36V) Brushless 7-1/4" Circular Saw (XSH06Z), (2) 18V LXT® Lithium-Ion 5.0Ah Battery (BL1850B), 18V LXT® Lithium-Ion Dual Port Charger (DC18RD), 7-1/4" 24T C.T. Circular Saw Blade (B-61656), Wrench (783204-6), Dust Extracting Attachment (196520-1)

XSH06Z Includes: Tool only, battery & charger not included 7-1/4" 24T C.T. Circular Saw Blade (B-61656), Wrench (783204-6), Dust Extracting Attachment (196520-1)

Blade Diameter	7-1/4"
Arbor	5/8"
No Load Speed	6,000 RPM
Max. Cutting Capacity (at 45°)	1-13/16"
Max. Cutting Capacity (at 50°)	1-5/16"
Max. Cutting Capacity (at 90°)	2-5/8"
Battery	2X 18V LXT® Lithium-Ion
Overall Length	13-1/2"
Net Weight (with battery)	10.5 lbs.
Shipping Weight	21.21 lbs.



LXT BRUSHLESS

XSR01PT

XSR01Z

18V X2 LXT® (36V) Brushless Rear Handle 7-1/4" Circular Saw Kit

- X2 LXT® technology delivers up to 558 cross-cuts per charge in 2x4 SPF lumber using the two 5.0Ah batteries
- Large 2-9/16" cutting capacity at 90°; cuts 3X material in a single pass
- Automatic Speed Change™ technology adjusts cutting speed and torque during cut for optimum performance
- Electric brake for maximum productivity
- 0° - 53° bevel capacity with positive stops at 22.5°, 45°, and 53°

XSR01PT Includes: 18V X2 LXT® (36V) Brushless Rear Handle 7-1/4" Circular Saw (XSR01Z), (2) 18V LXT® Lithium-Ion 5.0Ah Battery (BL1850B), 18V LXT® Lithium-Ion Dual Port Charger (DC18RD), 7-1/4" 24T Ultra-Coated C.T. Saw Blade (A-94530-A), Wrench (783204-6), Tool Bag (831271-6)

XSR01Z Includes: Tool only, battery & charger not included 7-1/4" 24T Ultra-Coated C.T. Saw Blade (A-94530-A), Wrench (783204-6)

Blade Diameter	7-1/4"
Arbor	5/8"
Max. Cutting Capacity (at 90°)	2-9/16"
Max. Cutting Capacity (at 45°)	1-3/4"
Max. Cutting Capacity (at 53°)	1-1/2"
No Load Speed	5,100 RPM
Battery	2X 18V LXT® Lithium-Ion
Overall Length	17-1/2"
Net Weight (with battery)	12.4 lbs.
Shipping Weight	24.2 lbs.



LXT BRUSHLESS

XSH03T

XSH03Z

18V LXT® Brushless 6-1/2" Circular Saw Kit

- Powerful Makita built electronically controlled BL™ Motor delivers 5,000 RPM for faster cutting and ripping
- Automatic Speed Change™ technology adjusts speed and torque during operation for optimum performance
- Compact and ergonomic blade-left design at only 13-3/4" long
- Weighs only 7.3 lbs. with battery for reduced operator fatigue
- Large cutting capacity (2-1/4" at 90°) and bevel capacity (0° - 50°)
- Only use genuine Makita batteries and chargers

XSH03T Includes: 18V LXT® Brushless 6-1/2" Circular Saw (XSH03Z), (2) 18V LXT® Lithium-Ion 5.0Ah Battery (BL1850B), 18V LXT® Lithium-Ion Rapid Optimum Charger (DC18RC), 6-1/2" 24T C.T. Saw Blade (A-85092), Tool bag

XSH03Z Includes: Tool only, battery & charger not included 6-1/2" 24T C.T. Saw Blade (A-85092)

Blade Diameter	6-1/2"
Arbor	5/8"
Max. Cutting Capacity (at 90°)	2-1/4"
Max. Cutting Capacity (at 45°)	1-5/8"
Max. Cutting Capacity (at 50°)	1-7/16"
No Load Speed	5,000 RPM
Battery	18V LXT® Lithium-Ion
Overall Length	13-3/4"
Net Weight (with battery)	7.3 lbs.
Shipping Weight	15.7 lbs.



LXT BRUSHLESS **AWS**

XSH05ZB

18V LXT® Sub-Compact Brushless 6-1/2" Circular Saw, AWS™ Capable

- Auto-Start Wireless System (AWS™) utilizes Bluetooth® technology for wireless power-on/off communication between tool and optional dust extractor
- AWS™ capable with Auto-Start Wireless Transmitter (part no. 198901-5) sold separately
- Compact and ergonomic blade-right design at only 10-5/8" long
- Weighs only 6.4 lbs. with 2.0Ah battery (battery not included) for operator comfort
- Powerful Makita built electronically controlled BL™ Motor delivers 5,000 RPM for faster cutting and ripping
- The BL™ Brushless Motor eliminates carbon brushes, enabling the BL™ Motor to run cooler and more efficiently for longer life

XSH05ZB Includes: 6-1/2" 24T C.T. Saw Blade (A-85092), Dust Extracting Attachment (199230-9), Hex Wrench (783203-8)

Blade Diameter	6-1/2"
Arbor	5/8"
No Load Speed	5,000 RPM
Max. Cutting Capacity (at 90°)	2-1/4"
Max. Cutting Capacity (at 45°)	1-5/8"
Overall Length	10-5/8"
Net Weight (with battery)	6.4 lbs.
Blade Location	Right
Automatic-start Wireless System (AWS™) Capable (transmitter sold separately)	
Shipping Weight	7.5 lbs.



LXT BRUSHLESS

XSH04RB

XSH04ZB

18V LXT® Sub-Compact Brushless 6-1/2" Circular Saw Kit

- Compact and ergonomic blade-right design at only 10-5/8" long
- Weighs only 6.4 lbs. with battery for operator comfort
- Powerful Makita built electronically controlled BL™ Motor delivers 5,000 RPM for faster cutting and ripping
- The BL™ Brushless Motor eliminates carbon brushes, enabling the BL™ Motor to run cooler and more efficiently for longer life
- Large cutting capacity (2-1/4" at 90°) and bevel capacity (0° - 50°)

XSH04RB Includes: 18V LXT® Sub-Compact Brushless 6-1/2" Circular Saw (XSH04ZB), (2) 18V LXT® Lithium-Ion Compact 2.0Ah Battery (BL1820B), 18V LXT® Lithium-Ion Rapid Optimum Charger (DC18RC), 6-1/2" 24T C.T. Saw Blade (A-85092), Hex Wrench (783203-8), Dust Extracting Attachment (199230-9)

XSH04ZB Includes: Tool only, battery & charger not included 6-1/2" 24T C.T. Saw Blade (A-85092), Dust Extracting Attachment (199230-9), Hex Wrench (783203-8)

Blade Diameter	6-1/2"
Arbor	5/8"
No Load Speed	5,000 RPM
Max. Cutting Capacity (at 90°)	2-1/4"
Max. Cutting Capacity (at 45°)	1-5/8"
Overall Length	10-5/8"
Net Weight (with battery)	6.4 lbs.
Blade Location	Right



SP6000J shown

SP6000J / SP6000J1

6-1/2" Plunge Circular Saw

- 12 AMP motor with variable speed control dial (2,000 - 5,200 RPM)
- Close to the wall cutting (11/16") for expanded cutting applications
- Electronic speed control maintains constant speed under load for smooth cutting
- Ideal for cutting large wood panels and other wood materials in confined areas
- Dual front and rear bevel supports provide additional rigidity for precise and accurate bevel cuts

SP6000J Includes: 6-1/2" 48T Carbide-Tipped Saw Blade (B-07353), Hex Wrench (783203-8), Interlocking Case, X-Large (197213-3)

SP6000J1 Includes: 6-1/2" Plunge Circular Saw (SP6000J), 6-1/2" 48T Carbide-Tipped Saw Blade (B-07353), Hex Wrench (783203-8), Interlocking Case, X-Large (197213-3), 55" Guide Rail (194368-5)

Blade Diameter	6-1/2"
Arbor (mm)	20 mm
Max. Cutting Capacity (at 90°)	2-3/16"
Max. Cutting Capacity (at 45°)	1-9/16"
No Load Speed (variable speed)	2,000 - 5,200 RPM
Watts Out	1,800
AMPS	12
Overall Length	13-3/8"
Net Weight:	SP6000J (9.7 lbs.), SP6000J1 (16.5 lbs.)
Shipping Weight:	SP6000J (17.9 lbs.), SP6000J1 (27.25 lbs.)



LXT BRUSHLESS

AWS

XPS02PTU

XPS02ZU

18V X2 LXT® (36V) Brushless 6-1/2" Plunge Circular Saw Kit, AWS™

- Auto-Start Wireless System (AWS™) utilizes Bluetooth® technology for wireless power-on/off communication between tool and optional dust extractor
- X2 LXT® technology delivers up to 125 cuts per charge in 4x8 sheets of 1/2" plywood per charge using two 5.0Ah batteries
- Ideal for large wood panels, other wood materials like melamine and MDF, aluminum, and Corian® (includes wood blade, other blades sold separately)

XPS02PTU Includes: 18V LXT® Lithium-Ion Dual Port Charger (DC18RD), (2) 18V LXT® Lithium-Ion 5.0Ah Battery (BL1850B), Interlocking Case, X-Large (197213-3), Interlocking Case, Medium (197211-7), 6-1/2" 56T C.T. Cordless Plunge Saw Blade, Wood, MDF, Laminate (B-57342), Auto-Start Wireless Transmitter (196901-5), Hex Wrench (783203-8)

XPS02ZU Includes: Tool only, battery & charger not included 6-1/2" 56T C.T. Cordless Plunge Saw Blade, Wood, MDF, Laminate (B-57342), Auto-Start Wireless Transmitter (196901-5), Hex Wrench (783203-8)

Blade Diameter	6-1/2"
Arbor (mm)	20 mm
Max. Cutting Capacity (at 90°)	2-3/16"
Max. Cutting Capacity (at 45°)	1-9/16"
No Load Speed (variable speed)	2,500 - 6,300 RPM
Battery	2X 18V LXT® Lithium-Ion
Overall Length	13-5/8"
Net Weight (with battery)	11.2 lbs.
Automatic-start Wireless System (AWS™)	Yes (Transmitter Included)



LXT BRUSHLESS

XPS01PTJ

XPS01Z

18V X2 LXT® (36V) Brushless 6-1/2" Plunge Circular Saw Kit

- X2 LXT® technology delivers up to 125 cuts per charge in 4x8 sheets of 1/2" plywood per charge using two 5.0Ah batteries
- Ideal for large wood, other wood materials like melamine and MDF, aluminum, and Corian® (includes wood blade, other blades sold separately)
- Built-in depth stop allows a preliminary first cut for clean and splinter-free cutting prior to the full cutting of sheet
- Slide lever on saw base designed to engage the optional guide rail (sold separately) when bevel cutting for stability

XPS01PTJ Includes: 18V X2 LXT® (36V) Brushless 6-1/2" Plunge Circular Saw (XPS01Z), (2) 18V LXT® Lithium-Ion 5.0Ah Battery (BL1850B), 18V LXT® Lithium-Ion Dual Port Charger (DC18RD), 6-1/2" 55T C.T. Cordless Plunge Saw Blade, Wood, MDF, Lam. (B-57071), Hex Wrench (783203-8), Interlocking Case, X-Large (197213-3), Interlocking Case, Medium (197211-7)

XPS01Z Includes: Tool only, battery & charger not included Hex Wrench (783203-8), 6-1/2" C.T. Cordless Plunge Saw Blade, Wood, MDF, Lam.

Blade Diameter	6-1/2"
Arbor (mm)	20 mm
Max. Cutting Capacity (at 90°)	2-3/16"
Max. Cutting Capacity (at 45°)	1-9/16"
No Load Speed (variable speed)	2,500 - 6,300 RPM
Battery	2X 18V LXT® Lithium-Ion
Overall Length	13-5/8"
Net Weight (with battery)	11.2 lbs.
Shipping Weight	28 lbs.



LXT

XSS01T

XSS01Z

18V LXT® 6-1/2" Circular Saw Kit

- Makita-built motor delivers 3,700 RPM for faster cutting and ripping through wood
- Built-in L.E.D. light illuminates the work area
- 50° maximum bevel cutting capacity
- Built-in dust blower keeps the line of cut free of debris for more accurate cuts
- Heavy gauge, precision machined base for smooth, accurate cutting and added durability
- Electric brake for maximum productivity

XSS01T Includes: 18V LXT® 6-1/2" Circular Saw (XSS01Z), (2) 18V LXT® Lithium-Ion 5.0Ah Battery (BL1850B), 18V LXT® Lithium-Ion Rapid Optimum Charger (DC18RC), 6-1/2" 24T C.T. Saw Blade (A-85092), Rip Fence (164095-8), Tool Case (824757-7)

XSS01Z Includes: Tool only, battery & charger not included 6-1/2" 24T C.T. Saw Blade (A-85092), Rip Fence (164095-8)

Blade Diameter	6-1/2"
Arbor	5/8"
Max. Cutting Capacity (at 90°)	2-1/4"
Max. Cutting Capacity (at 45°)	1-9/16"
No Load Speed	3,700 RPM
Battery	18V LXT® Lithium-Ion
Overall Length	13-5/8"
Net Weight (with battery)	7.6 lbs.
Shipping Weight	19 lbs.



LXT

XSS03Z

18V LXT® 5-3/8" Circular Trim Saw

- Makita-built motor delivers 3,600 RPM for faster cutting and ripping through wood
- Weighs only 6.0 lbs. with battery (battery not included) for reduced operator fatigue
- Built-in dust blower keeps the line of cut free of debris for more accurate cuts
- Heavy gauge, precision machined base for smooth, accurate cutting and added durability
- Electric brake for maximum productivity
- Built-in L.E.D. light illuminates the work area

XSS03Z Includes: Tool only, battery & charger not included 5-3/8" 16T C.T. Saw Blade (A-94904), Rip Fence (164095-8), Hex Wrench (783203-8)

Blade Diameter	5-3/8"
Arbor	5/8"
Max. Cutting Capacity (at 90°)	2"
Max. Cutting Capacity (at 45°)	1-3/8"
No Load Speed	3,600 RPM
Battery	18V LXT® Lithium-Ion
Overall Length	14-3/8"
Net Weight (with battery)	6 lbs.
Shipping Weight	8.1 lbs.



5005BA

5-1/2" Circular Saw

- Powerful 8.0 AMP motor for faster cutting and improved performance
- Blade-left design improves visibility of cutting line
- Compact and lightweight (6.2 lbs.) for increased comfort
- Electric brake for maximum productivity
- Lock-off button for user convenience
- Shaft lock for fast blade changes

5005BA Includes: 5-1/2" 18T Carbide-Tipped Circular Saw Blade (792335-0), Rip Fence (164095-8), Socket Wrench (782209-3)

Blade Diameter	5-1/2"
Arbor	5/8"
Max. Cutting Capacity (at 90°)	1-3/4"
Max. Cutting Capacity (at 45°)	1-3/16"
No Load Speed	8,000 RPM
Watts Out	1,050
AMPS	8
Overall Length	9-13/16"
Net Weight	6.2 lbs.
Shipping Weight	9 lbs.

SAW ACCESSORIES

194367-7	194368-5	199140-0
118" Guide Rail	55" Guide Rail	39" Guide Rail

P-45777

Guide Rail Connector Kit

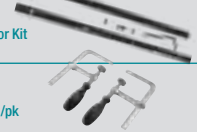

194385-5

Guide Rail Clamp, 2/pk

CORDLESS PLUNGE SAW BLADES

B-57342

6-1/2" 56T C.T. Max Efficiency Cordless Plunge Saw Blade, Wood, MDF, Laminate



A-98809

6-1/2" 48T C.T. Cordless Plunge Saw Blade, Corian®



A-99932

6-1/2" 48T C.T. Cordless Plunge Saw Blade, Wood



A-99960

6-1/2" 28T C.T. Cordless Plunge Saw Blade, Wood



A-99976

6-1/2" 56T C.T. Cordless Plunge Saw Blade, Aluminum



A-99982

6-1/2" 60T (ATB) C.T. Cordless Plunge Saw Blade, MDF



A-99998

6-1/2" 60T (TCG) C.T. Cordless Plunge Saw Blade, MDF



HS0600

10-1/4" Circular Saw

- Delivers trusted performance of Makita 5007F 7-1/4" Circular Saw with the added 10-1/4" capacity to cut 4x lumber in a single pass
- Powerful 15 AMP motor delivers 4,300 RPM with power to cut beams, engineered lumber, and timber
- Well balanced design at 16-1/2" long and weighing only 15.2 lbs. for increased operator comfort
- Auxiliary front and top handles are positioned for comfort and control
- Compatible with Makita dust management system for a cleaner work environment (dust extraction accessories sold separately)
- Large cutting capacity (3-13/16" at 90° and 2-11/16" at 45°)

HS0600 Includes: 10-1/4" 24T Carbide-Tipped Saw Blade, Framing (A-94910), Rip Fence, Wrench, Wrench Holder

Blade Diameter	10-1/4"
Arbor	5/8"
Max. Cutting Capacity (at 90°)	3-13/16"
Max. Cutting Capacity (at 45°)	2-11/16"
No Load Speed	4,300 RPM
Watts Out	1,900
AMPS	15
Overall Length	16-1/2"
Net Weight	15.2 lbs.
Shipping Weight	22.6 lbs.



5104

10-1/4" Circular Saw

- 14 AMP motor delivers enough power to cut beams and timber
- Cuts 4x lumber in a single pass
- Well balanced and weighs only 20.3 lbs. for increased operator comfort
- Precision gearing with ball-and-needle bearing construction
- Electric brake for maximum productivity
- Large cutting and bevel capacity (3-3/4" at 90° and 2-3/4" at 45°)

5104 Includes: 10-1/4" 24T Carbide-Tipped Saw Blade, Framing (A-94910), Wrench (783204-6), Rip Fence (165499-7)

Blade Diameter	10-1/4"
Arbor	5/8"
Max. Cutting Capacity (at 90°)	3-3/4"
Max. Cutting Capacity (at 45°)	2-3/4"
No Load Speed	3,800 RPM
Watts Out	2,100
AMPS	14
Overall Length	16"
Net Weight	20.3 lbs.
Shipping Weight	26.7 lbs.



5402NA

16-5/16" Circular Saw

- Powerful 15 AMP motor delivers enough power to cut through pressure treated lumber
- Cuts 6x material at 90° and 4x material at 45° in a single pass
- Weighs only 32.1 lbs. for increased operator comfort
- Electric brake for maximum productivity
- Ideal for cutting large timber and lumber

5402NA Includes: 16-5/16" 32T Carbide-Tipped Circular Saw Blade (A-90956), Wrench (783204-6), Rip Fence (164019-4), Saw Storage Holder (194701-1)

Blade Diameter	16-5/16"
Arbor	1"
Max. Cutting Capacity (at 90°)	6-3/16"
Max. Cutting Capacity (at 45°)	4-3/16"
No Load Speed	2,300 RPM
Watts Out	1,800
AMPS	15
Overall Length	24-1/4"
Net Weight	32.1 lbs.
Shipping Weight	43.4 lbs.



JR3070CTH

AVT® Recipro Pallet Saw - 15 AMP with High Torque Limiter

- Designed specifically for use in the pallet refurbish industry
- High torque limiter increases tool life, and is intended only for high torque applications such as dismantling pallets
- Equipped with Anti-Vibration Technology (AVT®) for increased user comfort and greater productivity
- Large 2-finger trigger with lock-on button for added convenience
- Variable speed control dial enables user to match the speed to the application
- 4-position orbital/straight cutting action

JR3070CTH Includes: Tool Only

Length of Stroke	1-1/4"
Strokes Per Minute (variable speed)	0 - 2,800 SPM
AMPS	15
Overall Length	19-1/8"
Net Weight	9.7 lbs.
Shipping Weight	12.38 lbs.



JR3070CT / JR3070CTZ

AVT® Recipro Saw - 15 AMP

- Powerful 15 AMP motor with electronic speed control maintains constant speed under load
- Equipped with Anti-Vibration Technology (AVT®) for increased user comfort and greater productivity
- 4-position orbital/straight cutting action
- Large 2-finger trigger with lock-on button for added convenience
- "Tool-less" blade change and shoe adjustment
- Built-in clutch reduces gear damage by disengaging gears if blade binds

JR3070CT Includes: 6" 6TPI Recipro Saw Blade (723054-A-1), 6" Metal Cutting Recipro Saw Blade, 18TPI (723066-A-1), Steel Tool Case

JR3070CTZ Includes: 6" 6TPI Recipro Saw Blade (723054-A-1), 6" Metal Cutting Recipro Saw Blade, 18TPI (723066-A-1), Steel Tool Case

Length of Stroke	1-1/4"
Strokes Per Minute (variable speed)	0 - 2,800 SPM
AMPS	15
Overall Length	19-1/8"
Net Weight:	JR3070CT (9.7 lbs.), JR3070CTZ (9.6 lbs.)
Shipping Weight:	JR3070CT (25.82 lbs.), JR3070CTZ (24 lbs.)



JR3050T

Recipro Saw - 11 AMP

- Variable speed trigger for precise cutting in a wide variety of applications
- "Tool-less" blade change and shoe adjustment
- Long 1-1/8 stroke for faster cutting
- Well balanced design (only 7.3 lbs.) for reduced operator fatigue
- Large 2-finger trigger with lock-on button
- Built-in dust blower clears the line of cut for greater accuracy

JR3050T Includes: 6" 6TPI Recipro Saw Blade (723054-A-1), 6" Metal Cutting Recipro Saw Blade, 18TPI (723066-A-1), Tool Case

JR3050TZ Includes: 6" 6TPI Recipro Saw Blade (723054-A-1), 6" Metal Cutting Recipro Saw Blade, 18TPI (723066-A-1), Tool Case

Length of Stroke	1-1/8"
Strokes Per Minute (variable speed)	0 - 2,800 SPM
AMPS	11
Overall Length	17-3/4"
Net Weight	7.3 lbs.
Shipping Weight	13.9 lbs.



LXT BRUSHLESS

XRJ06PT

18V X2 LXT® (36V) Brushless Recipro Saw Kit

- X2 LXT® technology delivers up to 155 cuts per charge in 2x10 SPF lumber using two 5.0Ah batteries
- Makita-built variable 2-speed brushless motor delivers 0-2,300 (Low) and 0-3,000 (High) strokes per minute
- Reinforced fixed shoe for added durability
- Refined crank mechanism design minimizes blade deflection and reduces vibration
- "Tool-less" blade change system allows for faster blade installation and removal for increased productivity

XRJ06PT Includes: 18V X2 LXT® (36V) Brushless Recipro Saw (XRJ06Z), (2) 18V LXT® Lithium-Ion 5.0Ah Battery (BL1850B), 18V LXT® Lithium-Ion Dual Port Charger (DC18RD), Tool Bag (831271-6), 6" Metal Cutting Recipro Saw Blade, 18TPI (723066-A-1)

XRJ06Z Includes: Tool only, battery & charger not included
6" Metal Cutting Recipro Saw Blade, 18TPI (723066-A-1)

Length of Stroke	1-1/4"
Max. Cutting Capacity (wood w/ 12" blade)	10"
Max. Cutting Capacity (pipe)	5-1/8"
Strokes Per Minute (var. 2 spd.)	0 - 2,300 / 0 - 3,000 SPM
Battery	2X 18V LXT® Lithium-Ion
Overall Length	17-3/4"
Net Weight (with battery)	10.2 lbs.
Shipping Weight	19.845 lbs.



LXT BRUSHLESS

XRJ05T

18V LXT® Brushless Recipro Saw Kit

- Makita-built variable 2-speed brushless motor delivers 0-2,300 (Low) & 0-3,000 (High) strokes per minute and a 1-1/4" stroke length for faster cutting
- "Tool-less" blade change system allows for faster blade installation and removal for increased productivity
- Large two-finger variable speed trigger for operator convenience
- Compact and ergonomic design at only 17-1/4" long
- Weighs only 8.2 lbs. with battery for reduced operator fatigue
- Rubberized soft grip handle provides increased comfort on the job

XRJ05T Includes: 18V LXT® Brushless Recipro Saw (XRJ05Z), (2) 18V LXT® Lithium-Ion 5.0Ah Battery (BL1850B), 18V LXT® Lithium-Ion Rapid Optimum Charger (DC18RC), Recipro Saw Blade, Tool Case

XRJ05Z Includes: Tool only, battery & charger not included
6" 6TPI Recipro Saw Blade (723054-A-1)

Length of Stroke	1-1/4"
Max. Cutting Capacity (wood w/ 12" blade)	10"
Max. Cutting Capacity (pipe)	5-1/8"
Strokes Per Minute (var. 2 spd.)	0 - 2,300 / 0 - 3,000 SPM
Battery	18V LXT® Lithium-Ion
Overall Length	17-1/4"
Net Weight (with battery)	8.2 lbs.
Shipping Weight	19.01 lbs.



LXT COMPACT

XRJ01T

18V LXT® Compact Recipro Saw Kit

- Variable speed (0 - 3,000 SPM) with a 1/2" stroke length for faster and more efficient cutting
- Makita exclusive dual-position on/off switch allows for either paddle or trigger switch operation
- "Tool-less" blade change system allows for faster blade installation and removal for increased productivity
- Compact and ergonomic design at 15-5/8" long
- Weighs only 3.9 lbs. (with battery) for reduced operator fatigue
- Built-in L.E.D. light illuminates the work area

XRJ01T Includes: 18V LXT® Compact Recipro Saw (XRJ01Z), (2) 18V LXT® Lithium-Ion 5.0Ah Battery (BL1850B), 18V LXT® Lithium-Ion Rapid Optimum Charger (DC18RC), 4" 18TPI Metal Cutting Recipro Saw Blade (723063-A-1), 4" 6TPI Wood Cutting Recipro Saw Blade (B-20432-1), Tool Bag

XRJ01Z Includes: Tool only, battery & charger not included
6" 6TPI Metal Cutting Recipro Saw Blade (B-20404-4), 4" 6TPI Wood Cutting Recipro Saw Blade (B-20432)

Length of Stroke	1/2"
Max. Cutting Capacity (wood)	2"
Max. Cutting Capacity (pipe)	2"
Strokes Per Minute (variable speed)	0 - 3,000 SPM
Battery	18V LXT® Lithium-Ion
Overall Length	15-5/8"
Net Weight (with battery)	3.9 lbs.
Shipping Weight	12.1 lbs.

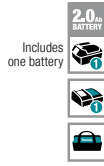

LXT BRUSHLESS

XRJ07R1B

XRJ07ZB



18V LXT® Sub-Compact Brushless Recipro Saw Kit

- Makita-built brushless motor delivers 0-3,000 strokes per minute combined with a 13/16" stroke length for faster and more efficient cutting
- Compact and ergonomic design at only 12-1/2" long
- Weighs only 5.7 lbs. with battery for reduced operator fatigue
- Ideal for working in tight spaces
- "Tool-less" blade change system allows for faster blade installation and removal for increased productivity
- Reinforced fixed shoe for added durability

XRJ07R1B Includes: 18V LXT® Sub-Compact Brushless Recipro Saw (XRJ07ZB), 18V LXT® Lithium-Ion Compact 2.0Ah Battery (BL1820B), 18V LXT® Lithium-Ion Rapid Optimum Charger (DC18RC), 4" Metal Cutting Recipro Saw Blade, 18TPI (B-20404), 4" 6TPI Wood Cutting Recipro Saw Blade (B-20432-1), Tool Bag

XRJ07ZB Includes: Tool only, battery & charger not included 4" 6TPI Wood Cutting Recipro Saw Blade (B-20432-1), 4" Metal Cutting Recipro Saw Blade, 18TPI (B-20404)

Length of Stroke	13/16"
Max. Cutting Capacity (wood w/ 12" blade)	10"
Max. Cutting Capacity (pipe)	5-1/8"
Strokes Per Minute (variable speed)	0 - 3,000 SPM
Battery	18V LXT® Compact Lithium-Ion
Overall Length	12-1/2"
Net Weight (with battery)	5.7 lbs.
Shipping Weight	10.1 lbs.



4350FCT

Top Handle Jig Saw

- 3 orbital settings plus straight cutting for use in a variety of materials
- Variable speed control dial (800 - 2,800 SPM) enables user to set the speed to the application
- "Tool-less" blade change system for fast blade installation and removal
- 40% less tool vibration with the lowest noise level in its class
- Uses Tang shank blades

4350FCT Includes: (2) 4-1/8" 9TPI Jig Saw Blade (792529-7-1), (2) Jig Saw Blade, T Shank, HCS, 4-1/8" x 9TPI (792729-9-1), (2) Jig Saw Blade, T Shank, HSS, 3" x 24TPI (792473-8-1), Anti-Splintering Insert (415524-7), Cover Plate (417852-6), Hex Wrench (783202-0), Tool Case (824809-4)

Length of Stroke	1"
Max. Cutting Capacity at 90° (wood)	5-5/16"
Max. Cutting Capacity at 90° (steel)	3/8"
Max. Cutting Capacity at 90° (aluminum)	25/32"
Strokes Per Minute (variable speed)	800 - 2,800 SPM
Blade Shank	"T" Tang
AMPS	6.3
Overall Length	9-1/4"
Net Weight	5.7 lbs.
Shipping Weight	9.4 lbs.



LXT BRUSHLESS

XVJ02Z

18V LXT® Brushless Jig Saw

- Makita-built brushless motor and 3 orbital settings plus straight cutting deliver faster and more accurate cuts in a variety of materials
- Variable 6-speed control dial (800-3,500 SPM) enables user to match the speed to the application
- Efficient BL™ Brushless motor is electronically controlled to optimize battery energy use for up to 50% longer run time per charge
- The BL™ Brushless Motor eliminates carbon brushes, enabling the BL™ Motor to run cooler and more efficiently for longer life
- The electronically-controlled BL™ Brushless Motor efficiently uses energy to match torque and SPM to the changing demands of the application
- "Tool-less" blade change system allows for faster blade installation and removal for increased productivity

XVJ02Z Includes: Tool only, battery & charger not included 4-1/8" 9TPI Jig Saw Blade (792529-7-1)

Length of Stroke	1"
Max. Cutting Capacity at 90° (wood)	5-5/16"
Max. Cutting Capacity at 90° (mild steel)	3/8"
Max. Cutting Capacity at 90° (aluminum)	25/32"
Strokes Per Minute (variable speed)	800 - 3,500 SPM
Blade Shank	"T" Tang
Battery	18V LXT® Lithium-Ion
Overall Length	10-1/2"
Net Weight (with battery)	5.8 lbs.
Shipping Weight	5.3 lbs.



LXT

XVJ03

XVJ03Z



18V LXT® Jig Saw Kit

- Makita-built variable speed motor delivers 0-2,600 SPM for faster and more efficient cutting
- 3 orbital settings plus straight cutting for use in a variety of materials
- "Tool-less" blade change system allows for faster blade installation and removal for increased productivity
- Large 2-finger variable speed trigger for added convenience
- Heavy gauge, precision machined base for smooth, accurate cutting and added durability
- Built-in L.E.D. light illuminates the work area

XVJ03 Includes: 18V LXT® Jig Saw (XVJ03Z), (2) 18V LXT® Lithium-Ion 3.0Ah Battery (BL1830B), 18V LXT® Lithium-Ion Rapid Optimum Charger (DC18RC), Jig Saw Blade, T Shank, HCS, 4-1/8" x 9TPI (792729-9-1), Anti-Splintering Insert (415524-7), Cover Plate (417852-6), Tool Bag (821016-X)

XVJ03Z Includes: Tool only, battery & charger not included Cover Plate (417852-6), 4-1/8" 9TPI Jig Saw Blade (792529-7-1)

Length of Stroke	1"
Max. Cutting Capacity at 90° (wood)	5-5/16"
Max. Cutting Capacity at 90° (steel)	3/8"
Max. Cutting Capacity at 90° (aluminum)	25/32"
Strokes Per Minute (variable speed)	0 - 2,600 SPM
Blade Shank	"T" Tang
Battery	18V LXT® Lithium-Ion
Overall Length	10-1/8"
Net Weight (with battery)	6.4 lbs.
Shipping Weight	14.7 lbs.



JV0600K

Top Handle Jig Saw

- 6.5 AMP motor and 3 orbital settings plus straight cutting deliver faster and more accurate cuts
- Variable speed control dial (500-3,100 SPM) enables user to match the speed to the application
- Through-the-body dust port for use with a vacuum provides efficient dust management (vacuum sold separately)
- Counterbalance system for reduced vibration
- "Tool-less" blade change system for fast blade installation and removal
- Uses "T" shank blades (Tang shank)

JV0600K Includes: 4-1/8" 9TPI Jig Saw Blade (792529-7-1), Hex Wrench (783201-2), Tool Case (824998-5)

Length of Stroke	7/8"
Max. Cutting Capacity at 90° (wood)	3-1/2"
Max. Cutting Capacity at 90° (steel)	3/8"
Strokes Per Minute (variable speed)	500 - 3,100 SPM
Blade Shank	"T" Tang
AMPS	6.5
Overall Length	9-1/4"
Net Weight	5.2 lbs.
Shipping Weight	9.19 lbs.



4329K

Top Handle Jig Saw

- Variable speed control dial (500 - 3,100 SPM) enables user to set the speed to the application
- Ergonomically designed rubberized grip for more comfort
- Counterweight balancing system for reduced vibration
- Die-cast aluminum base adjusts up to 45° right or left and positive stop at 90° for solid cutting performance
- Through-the-body dust port provides optimal dust management with use of clear dust cover and vacuum
- Uses Tang shank blades

4329K Includes: 4-1/8" 9TPI Jig Saw Blade (792529-7-1), Hex Wrench (783201-2), Tool Case (824572-9)

Length of Stroke	11/16"
Max. Cutting Capacity at 90° (wood)	2-9/16"
Max. Cutting Capacity at 90° (steel)	1/4"
Strokes Per Minute (variable speed)	500 - 3,100 SPM
Blade Shank	"T" Tang
AMPS	3.9
Overall Length	8-7/8"
Net Weight	4.2 lbs.
Shipping Weight	7.7 lbs.



4351FCT

Barrel Grip Jig Saw

- 40% less tool vibration with the lowest noise level in its class
- 3 orbital settings plus straight cutting for use in a variety of materials
- Variable speed control dial (800 - 2,800 SPM) enables user to set the speed to the application
- "Tool-less" blade change system
- Uses Tang shank blades

4351FCT Includes: (2) 4-1/8" 9TPI Jig Saw Blade (792529-7-1), (2) Jig Saw Blade, T Shank, HCS, 4-1/8" x 9TPI (792729-9-1), (2) Jig Saw Blade, T Shank, HSS, 3" x 24TPI (792473-8-1), Anti-Splintering Insert (415524-7), Cover Plate (417852-6), Hex Wrench (783202-0), Tool Case (824809-4)

Length of Stroke	1"
Max. Cutting Capacity at 90° (wood)	5-5/16"
Max. Cutting Capacity at 90° (steel)	3/8"
Max. Cutting Capacity at 90° (aluminum)	25/32"
Strokes Per Minute (variable speed)	800 - 2,800 SPM
Blade Shank	"T" Tang
AMPS	6.3
Overall Length	10-3/4"
Net Weight	5.5 lbs.
Shipping Weight	9.2 lbs.



LXT BRUSHLESS

XVJ01Z

18V LXT® Brushless Barrel Grip Jig Saw

- Makita-built brushless motor and 3 orbital settings plus straight cutting deliver faster and more accurate cuts in a variety of materials
- Variable 6-speed control dial (800-3,500 SPM) enables user to match the speed to the application
- "Tool-less" blade change system allows for faster blade installation and removal for increased productivity
- Dual L.E.D. lights illuminate the work area
- Dual ambidextrous On/Off button with separate lock button
- Built-in dust blower clears the line of cut for increased accuracy

XVJ01Z Includes: Tool only, battery & charger not included Anti-Splintering Insert (415524-7), Cover Plate (417852-6), Hex Wrench (783202-0), Jig Saw Blade

Max. Cutting Capacity at 90° (wood)	5-5/16"
Max. Cutting Capacity at 90° (mild steel)	3/8"
Max. Cutting Capacity at 90° (aluminum)	25/32"
Strokes Per Minute (variable speed)	800 - 3,500 SPM
Blade Shank	"T" Tang
Power Type	Cordless
Battery	18V LXT® Lithium-Ion
Overall Length	11-3/4"
Net Weight (with battery)	5.5 lbs.
Shipping Weight	5.12 lbs.





LS1219LX

12" Dual-Bevel Sliding Compound Miter Saw with Stand

- Includes a 33.7 lbs. durable compact folding stand with transport wheels and a side handle for easier job site portability
 - Stand material support extensions extend 100-1/2" and support up to 500 lbs.
 - Increased capacity for up to 8" crown molding (vertically nested), 6-3/4" baseboard (vertical), and 15" crosscuts at 90°
 - In-front bevel lock for convenient operation
 - Dual dust collection ports provide excellent dust extraction performance
 - Miters 0-60° left and right; bevels 0-48° left and right
- LS1219LX Includes:** 12" Dual-Bevel Sliding Compound Miter Saw (LS1219L), Compact Folding Miter Saw Stand (WST06), Vertical Vise (126617-2), Dust Bag (122852-0), Triangular Rule (762001-3), 12" x 1" 60T Micro-Polished Miter Saw Blade, Hex Wrench (781044-6)

Blade Diameter	12"
Arbor	1"
Max. Cutting Capacity (miter 90°)	3-5/8" x 15"
Max. Cutting Capacity (miter 45°, L/R)	3-5/8" x 10-1/2"
No Load Speed	3,200 RPM
Dimensions (LxWxH)	35-1/4" x 26-1/8" x 28-1/2"
Net Weight	65 lbs.
Shipping Weight	118 lbs.



LS1219L

12" Dual-Bevel Sliding Compound Miter Saw

- Unique 2-Steel Rail Sliding System design allows operation flush against a wall
 - Increased capacity for up to 8" crown molding (vertically nested), 6-3/4" baseboard (vertical), and 15" crosscuts at 90°
 - In-front bevel lock for convenient operation
 - Electronic speed control maintains constant speed under load for smoother, higher quality cutting
 - Dual dust collection ports provide excellent dust extraction performance
 - Large-sized aluminum base improves stability of material for efficient cutting
- LS1219L Includes:** Dust Bag (122852-0), Triangular Rule (762001-3), Vertical Vise (126617-2), 12" x 1" 60T Micro-Polished Miter Saw Blade, Hex Wrench (781044-6)

Blade Diameter	12"
Arbor	1"
Max. Cutting Capacity (miter 90°)	3-5/8" x 15"
Max. Cutting Capacity (miter 45°, L/R)	3-5/8" x 10-1/2"
No Load Speed	3,200 RPM
Dimensions (LxWxH)	35-1/4" x 26-1/8" x 28-1/2"
Net Weight	65 lbs.
Shipping Weight	81.6 lbs.



LS1019LX

10" Dual-Bevel Sliding Compound Miter Saw with Stand

- Includes a 33.7 lbs. durable compact folding stand with transport wheels and a side handle for easier job site portability
 - Stand material support extensions extend 100-1/2" and support up to 500 lbs.
 - Increased capacity for up to 6-5/8" crown molding (vertically nested), 5-1/4" baseboard (vertical), and 12" crosscuts at 90°
 - In-front bevel lock for convenient operation
 - Dual dust collection ports provide excellent dust extraction performance
 - Miters 0-60° left and right; bevels 0-48° left and right
- LS1019LX Includes:** 10" Dual-Bevel Sliding Compound Miter Saw (LS1019L), Compact Folding Miter Saw Stand (WST06), Vertical Vise (122854-6), Dust Bag (122852-0), Triangular Rule (762001-3), 10" x 5/8" 60T Micro-Polished Miter Saw Blade, Hex Wrench (781044-6)

Blade Diameter	10"
Arbor	5/8"
Max. Cutting Capacity (miter 90°)	2-13/16" x 12"
Max. Cutting Capacity (miter 45°, L/R)	2-13/16" x 8-1/2"
No Load Speed	3,200 RPM
Dimensions (LxWxH)	31-3/4" x 25-3/8" x 26"
Net Weight	57.9 lbs.
Shipping Weight	114 lbs.



LS1019L

10" Dual-Bevel Sliding Compound Miter Saw

- Unique 2-Steel Rail Sliding System design allows operation flush against a wall
 - Increased capacity for up to 6-5/8" crown molding (vertically nested), 5-1/4" baseboard (vertical), and 12" crosscuts at 90°
 - In-front bevel lock for convenient operation
 - Electronic speed control maintains constant speed under load for smoother, higher quality cutting
 - Dual dust collection ports provide excellent dust extraction performance
 - Large-sized aluminum base improves stability of material for efficient cutting
- LS1019L Includes:** Vertical Vise (122854-6), Dust Bag (122852-0), Triangular Rule (762001-3), 10" x 5/8" 60T Micro-Polished Miter Saw Blade, Hex Wrench (781044-6)

Blade Diameter	10"
Arbor	5/8"
Max. Cutting Capacity (miter 90°)	2-13/16" x 12"
Max. Cutting Capacity (miter 45°, L/R)	2-13/16" x 8-1/2"
No Load Speed	3,200 RPM
Dimensions (LxWxH)	31-3/4" x 25-3/8" x 26"
Net Weight	57.9 lbs.
Shipping Weight	72.765 lbs.

LARGE CUTTING CAPACITY

CAPACITY
Cuts up to 6-5/8" crown (nested), 5-1/4" base (vertical), and crosscuts a 4x12 at 90°

PRODUCTIVITY
X2 LXT® technology delivers up to 334 cuts per charge in 2x4 SPF lumber using two 5.0Ah batteries



XSL04PTU

18V X2 LXT® (36V) Brushless 10" Dual-Bevel Sliding Compound Miter Saw Kit, AWS™

- Auto-Start Wireless System (AWS™) utilizes Bluetooth® technology for wireless power-on/off communication between tool and optional dust extractor
- X2 LXT® technology delivers up to 334 cuts in 2x4 SPF and 192 cuts in 2x12 SPF lumber per charge using two 5.0Ah batteries
- Unique 2-Steel Rail Sliding System allows operation flush against a wall
- In-front bevel lock for convenient operation
- Increased capacity for up to 6-5/8" crown molding (vertically nested), 5-1/4" baseboard (vertical), and 12" crosscuts at 90°
- Dual dust collection ports provide excellent dust extraction performance
- Miters 0-60° left and right; bevels 0-48° left and right



XSL04PTU Includes: 18V X2 LXT® (36V) Brushless 10" Dual-Bevel Sliding Compound Miter Saw, AWS™ (XSL04ZU), (2) 18V LXT™ Lithium-Ion 5.0Ah Battery (BL1850B), 18V LXT™ Lithium-Ion Dual Port Charger (DC18RD), Auto-Start Wireless Transmitter (198901-5), Vertical Vise (122854-6), Dust Bag (122852-0), Triangular Rule (762001-3), Hex Wrench, 10" x 5/8" 40T Micro-Polished Miter Saw Blade

XSL04ZU Includes: Tool only, battery & charger not included
Vertical Vise (122854-6), Dust Bag (122852-0), Triangular Rule (762001-3), Hex Wrench, 10" x 5/8" 40T Micro-Polished Miter Saw Blade, Wireless Unit

Blade Diameter	10"
Arbor	5/8"
Max. Cutting Capacity (miter 90°)	2-13/16" x 12"
Max. Cutting Capacity (miter 45°, L/R)	2-13/16" x 8-1/2"
No Load Speed	4,400 RPM
Battery	2X 18V LXT® Lithium-Ion
Dimensions (LxWxH)	31-3/4" x 25-3/8" x 26"
Net Weight (with battery)	60.2 lbs.
Automatic-start Wireless System (AWS™)	Yes (Transmitter Included)
Shipping Weight	86 lbs.



XSL06PT

18V X2 LXT® (36V) Brushless 10" Dual-Bevel Sliding Compound Miter Saw Kit

- X2 LXT® technology delivers up to 334 cuts per charge in 2x4 SPF and up to 192 cuts per charge in 2x12 SPF lumber using two 5.0Ah batteries
- Unique 2-Steel Rail Sliding System design allows operation flush against a wall
- In-front bevel lock for convenient operation
- Increased capacity for up to 6-5/8" crown molding (vertically nested), 5-1/4" baseboard (vertical), and 12" crosscuts at 90°

XSL06PT Includes: 18V X2 LXT® (36V) Brushless 10" Dual-Bevel Sliding Compound Miter Saw (XSL06Z), (2) 18V LXT™ Lithium-Ion 5.0Ah Battery (BL1850B), 18V LXT™ Lithium-Ion Dual Port Charger (DC18RD), Vertical Vise (122854-6), Dust Bag (122852-0), Triangular Rule (762001-3), Hex Wrench, XSL06 (781044-6), 10" x 5/8" 40T Micro-Polished Miter Saw Blade

XSL06Z Includes: Tool only, battery & charger not included
Vertical Vise (122854-6), Dust Bag (122852-0), Triangular Rule (762001-3), Hex Wrench, 10" x 5/8" 40T Micro-Polished Miter Saw Blade

Blade Diameter	10"
Arbor	5/8"
Max. Cutting Capacity (miter 90°)	2-13/16" x 12"
Max. Cutting Capacity (miter 45°, L/R)	2-13/16" x 8-1/2"
No Load Speed	4,400 RPM
Battery	2X 18V LXT® Lithium-Ion
Dimensions (LxWxH)	31-3/4" x 25-3/8" x 26"
Net Weight (with battery)	60.2 lbs.
Shipping Weight	80.483 lbs.



LS1018

10" Dual Slide Compound Miter Saw

- Powerful 13.0 AMP direct drive motor requires less maintenance and delivers 4,300 RPM
- Miters 0° - 47° left and 0° - 60° right, with positive stops at 0°, 15°, 22.5°, 31.6°, 45° (left and right)
- Linear ball bearing system engineered to deliver "dead-on" accurate cuts
- Less weight (43.7 lbs.) and compact design for job site portability
- Rear handle bevel lock is easily accessible and adjusts 0 - 45° (left and right) with positive stops at 0° and 45° (left and right)

LS1018 Includes: 10" 40T Miter Saw Blade (JM23000176), Vertical Vise (JM23100502), Extension Wing (JM23100500), Dust Bag (JM23100501), Socket Wrench (JM23100197), Triangle Rule (JM27000328)

Blade Diameter	10"
Arbor	5/8"
Max. Cutting Capacity (miter 90°)	3-5/8" x 12"
Max. Cutting Capacity (miter 45°, L/R)	3-5/8" x 8-1/2"
No Load Speed	4,300 RPM
AMPS	13
Dimensions (LxWxH)	21-1/8" x 32-1/2" x 25"
Net Weight	43.7 lbs.
Shipping Weight	51.7 lbs.



LS0815F

8-1/2" Slide Compound Miter Saw

- Powerful 10.5 AMP direct drive motor requires less maintenance and delivers 5,000 RPM
- Cuts up to 12" at 90° and 8-1/2" at 45°
- Miter 0°- 50° left and 0°- 60° right, with positive stops at 0°, 15°, 22.5°, 31.6°, 45° (right or left)
- Compact and lightweight (31.1 lbs.) for job site portability
- Linear ball bearing system engineered to deliver "dead-on" accurate cuts
- Dual rear handle bevel lock is easily accessible and adjusts 0°- 48° (left) and 0°- 5° (right) with positive stops at 0° and 45° (left)
- Soft start feature for smooth start-ups
- Built-in L.E.D. light illuminates the line of cut for increased accuracy

LS0815F Includes: 8-1/2" 48T Carbide-Tipped Miter Saw Blade (A-95934), Triangle Rule (JM27000328), Vertical Vise (JM23510009), Dust Bag, LS0815F (JM23510010), Box Wrench, LS0815F (782230-2), (2) Extension Wing (JM23000127)

Blade Diameter	8-1/2"
Arbor	5/8"
Max. Cutting Capacity (miter 90°)	2-9/16" x 12"
Max. Cutting Capacity (miter 45°, L/R)	2-9/16" x 8-1/2"
No Load Speed	5,000 RPM
AMPS	10.5
Dimensions (LxWxH)	29-3/4" x 17-3/4" x 19-1/4"
Net Weight	31.1 lbs.
Shipping Weight	41.8 lbs.



XSL02Z

18V X2 LXT® (36V) Brushless 7-1/2" Dual Slide Compound Miter Saw

- Weighs only 28.2 lbs. with battery (battery not included) for easy portability
- The electronically-controlled BL™ Brushless Motor efficiently uses energy to match torque and RPM to the changing demands of the application
- Soft start suppresses start-up reaction for smooth start-ups and longer gear life
- Miters 0-47° left and 0-57° right; bevels 0-45° left and 0-5° right
- Positive miter stops at: 0°, 15°, 22.5°, 30° and 45° left and right
- Linear ball bearing system engineered to deliver "dead-on" accurate cuts

XSL02Z Includes: Tool only, battery & charger not included 7-1/2" 40T Carbide-Tipped Miter Saw Blade (A-90629), Dust Bag (122852-0), Vertical Vise (122571-8), (2) Extension Wing (322312-4)

Blade Diameter	7-1/2"
Arbor	5/8"
Max. Cutting Capacity (miter 90°)	2-1/16" x 11-3/4"
Max. Cutting Capacity (miter 45°, L/R)	2-1/16" x 8-3/8"
No Load Speed	5,700 RPM
Battery	2X 18V LXT® Lithium-Ion
Dimensions (LxWxH)	25-3/4" x 17" x 17-1/2"
Net Weight (with battery)	28.9 lbs.
Shipping Weight	38 lbs.



XSL05Z

18V LXT® Brushless 6-1/2" Compact Dual-Bevel Compound Miter Saw

- Weighs only 14.6 lbs. with battery (battery not included) for easy portability
- 18V LXT® Lithium-Ion Battery delivers the power and performance of a corded miter saw without leaving the 18V LXT® platform (battery not included)
- High power provides efficient cutting in wood and aluminum extrusion (aluminum blade and cutting lubricant sold separately)
- LXT® technology delivers up to 270 cuts per charge in 1/2" x 3-1/2" baseboard using one 6.0Ah battery (battery not included)
- Automatic Speed Change™ technology adjusts cutting speed and torque during cut for optimum performance

XSL05Z Includes: Tool only, battery & charger not included Triangular Rule (762001-3), Dust Bag (122852-0), 6-1/2" x 5/8" 64T Micro-Polished Miter Saw Blade, Vertical Vise, Hex Wrench

Blade Diameter	6-1/2"
Arbor	5/8"
Max. Cutting Capacity (miter 90°)	1-13/16" x 3-5/8"
Max. Cutting Capacity (miter 45°, L/R)	1-13/16" x 2-9/16"
No Load Speed	5,000 RPM
Battery	18V LXT® Lithium-Ion
Dimensions (LxWxH)	13-3/8" x 15-3/4" x 17-1/4"
Net Weight (with battery)	14.6 lbs.
Shipping Weight	20.3 lbs.



LS1221

12" Compound Miter Saw

- Large cutting capacity (3-7/8" x 6" at 90°)
- 4-1/2" tall pivoting fence for cutting up to 5-1/2" crown molding
- Powerful 15 AMP direct drive motor delivers 4,000 RPM for smooth performance
- Positive stops at 9 settings; 15°, 22.5°, 31.6°, 45° right or left and 0°
- Horizontal D-handle design for easy and comfortable operation
- Electric brake for maximum productivity

LS1221 Includes: 12" 40T Micro-Polished Miter Saw Blade (A-93706), Vertical Vise (122540-9), Extension Wing (323726-0), Socket Wrench (782232-8), Dust Bag (122852-0)

Blade Diameter	12"
Arbor	5/8"
Max. Cutting Capacity (miter 90°)	3-7/8" x 6"
Max. Cutting Capacity (miter 45°, L/R)	2-3/4" x 5-7/8"
No Load Speed	4,000 RPM
AMPS	15
Dimensions (LxWxH)	24" x 26-1/2" x 23-7/8"
Net Weight	37 lbs.
Shipping Weight	50 lbs.

JOBSITE MITER SAW STANDS



LS1040

10" Compound Miter Saw

- Powerful 15 AMP direct drive motor for improved performance
- Dual post compound pivoting arm; bevel cuts up to 45° to the left
- Weighs only 27.3 lbs. for easy portability
- Positive stops at 9 settings: 15°, 22.5°, 30°, 45° right or left & 0° (90° cuts)
- Miter cuts 0 - 45° left and 0 - 52° right

LS1040 Includes: 10" 40T Micro-Polished Miter Saw Blade (A-93669), Dust Bag (122852-0), Triangular Rule (762001-3), Vertical Vise (122536-0), Socket Wrench (782232-8)

Blade Diameter	10"
Arbor	5/8"
Max. Cutting Capacity (miter 90°)	2-3/4" x 5-1/8"
Max. Cutting Capacity (miter 45°, L/R)	1-3/8" x 3-5/8"
No Load Speed	4,600 RPM
AMPS	15
Dimensions (LxWxH)	20-7/8" x 18-3/4" x 21"
Net Weight	27.3 lbs.
Shipping Weight	33 lbs.



WST06

Compact Folding Miter Saw Stand

- Compact and lightweight aluminum tubular design for job site portability; weighs only 33.7 lbs.
- Large solid rubber wheels and side handle allow the stand with miter saw attached to be easily moved around the job site (miter saw not included)
- Material support extensions extend to 100-1/2" and support up to 500 lbs. for increased cutting efficiency
- "Tool-less" adjustable miter saw bracket levers for easier installation/adjustment/removal of saw
- Durable aluminum feed roller and adjustable material stop are engineered for efficient repetitive cuts
- Adjustable non-marring rubberized foot provides additional support when leveling the stand on uneven surfaces

Table Height Positions (Adjustable)	1
Spring Loading Mechanism	No
Material Support Extensions (L)	100-1/2"
In-Feed Roller	Yes
Material Stop	Yes
Max. Weight Capacity	500 lbs.
Folded Dimensions (LxWxH)	50" x 10-3/4" x 9-3/4"
Open Dimensions (LxWxH)	56" x 29-1/2" x 33-1/2"
Net Weight	33.7 lbs.
Shipping Weight	42 lbs.



WST05

Portable Rise Miter Saw Stand

- Durable duty aluminum feed roller and adjustable material stop engineered for increased speed on repetitive cuts
- Material support extensions extend up to 106-1/2" with a maximum supported weight of 220 lbs. for increased cutting efficiency
- 2-Position adjustable stand provides 21-5/8" and 31-1/2" heights for increased comfort
- Spring-loaded mechanism engineered for quick and easy jobsite set up
- Compact design (46" folded) for convenient transportation to and from the job site, and easy vertical or horizontal storage
- Adjustable non-marring rubberized feet provide additional support when leveling stand on uneven surfaces
- "Tool-less" adjustable miter saw bracket holders for easier installation/removal of saw

Table Height Positions (Adjustable)	2
Spring Loading Mechanism	Yes
Material Support Extensions (L)	106-1/2"
In-Feed Roller	Yes
Material Stop	Yes
Max. Weight Capacity	220 lbs.
Folded Dimensions (LxWxH)	46" x 19-3/4" x 15-3/4"
Open Dimensions (LxWxH)	46" x 19-3/4" x 31-1/2"
Net Weight	58 lbs.
Shipping Weight	66 lbs.



WST01N

Large Rising Base Miter Saw Stand

- Large platform base for additional work space
- 5-position adjustable stand offers a 26", 27-3/4", 29-7/8", 31-1/4", or 33" height position
- Spring loaded mechanism for quick and easy set ups
- Durable duty 12-1/8" wide aluminum feed roller and adjustable material stop engineered for increased efficiency on repetitive cuts
- Material support extensions extend up to 108" (9') with a maximum supported weight of 220 lbs. for increased cutting efficiency
- Solid rubber 12" wheels for easy portability, job to job
- Portability and adjustment features are ideal for a range of cutting applications (miter saw not included)
- Fits all currently available Makita miter saws

Table Height Positions (Adjustable)	5
Spring Loading Mechanism	Yes
Material Support Extensions (L)	108"
In-Feed Roller	Yes
Material Stop	Yes
Max. Weight Capacity	220 lbs.
Folded Dimensions (LxWxH)	50-1/2" x 21-1/2" x 15-3/4"
Open Dimensions (LxWxH)	50-1/2" x 21-1/2" x 33"
Net Weight	79 lbs.
Shipping Weight	90.7 lbs.

NEW

Carbide-Tipped Max Efficiency

Introducing the next generation of accessories, MAX Efficiency. This new line of products is engineered to deliver optimal and efficient corded and cordless cutting solutions. Increased efficiency in cutting or drilling applications allows for more cuts or holes per charge when paired with cordless tools. Makita's MAX Efficiency line of products provide the user with industry leading performance and durability.

Reduced swing width allows for smoother material removal with less cutting resistance

Ultra-thin 0.057" kerf reduces the load put on the tool

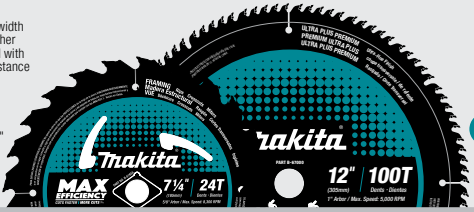

Premium Ultra-Coated

Alternate Top ATAF
Alternate Face

ATAF (Alternate Top and Alternating Face) tooth design for ultra precision cutting



Japanese ultra-thin kerf carbide-tipped design provide smoother cuts without drag on the motor and minimal material loss



Plate Thickness



Hook Angle

Fully hardened and expertly hand-tensioned steel saw plates for true cuts



QUIET CUTTING

Resin Bond Filled Laser Cut Slots

Ultra-coated blades feature resin bond filled laser cut slots for quiet and smooth cutting

ULTRA-COATED

Ultra-coated blades provide reduced pitch build-up

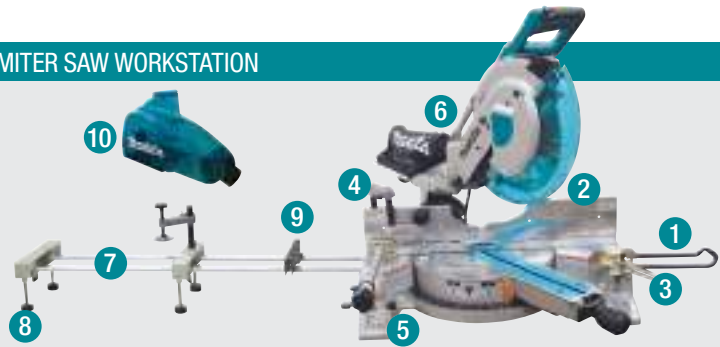

Description	Model	Part #
1 Extension Wing	LS1013F/FL, LS1214F/FL	322932-4
	LS1036, LS1011	192118-2
	LS0714, LS1040	322312-4
	LS1221	323726-0
	LS1016/L/LX5, LS1216L/LX4	325673-1 ¹
2 Right Sub-Fence	LS1019L/X, XSL04ZU, XSL06Z/PT	326978-2
	LS0815F	JM23000127
3 Crown Molding Stopper Set	LS1013F/FL, LS1214F/FL	153898-5
	LS1013F/FL	192628-9
	LS1040	192622-1
4 Vertical Vise	LS1016/L/LX5, LS1221	192669-5
	LS1216L/LX4	195253-5
	LS1040	122536-0
	LS1013F/FL	122538-6
5 Horizontal Vise	LS1221	192672-6
	LS1214F/FL	122540-9
	LS0714	122571-8
	LS1016/L/LX5, LS1216L/LX4	122854-6
	LS1019L/X, XSL04ZU, XSL06Z/PT	126617-2
6 Directional Elbow	LS1040, LS1013F/FL, LS1221, LS1214F/FL	416368-8
	LS1016/L/LX5, LS1216L/LX4	122930-6
7 Extension Rod 1/2" x 83"	LS1040, LS1221, LS1214F/FL	256812-1
8 Extension Rod Holder	LS1040	122446-1
	LS1214F/FL, LS1221	192671-8
9 Repetitive Cut Set Plate	LS1040, LS0714, LS1221	122472-0
10 Dust Box	LS1016/L/LX5, LS1216L/LX4, LS0714, LXSL01	194175-6

¹ Use with thumbscrew Part # 251889-1

SEE MORE // pg.149



Internation Lok

2012NB

12" Portable Planer

- Compact with less weight for easy transporting to the jobsite
- Engineered for faster, easier blade changes
- Low noise (83dB) for operator comfort
- 4-post design and diagonal cross supports for stability
- Large and easy-to-operate on/off paddle switch
- Fully adjustable depth stop for repeat cuts

2012NB Includes: 12" Planer Blade, 2/pk (793346-8), Magnetic Holder (762014-4), Blade Wrench (783208-8), Key (415715-0)

Cutting Capacity (width)	12"
Cutting Capacity (depth)	1/8"
Cutting Capacity (thickness)	6-3/32"
No. of Knives	2
Table Size (WxL)	12" x 30-3/8"
No Load Speed	8,500 RPM
AMPS	15
Dimensions (LxWxH)	30-3/8" x 19-1/64" x 15-25/32"
Net Weight	61.9 lbs.
Shipping Weight	67.6 lbs.



(BRAKE)

2705X1

10" Table Saw with Stand

- Powerful 15.0 AMP motor delivers 4,800 RPM for improved performance
- Large cutting capacity (3-9/16" at 90° and 2-1/2" at 45°); rips 4x material in one pass
- Large 25" ripping capacity for cutting plywood/sheet material
- Easy to read scale with magnifying glass for increased accuracy
- Includes portable table saw stand with spring loaded mechanism for quick and easy set up

2705X1 Includes: 10" 32T Carbide-Tipped Table Saw Blade (A-94948), Rip Fence (122740-1), Miter Gauge (122838-4), Push Stick (416772-1), Spanner Wrench (781038-1), Wrench (782024-5), Hex Wrench (783203-8), Portable Table Saw Stand (194093-8)

Blade Diameter	10"
Arbor	5/8"
Max. Cutting Capacity (at 90°)	3-5/8"
Max. Cutting Capacity (at 45°)	2-1/2"
No Load Speed	4,800 RPM
AMPS	15
Table Size (WxL)	24-5/8" x 22-1/4"
Net Weight	114.7 lbs.
Shipping Weight	171 lbs.



(BRAKE)

2705

10" Table Saw

- Powerful 15 AMP motor delivers 4,800 RPM for improved performance
- Large cutting capacity (3-9/16" at 90° and 2-1/2" at 45°) can rip 4x material in one pass; can use up to a 13/16" dado blade
- Right extension table allows for greater cutting capacity with the capability to rip 4x8 sheets of plywood
- Extended capacity with up to 25" ripping
- "Tool-less" modular blade guard system with an adjustable riving knife/spreader

2705 Includes: 10" 32T Carbide-Tipped Table Saw Blade (A-94948), Rip Fence (122740-1), Miter Gauge (122838-4), Push Stick (416772-1), Spanner Wrench (781038-1), Wrench (782024-5), Wrench 5 (783224-8)

Blade Diameter	10"
Arbor	5/8"
Max. Cutting Capacity (at 90°)	3-5/8"
Max. Cutting Capacity (at 45°)	2-1/2"
No Load Speed	4,800 RPM
AMPS	15
Table Size (WxL)	24-5/8" x 22-1/4"
Net Weight	65.5 lbs.
Shipping Weight	82 lbs.

TABLE SAW ACCESSORIES

194093-8
Portable Table Saw Stand

- Fully adjustable with pressure-assisted cylinders on both sides
- Hard rubber wheels will not go flat
- Thick steel frame engineered to maintain rigidity



Rubberized Handle

Heavy-Duty Design

Large Wheels

Description	Model	Part #
Porta-Table	2703	122731-A
Table Saw Stand	2703	193920-6
Blade Guard System	2705/X1	122820-3
Outfeed Table Set	2704, 2705/X1	194087-3
Dado Flange Set	2703, 2704	192693-8
Dado Head Insert	2703, 2704, 2705/X1	317061-6 317934-3
Push Stick	2703, 2704, 2705/X1	416772-1
Push Block	2703, 2704, 2705/X1	155508-0
Miter Gauge	2703, 2704, 2705/X1	122555-6 122838-4





TM3010CX1

Multi-Tool Kit

- Powerful 3.0 AMP motor with soft start feature for smooth start-ups and improved performance for fast cutting, sanding, scraping and grout removal
- Variable speed control dial (6,000-20,000 OPM) enables user to match the speed to the application
- Electronic speed control maintains constant speed under load for smoother, higher-quality work
- Precision engineered for reduced vibration (6.5m/s²) and low noise 80dB(A)
- 3.2° oscillation angle engineered for faster cutting and sanding
- Small diameter barrel grip for improved handling and added operator comfort

TM3010CX1 Includes: 1-1/4" Plunge Blade (BIM), 14TPI (A-95255), Sanding Pad, Multi-Tool, TM3000C, LXMT (A-95423), (5) 120 Grit Sandpaper (A-95532-1), (5) 180 Grit Sandpaper (A-95548-1), Multi-Tool Adapter (313249-6), Multi-Tool Adapter (196271-6), Accessory Case, Tool Case

Oscillations Per Minute	6,000 - 20,000 OPM
Oscillation Angle	3.2°
AMPS	3
Overall Length	11-1/8"
Net Weight	3.5 lbs.
Shipping Weight	8.8 lbs.



LXT

XMT035

XMT03Z

18V LXT® Multi-Tool Kit

- 18V LXT® Lithium-Ion battery provides up to 20 minutes of continuous run time
- Variable speed control dial (6,000-20,000 OPM) enables user to match the speed to the application
- 3.2° oscillation angle engineered for faster, more aggressive cutting and sanding
- Large on/off slide switch with lock-on button for operator convenience
- Includes adapters to fit most competitive accessories
- Small diameter barrel grip (only 2-3/8") for easy handling

XMT035 Includes: 18V LXT® Multi-Tool (XMT03Z), (2) 18V LXT® Lithium-Ion 3.0Ah Battery (BL1830B), 18V LXT® Lithium-Ion Rapid Optimum Charger (DC18RC), 1-1/4" Plunge Blade (BIM), 14TPI (A-95255), Multi-Tool Adapter (313249-6), Multi-Tool Adapter (196271-6), Sanding Pad, Multi-Tool, TM3000C, LXMT (A-95423), 120 Grit Sandpaper (A-95532-1), 180 Grit Sandpaper (A-95548-1), Tool Case

XMT03Z Includes: Tool only, battery & charger not included 1-1/4" Plunge Blade (BIM), 14TPI (A-95255), Multi-Tool Adapter (313249-6), Multi-Tool Adapter (196271-6)

Oscillations Per Minute	6,000 - 20,000 OPM
Oscillation Angle	3.2°
Battery	18V LXT® Lithium-Ion
Overall Length	13-3/8"
Net Weight (with battery)	4.9 lbs.
Shipping Weight	14.33 lbs.



MULTI-TOOL ACCESSORIES

A-95342 2" Scraper (HCS)



A-95277 1-1/4" Plunge Blade (HCS), 18TPI



A-95401 3" Scraping Plate, Tungsten Carbide



A-95227 3-1/4" Segmented Saw Blade



A-95168 3-1/4" Round Saw Blade, BiM-TiN



A-95386 3-1/4" Grout Removal Blade, Tungsten Carbide



A-95386 3-1/4" Grout Removal Blade, Tungsten Carbide



Sandpaper

• 10 per/pkg



Description	Part #
Assortment	A-95853
180 Grit	A-95548
150 Grit	A-95750
120 Grit	A-95532
100 Grit	A-95744
80 Grit	A-95526

SEE MORE // pg.155



RP2301FC

3-1/4 HP* Plunge Router

- Powerful 15 AMP motor delivers 9,000 - 22,000 RPM for smooth routing
- Electronic speed control maintains constant speed under load
- Variable speed control dial enables user to match the speed to the application
- Soft start feature for smooth start-ups
- Electric brake for maximum productivity
- 0" - 2-3/4" plunge depth capacity for easy penetration in work piece

RP2301FC Includes: 1/2" Collet (763622-4), 1/4" Collet (763803-0), Extend Depth Adjustment Knob (158980-5), Spanner Wrench (781030-7)

Collet Capacity	1/2", 1/4"
Plunge Capacity	2-3/4"
No Load Speed (variable speed)	9,000 - 22,000 RPM
AMPS	15
Maximum Horsepower	3-1/4 HP
Overall Length	12-1/4"
Net Weight	13.4 lbs.
Shipping Weight	16.4 lbs.



RP1800

3-1/4 HP* Plunge Router

- Powerful 15 AMP motor delivers up to 22,000 RPM for smooth routing
- 0" - 2-3/4" plunge depth capacity for easy penetration in work piece
- Linear ball bearings for smooth plunge action and superior performance
- Quick release plunge depth adjustment with micro control along with 3 preset depth stops for added precision
- Oversized ball bearing construction for longer tool life
- Ergonomic rubberized handles with built-in large two-finger switch

RP1800 Includes: 1/2" Collet (763622-4), 1/4" Collet (763803-0), Extend Depth Adjustment Knob (158980-5), Spanner Wrench (781030-7)

Collet Capacity	1/2", 1/4"
Plunge Capacity	2-3/4"
No Load Speed	22,000 RPM
AMPS	15
Maximum Horsepower	3-1/4 HP
Overall Length	12-1/4"
Net Weight	13.4 lbs.
Shipping Weight	16.4 lbs.



RP0900K

1-1/4 HP* Plunge Router

- 0" - 1-3/8" plunge depth capacity for easy penetration into work piece
- Plunge depth adjustment lever with 3 preset depth stops for precision
- Oversized ball bearing construction for longer tool life
- Durable flat top design for added convenience when changing bits
- Rubberized contoured handles with built-in switch for better fit & control
- Easy-to-read depth scales

RP0900K Includes: 1/4" Collet (763837-1), Straight Guide (164834-6), Spanner Wrench (781006-4), Spanner Wrench (781011-1), Tool Case (824880-8)

Collet	1/4"
Plunge Capacity	1-3/8"
No Load Speed	27,000 RPM
AMPS	8
Maximum Horsepower	1-1/4 HP
Overall Length	8-1/2"
Net Weight	6 lbs.
Shipping Weight	5.52 lbs.



RF1101KIT2

2-1/4 HP* Router Kit, with Plunge Base

- Powerful 11 AMP motor with variable speed control dial
- Electronic speed control with soft start feature
- Rugged aluminum motor housing with small 3-1/4" diameter
- Cam-lock for fast and easy depth adjustment and removal of motor
- Conveniently located plunge lock lever for efficient operation

RF1101KIT2 Includes: 2-1/4 HP* Router (RF1101), Plunge Base (193457-3), 1/2" Collet (763643-6), 1/4" Collet with Nut (193214-9), 2-1/2" Clear Sub Base (193155-9), (2) Wrench 27 (193234-3), Spanner Wrench (781213-9), Hex Wrench (783202-0), Tool Case (824648-2)

Collet Capacity	1/2", 1/4"
Plunge Capacity	2-19/32"
No Load Speed (variable speed)	8,000 - 24,000 RPM
AMPS	11
Maximum Horsepower	2-1/4 HP
Overall Length	8-3/4"
Net Weight	7.2 lbs.
Shipping Weight	20 lbs.



RF1101

2-1/4 HP* Router

- Variable speed control dial to match the speed to the application
- Electronic speed control maintains constant speed under load
- Soft start feature for smooth start-ups
- Rugged aluminum motor housing with small 3-1/4" diameter
- Sub-base accepts industry standard template guides
- Durable flat top for stability when changing bits

RF1101 Includes: 1/2" Collet (763643-6), 1/4" Collet with Nut (193214-9), Wrench 27 (193234-3)

Collet Capacity	1/2", 1/4"
No Load Speed (variable speed)	8,000 - 24,000 RPM
AMPS	11
Maximum Horsepower	2-1/4 HP
Overall Length	8-3/4"
Net Weight	7.2 lbs.
Shipping Weight	10 lbs.

*Maximum horsepower



RD1101

2-1/4 HP* Router

- Electronic speed control maintains constant speed under load
- Soft start feature for smooth start-ups
- Rugged aluminum motor housing with small 3-1/4" diameter
- Sub-base accepts industry standard template guides
- Industrial cam-lock for fast and easy depth adjustment and removal of motor

RD1101 Includes: 1/4" Collet with Nut (193214-9), 1/2" Collet (763643-6), Wrench 27 (193234-3)

Collet Capacity	1/2", 1/4"
No Load Speed (variable speed)	8,000 - 24,000 RPM
AMPS	11
Maximum Horsepower	2-1/4 HP
Overall Length	8-3/4"
Net Weight	7.9 lbs.
Shipping Weight	10.9 lbs.



RT0701CX3

1-1/4 HP* Compact Router Kit

- Variable speed control dial (10,000 - 30,000 RPM) to match the speed to the application
- Smooth rack-and-pinion fine depth adjustment system for more precise settings
- Accepts industry standard template guides
- Ideal for routing small profiles, dovetailing, door hinges and more
- 0" - 1-3/8" plunge depth capacity for easy penetration into workpiece
- Tilt base for routing at different angles (-30° to 45°)

RT0701CX3 Includes: 1-1/4 HP* Compact Router (RT0701C), 1/4" Collet (763637-1), Trimmer Base (196613-4), Plunge Base (196094-2), Tilt Base (198987-9), Offset Base (196093-4), Straight Guide (122965-7), Dust Extracting Attachment, Fixed Base (196559-1), Dust Extracting Attachment, Plunge Base (194733-8), Spanner Wrench (781039-9), Spanner Wrench (781011-1), Trimmer Guide (122703-7), Tool Bag

Collet	1/4"
Plunge Capacity	1-3/8"
No Load Speed (variable speed)	10,000 - 30,000 RPM
AMPS	6.5
Maximum Horsepower	1-1/4 HP
Overall Length	7-7/8"
Net Weight	3.9 lbs.
Shipping Weight	19.8 lbs.



RT0701CX7

1-1/4 HP* Compact Router Kit

- Variable speed control dial (10,000 - 30,000 RPM) enables user to match the speed to the application
- Smooth rack-and-pinion fine depth adjustment system for more precise settings
- Slim and ergonomically designed body for increased comfort and control
- Cam lock system for easy depth adjustments
- Kit includes fixed and plunge bases

RT0701CX7 Includes: 1-1/4 HP* Compact Router (RT0701C), 1/4" Collet (763637-1), Trimmer Base (196613-4), Plunge Base (196094-2), Straight Guide (122965-7), Spanner Wrench (781039-9), Spanner Wrench (781011-1)

Collet	1/4"
Plunge Capacity	1-3/8"
No Load Speed (variable speed)	10,000 - 30,000 RPM
AMPS	6.5
Maximum Horsepower	1-1/4 HP
Overall Length	7-7/8"
Net Weight	3.9 lbs.
Shipping Weight	10.5 lbs.



RT0701C

1-1/4 HP* Compact Router

- Variable speed control dial (10,000 - 30,000 RPM) to match the speed to the application
- Smooth rack-and-pinion fine depth adjustment system for more precise settings
- Slim and ergonomically designed body for increased comfort and control
- Accepts industry standard template guides
- Cam lock system for easy depth adjustments
- Electronic speed control maintains constant speed under load

RT0701C Includes: Trimmer Base (196613-4), 1/4" Collet (763637-1), Straight Guide (122965-7), Spanner Wrench (781039-9), Spanner Wrench (781011-1)

Collet	1/4"
No Load Speed (variable speed)	10,000 - 30,000 RPM
AMPS	6.5
Maximum Horsepower	1-1/4 HP
Overall Length	7-7/8"
Net Weight	3.9 lbs.
Shipping Weight	6.3 lbs.



LXT BRUSHLESS

XTR01T7

XTR01Z

18V LXT* Brushless Compact Router Kit

- LXT* technology delivers 380 feet of cutting performance in red oak using a 1/4" (6mm) straight bit at a 5/32" (4mm) depth with a 5.0Ah battery
- Variable speed control dial (10,000 - 30,000 RPM) to match the speed to the application
- Comes with a plunge base for added versatility, offering a plunge capacity of 0 - 1-3/8" (additional bases and attachments sold separately)

XTR01T7 Includes: 18V LXT* Brushless Compact Router (XTR01Z), (2) 18V LXT* Lithium-Ion 5.0Ah Battery (BL1850B), 18V LXT* Lithium-Ion Rapid Optimum Charger (DC18RC), Interlocking Case, X-Large (197213-3), Trimmer Base (196613-4), Plunge Base (196094-2), Straight Guide (122965-7), Spanner Wrench (781011-1), Spanner Wrench (781039-9), 1/4" Collet (763637-1), 3/8" Collet (763619-3), Template Guide (343577-5), Template Guide 5/8" (344364-5)

XTR01Z Includes: Tool only, battery & charger not included
Spanner Wrench (781011-1), Spanner Wrench (781039-9), 1/4" Collet (763637-1), 3/8" Collet (763619-3), Straight Guide (122965-7), Template Guide (343577-5)

Collet	1/4"
No Load Speed (variable speed)	10,000 - 30,000 RPM
Battery	18V LXT* Lithium-Ion
Overall Length	5-1/4"
Net Weight (with battery)	4.6 lbs.
Shipping Weight	20.1 lbs.



LXT BRUSHLESS

XTR01T8J

XTR01Z

18V LXT* Brushless Compact Router Starter Kit

- Starter Kit includes fixed base, straight guide, rapid charger, one battery and case
- LXT* technology delivers 380 feet of cutting performance in red oak using a 1/4" (6mm) straight bit at a 5/32" (4mm) depth with a 5.0Ah battery
- Makita-built brushless motor delivers faster and more accurate cuts in a variety of materials
- Variable speed control dial (10,000 - 30,000 RPM) to match the speed to the application

XTR01T8J Includes: 18V LXT* Brushless Compact Router (XTR01Z), 18V LXT* Lithium-Ion 5.0Ah Battery (BL1850B), 18V LXT* Lithium-Ion Rapid Optimum Charger (DC18RC), Interlocking Case, Large (197212-5), Trimmer Base (196613-4), Straight Guide (122965-7), Spanner Wrench (781011-1), Spanner Wrench (781039-9), 1/4" Collet (763637-1)

XTR01Z Includes: Tool only, battery & charger not included
Spanner Wrench (781011-1), Spanner Wrench (781039-9), 1/4" Collet (763637-1), 3/8" Collet (763619-3), Straight Guide (122965-7), Template Guide (343577-5)

Collet	1/4"
No Load Speed (variable speed)	10,000 - 30,000 RPM
Battery	18V LXT* Lithium-Ion
Overall Length	5-1/4"
Net Weight (with battery)	4.6 lbs.
Base	Fixed
Shipping Weight	15.28 lbs.



LXT BRUSHLESS

XTR01Z

18V LXT* Brushless Compact Router

- Delivers 380 feet of cutting performance in red oak using a 1/4" (6mm) straight bit at a 5/32" (4mm) depth with a 5.0Ah battery (battery not included)
- Variable speed control dial (10,000 - 30,000 RPM) to match the speed to the application
- Accepts industry standard template guides
- Smooth rack-and-pinion fine depth adjustment system for more precise settings
- Dual L.E.D. lights illuminate the work area
- Quick release cam lock system for convenient depth adjustments and base removal/installation

XTR01Z Includes: Spanner Wrench (781011-1), Spanner Wrench (781039-9), 1/4" Collet (763637-1), 3/8" Collet (763619-3), Straight Guide (122965-7), Template Guide (343577-5)

Collet	1/4"
No Load Speed (variable speed)	10,000 - 30,000 RPM
Battery	18V LXT* Lithium-Ion
Overall Length	5-1/4"
Net Weight (with battery)	4.6 lbs.
Shipping Weight	5.3 lbs.

COMPACT ROUTER ACCYS.

Plunge Base Assembly

Model	Part #
RT0700C, RT0701C, RT0700CX3, RT0701CX7, XTR01T7Z	196094-2

Tilt Base

Model	Part #
RT0700C, RT0701C, RT0700CX3, RT0701CX7, XTR01T7Z	198987-9

Offset Base

Model	Part #
RT0700C, RT0701C, RT0700CX3, RT0701CX7, XTR01T7Z	196093-4

Trimmer Base

Model	Part #
RT0700C, RT0701C, RT0700CX3, RT0701CX7, XTR01T7Z	196613-4

Fixed Base Handles

Model	Part #
RT0700C, RT0701C, RT0700CX3, RT0701CX7, XTR01T7Z	196924-7

Dust Nozzle

Model	Part #
RT0700C, RT0701C, RT0700CX3, RT0701CX7, XTR01T7Z	194733-8

Trimmer Guide

Model	Part #
RT0700C, RT0700CX3, RT0701C, RT0700CX3, RT0701CX7, XTR01T7Z	122703-7

*Maximum horsepower



3709

1/4" Fixed Base Laminate Trimmer

- 4.0 AMP motor delivers 30,000 RPM for smooth trimming and light routing applications
- Top-mounted power cord stays out of the way for easier operation
- Transparent base for a clear view of the trimming edge
- Slim design with rubberized grip for comfort and control
- Smooth rack-and-pinion fine depth adjustment
- Compact with less weight (3.3 lbs.)

3709 Includes: 1/4" Collet (763663-0), Template Guide (343577-5), Spanner Wrench (781036-5), Spanner Wrench (781037-3), Straight Bit 6 E (732328-9), Chip Deflector (418647-0), Trimmer Guide (122703-7)

Collet	1/4"
No Load Speed	30,000 RPM
AMPS	4
Overall Length	7-7/8"
Net Weight	3.3 lbs.
Shipping Weight	5.66 lbs.



B06050J

6" Random Orbit Sander

- Convenient 2-mode switch for "random orbit" and "random orbit with forced rotation" action
- Variable speed control dial (1,600 - 6,800 OPM) to match the speed to the application
- Ergonomically designed barrel grip and side handle for increased comfort
- 7/32" orbit diameter provides a swirl-free finish
- "Tool-less" backing pad change enables quick pad change to meet application
- Efficient through-the-pad dust collection system with built-in dust port for a cleaner work environment

B06050J Includes: 6" Round Abrasive Disc, Hook & Loop, 120 Grit (794610-0-1), 6" Round Sanding Backing Pad, Hook & Loop, Soft (197314-7), Dust Extracting Attachment (143326-8), Pad Protector (456127-8), Side Handle (153489-2), Interlocking Case, Large (197212-5)

Pad Size (round)	6"
Abrasive Disc Size	6"
Orbits Per Minute (variable speed)	1,600 - 6,800 OPM
Orbit Diameter	7/32"
AMPS	6.6
Vibration (m/s ²)	5
Dimensions (LxWxH)	13" x 6-1/8" x 5-3/4"
Net Weight	5.7 lbs.
Shipping Weight	12.4 lbs.



B06030

6" Random Orbit Sander

- Variable speed control dial (4,000-10,000 OPM) enables user to match the sanding speed to the application
- Efficient through-the-pad dust collection system with dust bag for a cleaner work environment
- Ergonomic rubberized rear handle reduces vibration for operator comfort
- Utilizes 6" hook-and-loop abrasive discs for fast and easy installation
- 1/8" orbit diameter provides a swirl-free finish
- Detachable front handle allows for sanding in corners and confined areas

B06030 Includes: 6" Round Abrasive Disc, Hook & Loop, 120 Grit (794610-0-1), Hex Wrench (783203-8), Dust Bag (151517-7), Dust Nozzle (151518-5), Wrench Holder (410047-0), Rubber Pad (193286-4)

Pad Size (round)	6"
Abrasive Disc Size	6"
Orbits Per Minute (variable speed)	4,000 - 10,000 OPM
Orbit Diameter	1/8"
AMPS	2.7
Vibration (m/s ²)	4
Dimensions (LxWxH)	12-1/8" x 5-7/8" x 7-1/8"
Net Weight	5.2 lbs.
Shipping Weight	6.9 lbs.



B05030 / B05030K

5" Random Orbit Sander

- Large 1/8" random orbit action for fast and super smooth sanding
- Pad control system for controlled pad speed up on start-up
- Efficient through-the-pad dust collection system
- Dust-sealed switch minimizes contamination
- Uses 5" (8-hole) hook-and-loop abrasive paper

B05030 Includes: Dust Bag (166078-4)

B05030K Includes: Dust Bag (166078-4), Plastic Tool Case (183782-0), Dust Bag Nozzle (416063-0)

Pad Size (round)	4-13/16"
Abrasive Disc Size	5"
Orbits Per Minute	12,000 OPM
Orbit Diameter	1/8"
AMPS	3
Vibration (m/s ²)	4.5
Dimensions (LxWxH)	6" x 4-7/8" x 6"
Net Weight	2.9 lbs.
Shipping Weight:	B05030 (3.75 lbs.), B05030K (6 lbs.)



B05031K

5" Random Orbit Sander, with Case

- Variable speed control dial (4,000 - 12,000 OPM) to match the speed to the application
- Large 1/8" random orbit action for faster and super smooth sanding
- Pad control system for controlled pad speed upon start-up
- Efficient through-the-pad dust collection system
- Dust-sealed switch minimizes contamination
- Uses quick-change 5" (8-Hole) hook-and-loop paper (abrasive paper sold separately)

B05031K Includes: Dust Bag (166078-4), Plastic Tool Case (183782-0)

Pad Size (round)	4-13/16"
Abrasive Disc Size	5"
Orbits Per Minute (variable speed)	4,000 - 12,000 OPM
Orbit Diameter	1/8"
AMPS	3
Vibration (m/s ²)	4
Dimensions (LxWxH)	6" x 4-7/8" x 6"
Net Weight	3 lbs.
Shipping Weight	7 lbs.



B05041 / B05041K

5" Random Orbit Sander, Variable Speed

- Smoother and faster sanding with 3.0 AMP motor
- Variable speed control dial (4,000-12,000 OPM) enables user to match the sanding speed to the application
- Ergonomic rubberized palm grip and handle for improved operator comfort and control
- Adjustable front handle allows for sanding in corners and confined areas
- Uses quick-change 5" (8-hole) hook-and-loop abrasive paper (abrasive paper sold separately)

B05041 Includes: Dust Bag (166078-4), Dust Bag Nozzle (416063-0), (416064-8)

B05041K Includes: Dust Bag (166078-4), Dust Bag Nozzle (416063-0), (416064-8), Tool Case

Pad Size (round)	4-13/16"
Abrasive Disc Size	5"
Orbits Per Minute (variable speed)	4,000 - 12,000 OPM
Orbit Diameter	1/8"
AMPS	3
Vibration (m/s ²)	3.5
Dimensions (LxWxH)	10-7/8" x 4-7/8" x 6"
Net Weight	3.5 lbs.
Shipping Weight:	B05041 (4.1 lbs.), B05041K (6.3 lbs.)



LXT

XOB01T

18V LXT® 5" Random Orbit Sander Kit

- Three speed settings (7,000/9,500/11,000 OPM) engineered for fast material removal
- Up to 65 minutes (low speed) and 32 minutes (high speed) of run time on a single charge
- Large 1/8" random orbit action engineered for faster sanding and swirl-free finish
- One-touch electronic speed control switch provides fast, medium and low settings
- Ergonomically designed body and grip for increased operator comfort
- Pad brake engineered for reduced free-spin and improved overall finish

XOB01T Includes: 18V LXT® Random Orbit Sander (XOB01Z), (2) 18V LXT® Lithium-Ion 5.0Ah Battery (BL1850B), 18V LXT® Lithium-Ion Rapid Optimum Charger (DC18RC), Dust Bag (166078-4), 5" Round Abrasive Disc, Hook & Loop, 120 Grit (794520-1-1), Tool Bag

Pad Size (round)	5"
Abrasive Disc Size	5"
Orbits Per Minute (3 speed)	7,000, 9,500, 11,000 OPM
Orbit Diameter	1/8"
Battery	18V LXT® Lithium-Ion
Vibration (m/s ²)	2.5
Dimensions (LxWxH)	6-7/8" x 4-7/8" x 6"
Net Weight (with battery)	3.6 lbs.
Shipping Weight	11.8 lbs.



B04556 / B04556K

1/4 Sheet Finishing Sander

- Precision engineered all-ball-bearing construction for reduced vibration and noise
- Contoured, rubberized palm grip design for operator comfort
- Large clamping lever for quick and easy paper installation
- Efficient through-the-pad dust collection system
- Conveniently located on/off switch for easy one-handed operation

B04556 Includes: 4-1/2" x 5-1/2" Abrasive Paper, 60 Grit (742509-3-1), 4-1/2" x 5-1/2" Abrasive Paper, 100 Grit (742510-8-1), 4-1/2" x 5-1/2" Abrasive Paper, 150 Grit (742511-6-1), Dust Bag (166078-4), Punch Plate (450066-4)

B04556K Includes: 4-1/2" x 5-1/2" Abrasive Paper, 60 Grit (742509-3-1), 4-1/2" x 5-1/2" Abrasive Paper, 100 Grit (742510-8-1), 4-1/2" x 5-1/2" Abrasive Paper, 150 Grit (742511-6-1), Dust Bag (166078-4), Punch Plate (450066-4), Tool Case

Pad Size	4-1/2" x 4"
Abrasive Paper Size	4-1/2" x 5-1/2"
Orbits Per Minute	14,000 OPM
AMPS	2
Vibration (m/s ²)	4
Dimensions (LxWxH)	5-1/8" x 4-3/8" x 5-9/16"
Net Weight	2.5 lbs.
Shipping Weight:	B04556 (3.7 lbs.), B04556K (7.15 lbs.)



B03710

1/3 Sheet Finishing Sander

- Ergonomic rubberized grip and handle designed for better fit and added comfort
- 11,000 OPM for Increased Efficiency and Smooth Finish Sanding
- Efficient through-the-pad dust collection system for a cleaner work environment
- Built-in counterbalance system engineered to reduce vibration
- Large rubberized clamping lever for quick paper installation

B03710 Includes: 1/3 Sheet Abrasive Paper, Hook & Loop, 120 Grit (794568-3-1), Dust Bag (140115-2), Punch Plate (451271-6)

Pad Size	3-5/8" x 7-1/4"
Abrasive Paper Size	3-5/8" x 9"
Orbits Per Minute	11,000 OPM
AMPS	1.7
Vibration (m/s ²)	3.5
Overall Length	10"
Net Weight	3.5 lbs.
Shipping Weight	4.9 lbs.



B04900V

1/2 Sheet Finishing Sander

- Uses commonly available 4-1/2" x 9" hook-and-loop or 4-1/2" x 11" half sheet abrasive paper
- Efficient through-the-pad dust collection system for a cleaner work environment
- Minimized vibration and contoured grips for added comfort
- Large trigger switch for easier operation
- Ideal for cabinet workers, boat builders and more

B04900V Includes: Dust Bag and Holder Assembly (193525-2), Paper Dust Bag, 5/pk (193526-0), Abrasive Paper 3120 (A-14093)

Pad Size	4-1/2" x 9"
Abrasive Paper Size	4-1/2" x 11"
Orbits Per Minute (variable speed)	4,000 - 10,000 OPM
AMPS	2.9
Vibration (m/s ²)	5
Overall Length	11-3/8"
Net Weight	6 lbs.
Shipping Weight	8.8 lbs.



9032

3/8" x 21" Belt Sander

- Variable speed control dial (980 - 5,600 ft./min.) to match the speed to the application
- Adjustable sanding arm pivots 100° for hard-to-reach areas
- Easily adjustable belt tracking with a turn of the knob
- Compact design with low weight (3.5 lbs.) and great balance for sanding in close quarters
- 3 different size arm assemblies and belts are available (1/4", 3/8", 1/2") for increased versatility

9032 Includes: (2) 3/8" x 21" Abrasive Belt, 80 Grit (A-34469-1), 3/8" Arm Assembly (125158-5)

Belt Size	3/8" x 21"
Belt Speed (variable speed)	980 - 5,600 ft./min.
AMPS	4.4
Overall Length	16-1/2"
Net Weight	3.5 lbs.
Shipping Weight	4.4 lbs.



9031

1-1/8" x 21" Belt Sander

- Versatile for use on wood, metal and fiberglass materials
- Ideal for woodworkers, artists, glaziers, welders, prefinished cabinet installers and finish carpenters
- Compact with less weight (4.6 lbs.) for use in close quarters
- Ball bearing construction for longer tool life
- Narrow belt and exposed front pulley for use on irregular shapes
- Multi-position side handle for easy and comfortable operation

9031 Includes: (2) 1-1/8" x 21" Abrasive Belt, 40 Grit (742301-7-1), (2) 1-1/8" x 21" Abrasive Belt, 60 Grit (742302-5-1), (2) 1-1/8" x 21" Abrasive Belt, 80 Grit (742303-3-1), (2) 1-1/8" x 21" Abrasive Belt, 100 Grit (742304-1-1), (2) 1-1/8" x 21" Abrasive Belt, 120 Grit (742305-9-1)

Belt Size	1-1/8" x 21"
Belt Speed (variable speed)	656 - 3,280 ft./min.
AMPS	5
Overall Length	15"
Net Weight	4.6 lbs.
Shipping Weight	6.32 lbs.



9903

3" x 21" Belt Sander

- Variable speed control dial (690 - 1,440 ft./min.) to match the speed to the application
- Auto-tracking belt system tracks belt without adjustment
- Innovative design for sanding flush to wall with nose and side of sander
- Front grip design for comfortable operation
- 3" wide belt with a speed of 1,440 ft./min. for fast material removal
- Dust bag for a cleaner work environment

9903 Includes: 3" x 21" Abrasive Belt, 80 Grit (742308-3-1), Dust Bag (122591-2)

Belt Size	3" x 21"
Belt Speed (variable speed)	690 - 1,440 ft./min.
AMPS	8.8
Overall Length	11-5/8"
Net Weight	9.5 lbs.
Shipping Weight	11.8 lbs.



9920

3" x 24" Belt Sander

- Variable speed control dial (690-1,440 ft./min.) to match the speed to the application
- Electronic speed control maintains constant speed under load
- Auto-tracking belt system tracks belt without adjustment
- Innovative design for sanding flush to wall with nose and side of sander
- Front grip design for comfortable operation
- Dust bag for a cleaner work environment

9920 Includes: 3" x 24" Abrasive Belt, 80 Grit (742312-8C-1), Dust Bag (122591-2)

Belt Size	3" x 24"
Belt Speed (variable speed)	690 - 1,440 ft./min.
AMPS	8.8
Overall Length	13-1/8"
Net Weight	9.9 lbs.
Shipping Weight	12.4 lbs.



9924DB

3" x 24" Belt Sander

- Powerful 7.8 AMP motor for fast material removal
- Extended base to allow flush sanding
- Innovative design for sanding flush to wall with nose and side of sander
- Extra long cord for easier maneuverability
- Easy-release belt lever for quick belt changes
- Ball bearing construction for longer tool life

9924DB Includes: 3" x 24" Abrasive Belt, 80 Grit (742312-8C-1), Dust Bag (122296-4)

Belt Size	3" x 24"
Belt Speed	1,300 ft./min.
AMPS	7.8
Overall Length	14"
Net Weight	10.6 lbs.
Shipping Weight	13.2 lbs.

SANDER ACCESSORIES

Hook & Loop Backing Pad

- Use with Hook & Loop abrasive paper

Type	Model	Part #
5" Round Flat Sanding	B05030/K, B05031K, B05041/K	D-17223
5" Round Contour Sanding		D-17245
4-1/2" x 9"	B04900V	193522-8

Pressure Sensitive Pad

- Use with Pressure Sensitive Abrasive Paper

Type	Model	Part #
5" round		743031-3
6" round	B04530	743032-1
4" x 4-3/8"		743030-5
5" round	B05030/K, B05031K, B05041/K	743056-7

4-3/8" x 4" Backing Pad

Type	Model	Part #
Finishing	B04556K	158324-9

6" Hook & Loop Rubber Backing Pad

Type	Model	Part #
General Purpose	B06030, B06040	A-91207
Flat Sanding		A-91198



9404

4" x 24" Belt Sander

- Powerful 8.8 AMP motor for fast material removal
- Low noise (84dB) for operator comfort
- Auto-tracking belt system tracks belt without adjustment
- Innovative design for sanding flush to wall with nose and side of sander
- Long 16.4 ft. power cord for easier maneuverability
- Dust bag for a cleaner work environment

9404 Includes: 4" x 24" Abrasive Belt, 80 Grit (742322-9-1), Dust Bag (122591-2)

Belt Size	4" x 24"
Belt Speed (variable speed)	690 - 1,440 ft./min.
AMPS	8.8
Overall Length	13-1/8"
Net Weight	10.3 lbs.
Shipping Weight	12.7 lbs.



9403

4" x 24" Belt Sander

- Low noise (84dB) for operator comfort
- 4" wide belt with a speed of 1,640 ft./min. for fast material removal
- Labyrinth construction seals and protects motor and bearings from contamination
- Large front grip is positioned for operator comfort
- Innovative design for sanding flush to wall with nose and side of sander

9403 Includes: 4" x 24" Abrasive Belt, 80 Grit (742322-9-1), Dust Bag (122562-9)

Belt Size	4" x 24"
Belt Speed	1,640 ft./min.
AMPS	11
Overall Length	13-7/8"
Net Weight	12.6 lbs.
Shipping Weight	15.6 lbs.



9741

Wheel Sander

- Powerful 7.8 AMP motor delivers 3,500 RPM for faster work
- Ideal for grain texture revealing, rust and paint removal, clearing dust, dirt, and grit from exterior surfaces, polishing, and concrete mold cleaning
- Innovative design for sanding flush to wall with nose and side of sander
- Adjustable front roller for uniform pressure to workpiece
- Well balanced with a low center of gravity for easier operation
- Electric brake for maximum productivity

9741 Includes: Nylon Brush Wheel, 100 Grit, Medium (794379-6), (2) Wrench (783204-6)

Wheel Size (width x diameter)	4-3/4" x 4"
No Load Speed	3,500 RPM
AMPS	7.8
Overall Length	12-1/4"
Net Weight	9.3 lbs.
Shipping Weight	18 lbs.



1002BA

4-3/8" Curved Base Planer

- Powerful 9.6 AMP motor with 15,000 RPM for improved performance
- Precision machined base for notching out logs at a 12-5/8" curved radius
- Large ejection chute for high rate of chip discharge
- Conveniently located front and rear grips for operator control
- Lock-on button for continuous operation

1002BA Includes: 4-3/8" Planer Blade, 2/pk (793008-8), Sharpening Holder (123055-9), Blade Gauge (123010-1), Socket Wrench (782209-3)

Planing Width	4-3/8"
Planing Depth	3/16"
No Load Speed	15,000 RPM
AMPS	9.6
Overall Length	13-11/32"
Net Weight	11.4 lbs.
Shipping Weight	15.4 lbs.



KP0800K

3-1/4" Planer, with Case

- 6.5 AMP motor delivers more output power for increased stock removal and superior finishes
- Planes up to 3-1/4" wide and 3/32" deep in a single pass
- Two-blade cutter head with 17,000 RPM delivers smooth finish and faster stock removal
- Spring-loaded stand elevates the base to protect the workpiece
- Easy blade setting system for fast blade installation

KP0800K Includes: 3-1/4" Planer Blade, 2/pk (D-46246), Blade Gauge (123010-1), Socket Wrench (782209-3), Guide Rule (165581-2), Tool Case (824892-1)

Planing Width	3-1/4"
Planing Depth	3/32"
No Load Speed	17,000 RPM
AMPS	6.5
Overall Length	11-1/4"
Net Weight	5.7 lbs.
Shipping Weight	12 lbs.



KP0810

3-1/4" Planer

- Planes up to 3-1/4" wide and 5/32" deep in a single pass
- Two-blade cutter head with 16,000 RPM delivers smooth finish and fast stock removal
- Chip ejection can be directed to either side of the tool for convenience
- Depth knob features an easy-to-read scale with stops in 0.1 mm increments for precise depth adjustment
- Rubberized grip and depth adjustment knob for comfort

KP0810 Includes: 3-1/4" Planer Blade, 2/pk (D-46246), Blade Gauge (123010-1), Socket Wrench (782209-3), Guide Rule (122785-9)

Planing Width	3-1/4"
Planing Depth	5/32"
No Load Speed	16,000 RPM
AMPS	7.5
Overall Length	11-3/8"
Net Weight	7.3 lbs.
Shipping Weight	10.2 lbs.



XPK01Z

18V LXT® 3-1/4" Planer

- 2-blade cutter head with double edge carbide blades for added performance and smooth finish
- High power-to-weight ratio; weighs only 7.4 lbs. with battery (battery not included)
- 14,000 RPM motor engineered for faster stock removal
- Click depth adjustment knob with easy-to-read scale with settings from 0" to 5/64"
- Spring-loaded stand elevates the base to protect the blades and workpiece
- Precision machined aluminum base for planing accuracy

XPK01Z Includes: Tool only, battery & charger not included
Socket Wrench (782209-3), Blade Set (D-16966), Blade Gauge (123010-1)

Planing Width	3-1/4"
Planing Depth	5/64"
No Load Speed	14,000 RPM
Battery	18V LXT® Lithium-Ion
Overall Length	13-1/8"
Net Weight (with battery)	17.4 lbs.
Shipping Weight	7.5 lbs.



1912B

4-3/8" Planer

- Powerful 7.5 AMP motor for improved performance
- Two-blade cutter head with 16,000 RPM delivers smooth finish and fast stock removal
- Lock-on button for continuous operation
- V-groove on front shoe for easy chamfer cutting
- Precision machined aluminum base for planing accuracy

1912B Includes: 4-3/8" Planer Blade, 2/pk (793008-8), Sharpening Holder (123055-9), Blade Gauge (123062-2), Socket Wrench (782209-3), Guide Rule (164371-0)

Planing Width	4-3/8"
Planing Depth	1/16"
No Load Speed	16,000 RPM
AMPS	7.5
Overall Length	14"
Net Weight	9.3 lbs.
Shipping Weight	10.9 lbs.



1806B

6-3/4" Planer

- Powerful 10.9 AMP motor with 15,000 RPM for improved performance
- Cuts 6-3/4" width in a single pass
- Comfortable handle and easy depth setting
- Large, sturdy sole plate for added stability
- Perfect alignment of front and back grips for better control

1806B Includes: 6-3/4" Planer Blade, 2/pk (793186-4), Hex Wrench (783202-0), Triangular Rule (762001-3), Bevel Guide (123053-3), Tool Case (821134-4), Sharpening Holder Assembly (123006-2)

Planing Width	6-3/4"
Planing Depth	1/16"
No Load Speed	15,000 RPM
AMPS	10.9
Overall Length	20-3/4"
Net Weight	19.8 lbs.
Shipping Weight	33 lbs.



KP312

12-1/4" Planer

- Powerful 15 AMP motor with 12,000 RPM for improved performance
- Large, conveniently located depth setting knob for easy adjustment
- Poly "V" belt designed with grooves efficiently transfers power from the motor to the blades
- Large ejection chute for high rate of chip discharge
- Front roller for easy moving over rough materials

KP312 Includes: 12-1/4" Planer Blade, 2/pk (B-02870), Socket Wrench (782209-3), Triangular Rule (762001-3)

Planing Width	12-1/4"
Planing Depth	1/8"
No Load Speed	12,000 RPM
AMPS	15
Overall Length	21-3/4"
Net Weight	40.6 lbs.
Shipping Weight	50.6 lbs.



PJ7000

Plate Joiner

- Powerful 5.6 AMP motor delivers 11,000 RPM for quick, precise cutting in a variety of woods
- Cast aluminum pivot fence with three positive stops at 0°, 45° and 90°
- Six depth settings with one-touch stops for most common biscuits sizes including #0, #10, and #20
- Large and easy-to-operate cam locks for angle guide and fence adjustments
- Large top grip handle for improved handling
- Slim and ergonomic body design for added comfort

PJ7000 Includes: 4" Carbide Tipped Blade for Plate Joiner (A-95118), Angle Guide (123148-2), Dust Bag (123150-5), Set Plate (415579-2), Lock Nut Wrench (782401-1), Tool Case (821509-7)

Blade Diameter	4"
Max. Cutting Depth	3/4"
No Load Speed	11,000 RPM
AMPS	5.6
Overall Length	11-7/8"
Net Weight	5.5 lbs.
Shipping Weight	8 lbs.



XJP03Z

18V LXT® Plate Joiner

- Rack-and-pinion vertical fence system engineered for accurate fence adjustments
- Cast aluminum pivot fence with three positive stops at 0°, 45° and 90°, and easy centering on 3/4" material
- Six depth settings with one-touch stops for #0, #10, and #20 and most common biscuits sizes
- Cordless plate joiner provides portability and performance in the field or in the shop without the cord
- Large and easy-to-operate cam locks for angle guide and fence adjustments
- "Tool-less" blade cover and shaft lock for fast and easy blade changes

XJP03Z Includes: Tool only, battery & charger not included 4" Carbide Tipped Blade for Plate Joiner (A-95118), Dust Bag (123150-5), Set Plate (415579-2), Lock Nut Wrench (782401-1)

Blade Diameter	4"
Max. Cutting Depth	3/4"
No Load Speed	12,000 RPM
Battery	18V LXT® Lithium-Ion
Overall Length	13-3/4"
Net Weight (with battery)	6.7 lbs.
Shipping Weight	8.2 lbs.

PLANER ACCESSORIES

Tungsten-Carbide Planer Blade

- Specially designed for fast and smooth planing
- Long lasting tungsten-carbide



Size	Model	2/Pkg. Part #
3-1/4"	N1900B, KP0810, KP0800K, XPK01	D-17223
4-3/8"	1912B	D-17245

High Speed Steel Planer Blade

- Made of fine grade steel
- Specially designed for fast and smooth planing



Size	Model	2/Pkg. Part #
3-1/4"	N1900B, KP0810, KP0800K, XPK01	D-46230
4-3/8"	1912B, 1002BA	793008-8
6-3/4"	1806B	793186-4
12"	KP312	B-02870

Double Edged Tungsten-Carbide Planer Blade



Type	Size	Model	2/Pkg. Part #
Blade Only ¹	3-1/4"	N1900B, KP0810, KP0800K, XPK01	D-46246
With set plates	3-1/4"		D-17239

¹ For use with set plate 343433-9

Blade Gauge Assembly

- For setting planer blades
- Easy to use



Model	Part #
N1900B, KP0800K	123010-1
1902, KP0810	123062-2

Bevel Guide

- Easily adjustable for beveling up to 45°
- Quick and easy bevel adjustment

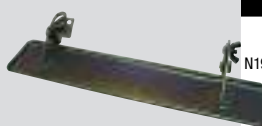

Model	Part #
N1900B, KP0800K, KP0810	123060-6

Dust Nozzle

- For non-clogging chip deflection in desired direction



- Adapters for connecting vacuum



Model	Part #
N1900B	132351-4 ² 181572-5
KP312	193733-5
KP0800K	451329-1

Sharpening Holder

- Holds dull 3-1/4" planer blades to allow honing with a sharpening stone
- Use with 3-1/4" planers blades

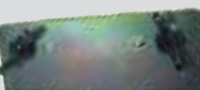

Model	Part #
N1900B, KP0810, KP0800K	123004-6

Straight Guide Rule

- For shiplapping applications
- Installs quickly and easily



Model	Part #
N1900B, 1912B, 1902	164371-0
KP0810	122785-9
KP0800K	165581-2

Sharpening Stone

- Produces consistently smooth and sharp cutting blades
- Creates durable and sharp blade edges for smooth planing of wood surfaces

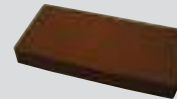

Model	Part #
All Planers	794061-7

Depth Guide



Model	Part #
KP0800K, N1900B	122793-0

Dust Bag



Model	Part #
KP0800K, KP0810	122793-0
N1900B	122230-4

Biscuits

- Feature finely-ground edges for improved fit
- Premium quality for a range of joinery applications



Type	100/Pkg. Part #	1,000/Pkg. Part #
#0	441001-A	—
	—	441001-B
#10	441002-A	—
	—	441002-B
#20	441003-A	—
	—	441003-B

Caution: For your safety, always use proper accessories on the proper tool. Accessory specifications and limitations (such as speed, size, mounting and guarding requirements, etc.) must match the specifications and limitations of the power tool. Use of accessories that are not recommended by Makita may cause injury. Carefully follow tool instruction manual and accessory instructions.

WOODWORKING ACCESSORIES

BLADE SHARPENER ACCESSORIES

Size	Model	Part #
7" Grinding Wheel	60 Coarse	A-24620
	1000 Medium	98202 A-24614
Maximum Safe Speed: 1,200 RPM	6000 Fine	A-24636
Guide Assembly Tool rest for knife & scissors		
	98202	192612-4

CHAIN MORTISER ACCESSORIES

Mortiser Chain

- Razor sharp edges for clean and accurate cutting
- Ideal for cutting notches or holes in thick wood stock



Size	Model	Part #
Cutter Chain 19/32"		A-16564
Cutter Chain 21/32"		A-16570
Cutter Chain 23/32"	7104L	A-16586
Cutter Chain 53/64"		A-16592
Cutter Chain 15/16"		A-16601



98202

Blade Sharpener

- Ideal for sharpening woodworking planer blades, bevel and lathe chisels, and jointer knives
- Quiet motor delivers 560 RPM for a fine finish
- Large 7-7/8" aluminum-oxide wheel for efficient sharpening
- Sharpens blades up to 15-3/4" long
- Water feed for cooling blades
- Less weight for easy transporting

98202 Includes: Grinding Wheel, 1,000 Grit (Medium), 98202 (A-24614), Wrench (341391-3), Rule Assembly (1222209-5)

Wheel Size	7-7/8"
No Load Speed	560 RPM
AMPS	1.1
Overall Length	15-3/8"
Net Weight	24.3 lbs.
Shipping Weight	26.9 lbs.



7104L

Chain Mortiser

- Razor sharp chain for clean, accurate cutting
- Extremely portable at only 38.1 lbs.
- 10.5 AMP motor (3,200 RPM) to quickly notch or cut holes in thick wood stock
- Cuts lap joints up to 5-1/8"
- Large adjustable vise and knob for versatility

7104L Includes: 21/32" Mortiser Chain (A-16570), Wrench (781204-0), Bar and Chain Oil, 100 cc (182229-1)

Max. Hole Width (longitudinal)	5-1/8"
Max. Hole Width (transverse)	1-1/4"
Max. Hole Depth	6-1/8"
No Load Speed	3,200 RPM
Chain Speed	1,000 FPM
AMPS	10.5
Overall Length	20-1/8"
Net Weight	38.1 lbs.
Shipping Weight	44 lbs.



UB1103

Blower

- Variable speed control dial and trigger (0-16,000 RPM) for increased performance
- Maximum air volume of 145 cfm for faster clean up in larger areas
- Two tools in one; quickly converts to a vacuum for added versatility
- Large trigger with conveniently located lock-on button
- Ergonomic handle designed for increased operator comfort
- Optional long nozzle available (part no. 134182-7) for harder to reach areas

UB1103 Includes: Rubber Blower Nozzle (132025-7), Dust Bag (123241-2)

AMPS	6.8
Max. Air Volume	145 CFM
Max. Air Velocity	203 MPH
No Load Speed (variable speed)	0 - 16,000 RPM
Overall Length	18-7/8"
Net Weight	4.3 lbs.
Shipping Weight	6.6 lbs.



NEW HG6031VK

Variable Temperature Heat Gun

- Variable temperature control dial (122 - 1,022°F) with 9 settings for precise control over a wide variety of applications
- Slide switch sets two air flow settings (7 and 14 CFM) for greater versatility
- Compact 1.5 lb. design features a rubberized pistol grip handle and an integrated rear stand
- Overheat protection prolongs tools life
- Compatible with various nozzle accessories for increased versatility (accessories sold separately)

HG6031VK Includes: Tool Case

Air Temperature (var. speed)	122° - 1,022° F
Air Volume (2 speed)	7 and 14 CFM
Temperature Control Dial	Yes
AMPS	13
Watts (AC only)	1,800
Overall Length	10-1/8"
Net Weight	1.5 lbs.
Shipping Weight	5.43 lbs.



NEW HG6530VK

Variable Temperature Heat Gun Kit with LCD Digital Display

- Push-button temperature control (122 - 1,202°F) for precise control over a wide variety of applications with LCD temperature reading
- Slide switch sets three air flow modes (cooling, low, high) for greater versatility
- Compact 2.0 lb. design features a rubberized pistol grip handle and an integrated rear stand
- Built-in tether notch (tether sold separately)

HG6530VK Includes: 1-3/8" Glass Protection Nozzle (PR00000028), 1-3/8" Wide-Slot Nozzle (PR00000029), 1-3/8" Reflector Nozzle (PR00000030), 1-3/8" Reduction Nozzle (PR00000031), Tool Case

Air Temperature (var. speed)	122° - 1,202° F
Air Volume (2 speed)	10 and 17.6 CFM
Temperature Control Dial	No
AMPS	13
Watts (AC only)	2,000
Net Weight	2 lbs.

HEAT GUN ACCESSORIES

Description	Model	Part #
1-3/8" Glass Protection Nozzle		PR00000028
1-3/8" Wide-Slot Nozzle		PR00000029
1-3/8" Reflector Nozzle		PR00000030
1-3/8" Reduction Nozzle	HG6031, HG6530VK	PR00000031
1-3/8" Overlap Welding Nozzle		PR00000032
1-3/8" Solder Sleeve Reflector Nozzle		PR00000033
1-3/8" Welding Nozzle (Use with PR00000039)		PR00000034
Speed Welding Nozzle		PR00000039
Pressure Roller	HG6031, HG6530VK	PR00000035
Welding Rod, ABS, 10/pk		PR00000036
Welding Rod, HDPE, 10/pk	HG6031, HG6530VK	PR00000037
Welding Rod, PP, 10/pk		PR00000038
Flex Scraper		PR00000040
Scraper Set	HG6031, HG6530VK	PR00000041





PERFORMANCE YOU NEED

PERFORMANCE

Powerful Honda GX160 4-stroke engine for increased performance and superior reliability

POWER

10-gallon twin tanks provide air supply to multiple nailers



BIG BORE™

MAC5501G

5.5 HP' Big Bore™ Gas Air Compressor

- Powerful Honda GX160 4-stroke engine for increased performance and superior reliability
- 10-gallon twin tanks provide air supply to multiple nailers
- "V" Twin Style Pump runs cooler and provides 12.5 CFM at 100 PSI
- Cast iron "V" Twin Style Pump with Big Bore™ cylinder and piston is engineered to run cooler with a faster recovery time for increased performance
- 12" non-flat tire for easier job site maneuverability
- Additional 1/2" ball valve for use as a non-regulated outlet; allows up to a 1/2" air hose to be attached for use with a secondary air tank
- Industrial-grade recoil starter with ergonomic grip and recoil rope design for faster, easier starts
- Automatic idle control engineered to reduce gas consumption and service life

MAC5501G Includes: (2) 1/4" Universal Quick Coupler, Male (447013-E)

Maximum Horsepower	5-1/2 HP
Running Horsepower	5.5 HP
Tank	10 gal.
Performance (40 PSI)	14 CFM
Performance (90 PSI)	12.5 CFM
Maximum Pressure	135 PSI
Overall Length	46"
Net Weight	192 lbs.
Shipping Weight	233 lbs.



BIG BORE™

MAC5200

3.0 HP' Big Bore™ Air Compressor

- Cast iron pump with Big Bore™ cylinder and piston is engineered to provide faster recovery time for improved performance
- Powerful 3.0 HP motor produces 6.5 CFM at 90 PSI for increased productivity
- Pump is oil lubricated for cooler running temperatures and reduced wear
- Durable cast iron cylinder reduces wear and increases pump life
- Folding handle with low-profile design for easy storage

MAC5200 Includes: (2) 1/4" Universal Quick Coupler, Male (447013-E), Air Compressor Oil (181122-A)

Maximum Horsepower	3 HP
Running Horsepower	2.1 HP
Tank	5.2 gal.
Performance (40 PSI)	6.9 CFM
Performance (90 PSI)	6.5 CFM
Maximum Pressure	140 PSI
Net Weight	88 lbs.
Shipping Weight	107 lbs.



BIG BORE™

MAC2400

2.5 HP' Big Bore™ Air Compressor

- Cast iron pump with Big Bore™ cylinder and piston is engineered to provide faster recovery time for improved performance
- Powerful 2.5 HP 4-Pole motor produces 4.2 CFM at 90 PSI for increased productivity and lower noise
- Roll-cage construction provides complete protection to withstand extreme jobsite environments
- Low AMP draw reduces incidences of tripped breakers at start up
- Copper finned discharge tubing for increased heat dissipation and reduced water in the tank

MAC2400 Includes: (2) 1/4" Universal Quick Coupler, Male (447013-E), Air Compressor Oil (181122-A)

Maximum Horsepower	2-1/2 HP
Running Horsepower	2.1 HP
Tank (twin stacked)	4.2 gal.
Performance (40 PSI)	4.8 CFM
Performance (90 PSI)	4.2 CFM
Maximum Pressure	130 PSI
Net Weight	77 lbs.
Shipping Weight	86.3 lbs.



BIG BORE™

MAC700

2.0 HP' Big Bore™ Air Compressor

- Cast iron pump with Big Bore™ cylinder and piston is engineered to provide faster recovery time for improved performance
- Powerful 2.0 HP 4-Pole motor produces 3.3 CFM at 90 PSI for increased productivity and lower noise
- Pump runs at lower RPM (1,730) resulting in lower noise (80dB) and improved pump durability
- Low AMP draw reduces incidences of tripped breakers at start up
- Roll-bar handle for portability and additional protection

MAC700 Includes: 1/4" Universal Quick Coupler, Male (447013-E), Air Compressor Oil (181122-A)

Maximum Horsepower	2 HP
Running Horsepower	1.7 HP
Tank	2.6 gal.
Performance (40 PSI)	3.8 CFM
Performance (90 PSI)	3.3 CFM
Maximum Pressure	130 PSI
Net Weight	52 lbs.
Shipping Weight	60.5 lbs.



AC001

Compact Air Compressor

- Powerful 1/6 maximum horsepower induction motor provides up to 125 PSI
- Lightweight design (23.1 lbs.) for increased job site portability
- Low noise for operator comfort; ideal for indoor use
- Low AMP draw reduces incidents of tripped breakers at start-up
- Roll cage construction for extra protection of pump and motor assembly

AC001 Includes: 1/4" Universal Quick Coupler, Male (447013-E)

Motor	1/6 HP
Running Horsepower	1/6 HP
Tank	1 gal.
Performance (40 PSI)	.58 CFM
Performance (90 PSI)	.45 CFM
Maximum Pressure	125 PSI
Net Weight	23.1 lbs.
Shipping Weight	26.9 lbs.



PNEUMATICS

AC310H

2.5 HP' High Pressure Air Compressor

- Dual capacity: two universal couplers for conventional nailers and two couplers for high pressure nailers
- Low amp draw reduces incidences of tripped breakers and voltage drop during start-ups
- Efficient dual-head (2-stage) pump provides faster recovery time and improved performance
- Pump runs at lower RPM (1,720) resulting in lower noise and improved pump durability
- Four-pole induction motor for increased efficiency and added durability

AC310H Includes: (2) 1/4" High Pressure Universal Quick Coupler, Female (HY00000337), (2) High Pressure Quick Coupler (HY00000331)

Maximum Horsepower	2-1/2 HP
Running Horsepower	1.9 HP
Tank	1.6 gal.
Performance (40 PSI)	3.7 CFM
Performance (90 PSI)	3.6 CFM
Performance (300 PSI)	2.7 CFM
Maximum Pressure	400 PSI
Net Weight	79.4 lbs.
Shipping Weight	88.16 lbs.



PNEUMATICS

AN635H

2-1/2" High Pressure Siding Coil Nailer

- Innovative High Pressure technology enables the nailer to operate at 170-320 PSI for more consistent flush nailing
- "Tool-less" depth adjustment engineered for more precise flush and countersink nailing
- Includes both a single sequential actuation trigger or a contact actuation trigger allowing operator to control nailing operations
- Side exhaust port directs exhaust air away from operator
- High capacity canister holds up to 400 nails for high production applications
- 3.5 SCFM @ 250PSI

AN635H Includes: No-Mar Tip (421574-2), Air Tool Oil (194381-3), Tool Case (824490-1), Safety Goggles (192517-8), Bump Fire Trigger Assembly (123888-2), Sequential Trigger Assembly (135832-7)

Power Type	Pneumatic
Operating Air Pressure	170 - 320 PSI
Minimum Recommended Air Delivery	3.5 SCFM @ 250 PSI
Nail Size	1-1/4" - 2-1/2", .99" - .113" shank diameter plastic & wire collated
Maximum Magazine Capacity	400
Fastening category	Siding
Dimensions (LxWxH)	11-3/4" x 4-7/8" x 11-5/8"
Net Weight	4.9 lbs.
Shipping Weight	10.3 lbs.

*Maximum horsepower

DURABLE & ROBUST PERFORMANCE

CONTROL

2-mode selector switch allows operator to select contact or sequential nailing options

DURABILITY

Solid top-loading aluminum magazine for longer life



21"

NEW AN924

21" Full Round Head 3-1/2" Framing Nailer

- Faster nail driving speed for maximum performance
- Lightweight design at only 8.3 lbs.
- Large capacity air chamber for increased power to drive nails up to 3-1/2" x .148 in diameter
- Solid top-loading aluminum magazine for longer life
- Front magazine cover for additional nail support
- Heat treated S7 steel driver blade for durability
- "Tool-less" depth adjustment engineered for more precise flush and countersink nailing
- Nail lock-out mechanism protects tool and work surface from dry-fires
- Reversible hook allows tool to remain close by

AN924 Includes: Safety Glasses, Air Fitting, Pneumatic Nailer Oil, Hex Wrench

Power Type	Pneumatic
Operating Air Pressure	70 - 120 PSI
Minimum Recommended Air Delivery	6.2 SCFM @ 90 PSI
Nail Size	2" - 3-1/2" .113" - .148" shank diameter plastic collated
Maximum Magazine Capacity	73
Fastening category	Framing
Dimensions (LxWxH)	22" x 4-5/8" x 13-3/4"
Net Weight	8.3 lbs.
Shipping Weight	11.75 lbs.



15"

AN902

3-1/2" Framing Coil Nailer

- "Tool-less" depth adjustment engineered for more precise flush and countersink nailing
- Drives 1-3/4" to 3-1/2" coil framing nails
- Easy access nose design for clearing jammed nails
- Easy loading canister with nail size adjustment provides maximum versatility
- Rubberized handle for better fit and added comfort
- Contact mode trigger allows operator to control nailing operations

AN902 Includes: Pneumatic Nailer Oil (181434-7), Safety Goggles (191687-A), No-Mar Tip (BA00000372)

Power Type	Pneumatic
Operating Air Pressure	60 - 120 PSI
Minimum Recommended Air Delivery	5.6 SCFM @ 90 PSI
Nail Size	1-3/4" - 3-1/2" .099" - .148" shank diameter wire collated
Maximum Magazine Capacity	300
Fastening category	Framing
Dimensions (LxWxH)	12-1/2" x 5" x 14-7/8"
Net Weight	7.7 lbs.
Shipping Weight	10.1 lbs.



15"

AN611

2-1/2" Siding Coil Nailer

- "Tool-less" depth adjustment engineered for more precise flush and countersink nailing
- 3-mode selector switch (contact, sequential, lock) allows user control over nailing options
- Built-in air filter minimizes dust and debris from entering tool
- Multi-directional exhaust port directs exhaust air away from user
- Easy-loading canister with nail size adjustment provides maximum versatility
- 3.6 SCFM @ 90PSI

AN611 Includes: Pneumatic Nailer Oil (181434-7), Hex Wrench (783202-0), Tool Case (824490-1), Safety Goggles (191687-A), Air Fitting (311006-A)

Power Type	Pneumatic
Operating Air Pressure	65 - 120 PSI
Minimum Recommended Air Delivery	3.6 SCFM @ 90 PSI
Nail Size	1-1/4" - 2-1/2" .080" - .099" shank diameter
Maximum Magazine Capacity	400
Fastening category	Siding
Dimensions (LxWxH)	13-1/16" x 5" x 12-1/2"
Net Weight	5.1 lbs.
Shipping Weight	10.15 lbs.



15"

NEW AN454

1-3/4" Coil Roofing Nailer

- Faster nail driving speed for maximum performance
- Aluminum housing for longer tool life
- Easy, one-step open, adjustable canister system for faster, more precise nail loading
- Smooth nose design for easy removal of tar buildup
- Removable nosepiece assembly for easy cleaning or maintenance
- Large carbide inserts on nose piece for long lasting performance

AN454 Includes: Hex Wrench (783202-0), Pneumatic Nailer Oil (181434-7), Safety Goggles (192517-8), Air Fitting (311006-A)

Power Type	Pneumatic
Operating Air Pressure	70 - 120 PSI
Minimum Recommended Air Delivery	3.7 SCFM @ 90 PSI
Nail Size	3/4" - 1-3/4"
Maximum Magazine Capacity	120
Fastening category	Roofing
Dimensions (LxWxH)	10-1/8" x 4-5/8" x 10-5/8"
Net Weight	5.2 lbs.
Shipping Weight	7.28 lbs.



15 GAUGE

AF635

2-1/2" Angled Finish Nailer, 15 Gauge

- "Tool-less" depth adjustment for more precise nailing
- Magnesium body, aluminum magazine and cylinder deliver strength and durability
- Nail lock-out mechanism protects tool and work surface from dry-fires
- Efficient motor design offers leading power performance
- Built-in air duster provides convenient air flow to clear work surface
- "Tool-less" easy to clear nose for fast and easy nail extraction

AF635 Includes: Pneumatic Nailer Oil (181434-7), Safety Glasses, (2) No-Mar Tip, Air Fitting, Tool Case

Power Type	Pneumatic
Operating Air Pressure	70 - 120 PSI
Minimum Recommended Air Delivery	3.4 SCFM @ 90 PSI
Nail Size	1-1/4" to 2-1/2" (15 ga. DA style)
Maximum Magazine Capacity	100
Fastening category	Finish
Dimensions (LxWxH)	13-3/8" x 3-15/16" x 12-1/8"
Net Weight	4 lbs.
Shipping Weight	9.7 lbs.



15 GAUGE

AF601

2-1/2" Straight Finish Nailer, 16 Gauge

- "Tool-less" depth adjustment for more precise nailing
- Efficient motor design offers leading power performance
- Nail lock-out mechanism protects tool and work surface from dry-fires
- Built-in air duster provides convenient air flow to clear work surface
- 2-mode selector switch for control over nailing operation
- Multi-directional exhaust port directs exhaust air away from operator

AF601 Includes: Pneumatic Nailer Oil (181434-7), Safety Glasses, (2) No-Mar Tip, Air Fitting, Tool Case

Power Type	Pneumatic
Operating Air Pressure	70 - 120 PSI
Minimum Recommended Air Delivery	2.7 SCFM @ 90 PSI
Nail Size	1" to 2-1/2" (16 ga.)
Maximum Magazine Capacity	100
Fastening category	Finish
Dimensions (LxWxH)	12" x 3-3/4" x 11-3/4"
Net Weight	3.8 lbs.
Shipping Weight	9 lbs.



NEW XNB02RJ

XNB02Z

18V LXT® 2-1/2" Straight Finish Nailer Kit, 16 Ga.

- Powerful motor design drives standard 16 gauge, straight finish nails from 1" to 2-1/2" in length
- Compact center height enables viewing around the nose tip when fastening in tight spots
- Narrow nose design allows easy nailing access in confined areas
- Nail length markings and large windows on the magazine for easy checking of nails
- Anti-dry fire mechanism engineered to help prevent driving blanks and damage to work surface

XNB02RJ Includes: 18V LXT® 2-1/2" Straight Finish Nailer, 16 Gauge (XNB02Z), 18V LXT® Lithium-Ion Rapid Optimum Charger (DC18RC), (2) 18V LXT® Lithium-Ion Compact 2.0Ah Battery (BL1820B), Interlocking Case, X-Large (197213-3), (2) No-Mar Tip (424443-6), Safety Glasses, Belt Clip

XNB02Z Includes: Tool only, battery & charger not included (2) No-Mar Tip (424443-6), Safety Glasses, Belt Clip

Battery	18V LXT® Lithium-Ion
Fastening category	Finish
Nail Size	1" to 2-1/2" (16 ga.)
Maximum Magazine Capacity	110
Dimensions (LxWxH)	11-5/8" x 4-1/4" x 12-1/2"
Net Weight (with battery)	7.5 lbs.
Shipping Weight	20.57 lbs.





18 GAUGE

PNEUMATICS

NEW AF506

2" Brad Nailer, 18 Gauge

- Powerful motor drives a range of 18 gauge brad nails from 5/8" to 2" into hard or soft wood applications
- Aluminum body, magazine and cylinder for strength and durability; weighs only 2.9 lbs.
- Easy to use "tool-less" depth adjustment dial for a wide variety of finish applications
- Built-in air duster provides convenient air flow to clear work surface
- "Tool-less" easy to clear nose for fast and easy nail extraction

AF506 Includes: Pneumatic Nailer Oil, (2) No-mar tip, Air Fitting, Tool Case, Safety Glasses

Power Type	Pneumatic
Operating Air Pressure	70 - 120 PSI
Minimum Recommended Air Delivery	1.5 SCFM @ 90 PSI
Nail Size	5/8" to 2" (18 ga.)
Maximum Magazine Capacity	100
Fastening category	Brad
Dimensions (LxWxH)	9-7/8" x 2-3/4" x 10-1/8"
Net Weight	2.9 lbs.
Shipping Weight	7.5 lbs.



LXT

XNB01Z

18V LXT® 2" Brad Nailer, 18 Gauge

- Drives up to 1,660 finish nails using a 5.0Ah 18V LXT® Battery (battery not included)*
- Drives a range of 18 gauge brad nails from 5/8" to 2"; magazine capacity up to 100 nails
- 2-mode selector switch for control of nailing operation
- "Tool-less" depth adjustment for precise flush and countersink finish
- Anti-dry drive mechanism engineered to prevent driving blanks and damage to work surface
- Battery gauge indicates battery charge level

XNB01Z Includes: Tool only, battery & charger not included

Battery	18V LXT® Lithium-Ion
Nail Size	5/8" to 2" (18 ga.)
Maximum Magazine Capacity	100
Fastening category	Brad
Dimensions (LxWxH)	11-5/8" x 3-13/16" x 12-1/2"
Net Weight (with battery)	7.7 lbs.
Shipping Weight	8 lbs.

*Attaching plywood to Douglas fir with 5/8" to 2" nail



23 GAUGE

PNEUMATICS

AF353

1-3/8" Pin Nailer, 23 Gauge

- Powerful motor drives standard headless pins sized 5/8", 11/16", 3/4", 1", 1-3/16" and 1-3/8"
- Aluminum body, magazine and cylinder for strength and durability
- Nail lock-out mechanism protects tool and work surface from dry-fires
- Side, drop-in loading magazine holds up to 130 nails for maximum efficiency
- Built-in air duster provides convenient air flow to clear work surface
- Double, 2-finger trigger helps prevent accidental firing

AF353 Includes: Pneumatic Nailer Oil (181434-7), Safety Glasses, (2) No-Mar Tip, Air Fitting, Hex Wrench, Tool Case

Power Type	Pneumatic
Operating Air Pressure	65 - 100 PSI
Minimum Recommended Air Delivery	.9 SCFM @ 90 PSI
Nail Size	5/8", 11/16", 3/4", 1", 1-3/16", 1-3/8" (23 ga.)
Maximum Magazine Capacity	130
Fastening category	Pin
Dimensions (LxWxH)	8-3/16" x 2-5/8" x 7-1/2"
Net Weight	2 lbs.
Shipping Weight	6.38 lbs.



LXT

XTP02Z

18V LXT® 1-3/8" Pin Nailer, 23 Gauge

- Drives 6 different lengths, 5/8", 11/16", 3/4", 1", 1-3/16" and 1-3/8", of 23 gauge pin nails (tool does not work with 1-1/4" pin nails)
- Magazine capacity up to 120 pin nails
- Refined firing mechanism reduces recoil; reduces force required on the work surface when driving pin nails
- "Tool-less" depth adjustment for precise flush and countersink finish
- Anti-dry fire mechanism engineered to prevent driving blanks and damage to work surface
- Compact and ergonomic design at only 10-1/8" long

XTP02Z Includes: Tool only, battery & charger not included
Safety Glasses (195246-2), (2) Nose No-Mar Tip, XTP02 (424955-9), Belt Clip (346449-3), Hex Wrench 3 (783201-2)

Battery	18V LXT® Lithium-Ion
Nail Size	5/8", 11/16", 3/4", 1", 1-3/16", 1-3/8" (23 ga.)
Maximum Magazine Capacity	120
Fastening category	Pin
Dimensions (LxWxH)	10-1/8" x 3-1/8" x 8-7/8"
Net Weight (with battery)	4 lbs.
Shipping Weight	4.7 lbs.



16 GAUGE

PNEUMATICS

AT2550A

1" Wide Crown Stapler

- Depth adjustment engineered for more precise flush and countersink finish
- Quick release cam-lock opens nose assembly to clear jammed staples
- Built-in air filter minimizes dust and debris from entering the tool
- Ideal for lathing, roofing and sheathing
- Top-loading magazine allows operator to quickly load 16 gauge, 1" wide crown staples from 1" to 2" in length
- Multi directional exhaust port directs exhaust air away from user

AT2550A Includes: Hex Wrench (A0913-0011), Hook (A0316-0311), Oil Supply (A09070001), Safety Goggles (A09080-171), Air Fitting (311006-A)

Power Type	Pneumatic
Operating Air Pressure	65 - 120 PSI
Minimum Recommended Air Delivery	2.3 SCFM @ 90 PSI
Crown	1"
Gauge	16
Leg Length	1" to 2"
Maximum Magazine Capacity	140
Fastening category	Stapler
Dimensions (LxWxH)	14-1/2" x 3" x 10-1/4"
Net Weight	5.1 lbs.
Shipping Weight	7.1 lbs.



16 GAUGE

PNEUMATICS

AT1150A

7/16" Medium Crown Stapler

- Depth adjustment engineered for more precise flush and countersink stapling
- Quick release cam-lock opens nose assembly to clear jammed staples
- Built-in air filter minimizes dust and debris from entering the tool
- Ideal for crating, decking, insulation, and sheathing applications
- Top loading magazine allows user to quickly load 16 GA 7/16" staples varying in length from 1" to 2"
- Multi directional exhaust port directs exhaust air away from user

AT1150A Includes: Hex Wrench (A0913-0011), Hook (A0316-0311), Oil Supply (A09070001), Safety Goggles (A09080-171), Air Fitting (311006-A)

Power Type	Pneumatic
Operating Air Pressure	65 - 120 PSI
Minimum Recommended Air Delivery	2.5 SCFM @ 90 PSI
Crown	7/16"
Gauge	16
Leg Length	1" to 2"
Maximum Magazine Capacity	140
Fastening category	Stapler
Dimensions (LxWxH)	14-1/2" x 3-7/16" x 11-3/8"
Net Weight	4.9 lbs.
Shipping Weight	6.75 lbs.



18 GAUGE

PNEUMATICS

AT638A

1/4" Narrow Crown Stapler, 18 Gauge

- "Tool-less" depth adjustment for more precise stapling
- Powerful motor drives standard 18 gauge, 1/4" narrow crown staples from 1/2" to 1-1/2" in length
- Built-in air duster provides convenient air flow to clear work surface
- 2-mode selector switch allows operator to select sequential or contact stapling operation
- Multi-directional exhaust port directs exhaust air away from operator
- Efficient motor design offers leading power performance

AT638A Includes: Pneumatic Nailer Oil (181434-7), Safety Glasses, (2) No-Mar Tip, Air Fitting, Tool Case

Power Type	Pneumatic
Operating Air Pressure	70 - 120 PSI
Minimum Recommended Air Delivery	1.6 SCFM @ 90 PSI
Crown	1/4"
Gauge	18
Leg Length	5/8" to 1-1/2"
Maximum Magazine Capacity	100
Fastening category	Stapler
Dimensions (LxWxH)	9" x 2-15/16" x 9-7/8"
Net Weight	2.7 lbs.
Shipping Weight	6.7 lbs.



5.0Ah BATTERY
2
2
1

LXT

XTS01T

XTS01Z

18V LXT® 3/8" Crown Stapler Kit

- Fastens a wide range of 3/8" crown staples from 3/8" to 7/8" in length; also utilizes Arrow® T50 type flat crown staples
- A convenient window on magazine shows the number of remaining staples
- Spring-loaded driving mechanism allows for a more compact tool with less weight
- Contact actuation is well-suited for production environment
- Rugged machined aluminum magazine ensures smooth loading and feeding of staples
- Easy to use depth control setting by turning adjustment knob

XTS01T Includes: 18V LXT® 3/8" Crown Stapler (XTS01Z), (2) 18V LXT® Lithium-Ion 5.0Ah Battery (BL1850B), 18V LXT® Lithium-Ion Rapid Optimum Charger (DC18RC), Tool Bag

Battery	18V LXT® Lithium-Ion
Crown	3/8"
Gauge	T50® Style
Leg Length	3/8" to 7/8"
Maximum Magazine Capacity	98
Fastening category	Stapler
Dimensions (LxWxH)	9-7/8" x 3-5/8" x 8-3/8"
Net Weight (with battery)	5.3 lbs.
Shipping Weight	13.6 lbs.



GET WHAT YOU NEED

USE THE SAME BATTERIES & CHARGERS WITH ALL 36V & 18V LXT® TOOLS

X2
18V + 18V = 36V



36V

WITH 2 BATTERIES

GAS PERFORMANCE

LXT®



18V

WITH 1 BATTERY

GAS-LIKE REPLACEMENT



ONE SYSTEM WITH OVER 200 SOLUTIONS

From on the ranch to in your home, the Makita LXT® system allows you to use the same battery for dozens of different tasks. With over 200 tools and growing, the LXT® platform is the world's largest 18V lithium-ion lineup and gives the user an unprecedented range of applications using the same batteries.



LXT BRUSHLESS

XCU04PT

XCU04Z



18V X2 (36V) LXT® Brushless 16" Chain Saw Kit

- Makita-built Outer Rotor BL™ Brushless Motor direct-drive system provides high power efficiency equivalent to a 32cc gas chain saw
- Two 18V LXT® Lithium-Ion batteries deliver 36V power and performance without leaving the 18V LXT® platform
- "Tool-less" chain adjustment for convenient operation and maintenance
- Variable speed trigger and high chain speed (0-3,940 FPM) for improved cutting performance
- Adjustable automatic chain lubrication with large oil reservoir

XCU04PT Includes: 18V X2 (36V) LXT® Brushless 16" Chain Saw (XCU04Z), (2) 18V LXT® Lithium-Ion 5.0Ah Battery (BL1850B), 18V LXT® Lithium-Ion Dual Port Charger (DC18RD), 16" Saw Chain, 3/8", .043" (196742-3), 16" Guide Bar, 3/8", .043" (165247-4), 16" Bar Cover

XCU04Z Includes: Tool only, battery & charger not included 16" Saw Chain, 3/8", .043" (196742-3), 16" Guide Bar, 3/8", .043" (165247-4), Guide Bar Cover (419288-5)

Guide Bar Length	16"
Pitch	3/8"
Gauge	.043"
Chain Speed	3,940 FPM
Net Weight (with battery)	11.8 lbs.
Battery	2X 18V LXT® Lithium-Ion
Overall Length	32-1/4"
Shipping Weight	19.2 lbs.

NO GAS, NO EMISSIONS

LXT X2 18V + 18V 36V BRUSHLESS



XCU07Z

XCU07PT

18V X2 (36V) LXT® Brushless 14" Chain Saw Kit

- Makita-built Outer Rotor BL™ Brushless Motor direct-drive system provides high power efficiency equivalent to a 32cc gas chain saw
- Two 18V LXT® Lithium-Ion batteries deliver 36V power and performance without leaving the 18V LXT® platform
- Captured bar nuts and lateral chain tensioning for convenient operation and maintenance
- Variable speed trigger and high chain speed (0-3,940 FPM) for improved cutting performance
- Adjustable automatic chain lubrication with large oil reservoir
- Weighs only 11.5 lbs. with batteries for reduced operator fatigue
- Features Extreme Protection Technology (XPT™) which is engineered to provide increased dust and water resistance in harsh job site conditions. Equipped with Star Protection Computer Controls™ to protect against overloading, over-discharging and over-heating

XCU07PT Includes: 18V X2 (36V) LXT® Brushless 14" Chain Saw (XCU07Z), (2) 18V LXT® Lithium-Ion 5.0Ah Battery (BL1850B), 18V LXT® Lithium-Ion Dual Port Charger (DC18RD), 14" Guide Bar, 3/8", .043" (165246-6), 14" Saw Chain, 3/8", .043" (196741-5), 14" Chain Cover (419242-9), Sprock

XCU07Z Includes: Tool only, battery & charger not included 14" Guide Bar, 3/8", .043" (165246-6), 14" Saw Chain, 3/8", .043" (196741-5), 14" Chain Cover (419242-9), Sprock

Guide Bar Length	14"
Pitch	3/8"
Gauge	.043"
Chain Speed	3,940 FPM
Net Weight (with battery)	11.5 lbs.
Battery	2X 18V LXT® Lithium-Ion
Shipping Weight	18.9 lbs.

POWER

Outer Rotor BL™ Brushless Motor provides high power efficiency equivalent to a 32cc gas chain saw



DESIGN

Captured bar nuts and lateral chain tensioning for convenient operation and maintenance



SPEED

Variable speed trigger and high chain speed (0-3,940 FPM) for improved cutting performance



LXT BRUSHLESS

XCU03PT

XCU03Z



18V X2 (36V) LXT® Brushless 14" Chain Saw Kit

- Makita-built Outer Rotor BL™ Brushless Motor direct-drive system provides high power efficiency equivalent to a 32cc gas chain saw
- Two 18V LXT® Lithium-Ion batteries deliver 36V power and performance without leaving the 18V LXT® platform
- "Tool-less" chain adjustment for convenient operation and maintenance

XCU03PT Includes: 18V X2 (36V) LXT® Brushless 14" Chain Saw (XCU03Z), (2) 18V LXT® Lithium-Ion 5.0Ah Battery (BL1850B), 18V LXT® Lithium-Ion Dual Port Charger (DC18RD), 14" Guide Bar, 3/8", .043" (165246-6), 14" Saw Chain, 3/8", .043" (196741-5), 14" Chain Cover (419242-9)

XCU03Z Includes: Tool only, battery & charger not included 14" Guide Bar, 3/8", .043" (165246-6), 14" Saw Chain, 3/8", .043" (196741-5), 14" Chain Cover (419242-9)

Guide Bar Length	14"
Pitch	3/8"
Gauge	.043"
Chain Speed	3,940 FPM
Net Weight (with battery)	11.5 lbs.
Battery	2X 18V LXT® Lithium-Ion
Overall Length	30-1/2"
Shipping Weight	18.9 lbs.



LXT X2 18V + 18V 36V BRUSHLESS

XCU02PT

XCU02Z



18V X2 (36V) LXT® 12" Chain Saw Kit

- Makita-built motor delivers 1,650 FPM chain speed for faster cutting
- Two 18V LXT® Lithium-Ion batteries deliver power and performance without leaving the 18V LXT® platform
- "Tool-less" chain adjustment for convenient operation and maintenance
- Low noise level at only 87 dB(A) and zero emissions for operator comfort
- 12" guide bar for increased capacity
- Weighs only 10.1 lbs. with batteries for reduced operator fatigue

XCU02PT Includes: 18V X2 (36V) LXT® 12" Chain Saw (XCU02Z), (2) 18V LXT® Lithium-Ion 5.0Ah Battery (BL1850B), 18V LXT® Lithium-Ion Dual Port Charger (DC18RD), 12" Guide Bar (165245-8), 12" Saw Chain 3/8", .043" (531-291-646), Spike Bar (197819-7)

XCU02Z Includes: Tool only, battery & charger not included 12" Guide Bar (165245-8), 12" Saw Chain 3/8", .043" (531-291-646), Spike Bar (197819-7), Blade Cover

Guide Bar Length	12"
Pitch	3/8"
Gauge	.043"
Chain Speed	1,650 FPM
Net Weight (with battery)	10.1 lbs.
Battery	2X 18V LXT® Lithium-Ion
Overall Length	24-5/8"
Shipping Weight	19.8 lbs.



LXT BRUSHLESS

XCU06T

XCU06Z



18V LXT® Brushless 18" Top Handle Chain Saw Kit

- Compact top handle design built for the professional tree care industry
- Makita-built Outer Rotor BL™ Brushless Motor direct-drive system provides high power efficiency
- Torque boost mode for cutting dense material
- Captured bar nut and lateral chain tensioning for convenient operation and maintenance
- Variable speed trigger and high chain speed (0-4,720 FPM) for improved cutting performance

XCU06T Includes: (2) 18V LXT® Lithium-Ion 5.0Ah Battery (BL1850B), 18V LXT® Lithium-Ion Rapid Optimum Charger (DC18RC), 10" Guide Bar, 3/8", .043" (161846-0), 10" Saw Chain, 3/8", .043" (199075-5), Bumper Spike (199068-2), Universal Wrench, 13mm x 16mm (782023-7)

XCU06Z Includes: Tool only, battery & charger not included 10" Guide Bar, 3/8", .043" (161846-0), 10" Saw Chain, 3/8", .043" (199075-5), Bumper Spike (199068-2), Universal Wrench, 13mm x 16mm (782023-7)

Guide Bar Length	10"
Pitch	3/8"
Gauge	.043"
Chain Speed	4,720 FPM
Net Weight (with battery)	7.2 lbs.
Battery	18V LXT® Lithium-Ion
Overall Length	19-3/8"
Shipping Weight	13.35 lbs.



LXT

XCU01Z

18V LXT® 4-1/2" Chain Saw

- 4-1/2" guide bar is ideal for limbing
- Makita-built motor delivers 980 FPM for increased cutting speed
- "Tool-less" chain adjustments for convenient operation and maintenance
- Compact and ergonomic design at only 16-5/8" long
- Electric brake for maximum productivity
- Compact and ergonomic design at only 16-5/8" long
- Weighs only 5.4 lbs. with battery (battery not included) for reduced operator fatigue
- Adjustable automatic chain lubrication with large oil reservoir

XCU01Z Includes: Tool only, battery & charger not included 4-1/2" Chain Saw Chain, 1/4", .050" (791284-8), 4-1/2" Guide Bar (158476-6), Bar and Chain Oil, 1 Gallon (181116-A), Bar and Chain Oil, Winter, 1 Gallon (1-03159), Combo Safety Helmet (986-200-002), Chain Saw Chaps (841008-A)

Guide Bar Length	4-1/2"
Pitch	1/4"
Gauge	.050"
Chain Speed	980 FPM
Net Weight (with battery)	5.4 lbs.
Battery	18V LXT® Lithium-Ion
Overall Length	16-5/8"
Shipping Weight	7.1 lbs.



LXT BRUSHLESS

XBU02PT

XBU02Z

18V X2 (36V) LXT® Brushless Blower Kit

- Delivers up to 28 minutes of run time at mid-speed (15,800 RPM) using two 18V LXT® 5.0Ah batteries
- BL™ Brushless motor delivers up to 120 MPH air velocity and 473 CFM of air volume
- Sound pressure rating of 61 dB(A); measured per ANSI B 175.2 standard
- Zero emissions and reduced maintenance; no need for gas or oil
- 6-stage air velocity/volume selection dial with variable speed control trigger
- Two 18V LXT® Lithium-Ion batteries deliver the power and run time for gas powered demands without leaving the 18V LXT® platform

XBU02PT Includes: 18V X2 (36V) LXT® Brushless Blower (XBU02Z), (2) 18V LXT® Lithium-Ion 5.0Ah Battery (BL1850B), 18V LXT® Lithium-Ion Dual Port Charger (DC18RD)

XBU02Z Includes: Tool only, battery & charger not included 3-Stage Telescoping Blower Nozzle (455915-0)

Max. Air Volume	473 CFM
Max. Air Velocity	120 MPH
No Load Speed (variable speed)	11,400 - 21,500 RPM
Battery	2X 18V LXT® Lithium-Ion
Sound Pressure (per ANSI B175.2 standard)	61 dB(A)
Overall Length	36-5/8"
Net Weight (with battery)	9 lbs.
Shipping Weight	17.6 lbs.



LXT X2 18V + 18V 36V

XBU01PT

XBU01Z

18V X2 (36V) LXT® Blower Kit

- Delivers up to 28 minutes of run time using two 5.0Ah 18V LXT® batteries on highest speed setting
- Makita-built motor produces a maximum air velocity of 208 MPH and 155 CFM of air volume
- 2-speed (Low: 10,000 RPM, High: 17,000 RPM) design to match the speed to application
- Two 18V LXT® Lithium-Ion batteries deliver the power and run time for corded demands without leaving the 18V LXT® platform
- Zero emissions and reduced maintenance for increased ease of use

XBU01PT Includes: 18V X2 (36V) LXT® Blower (XBU01Z), (2) 18V LXT® Lithium-Ion 5.0Ah Battery (BL1850B), 18V LXT® Lithium-Ion Dual Port Charger (DC18RD)

XBU01Z Includes: Tool only, battery & charger not included Long Blower Nozzle (452123-4)

Max. Air Volume	155 CFM
Max. Air Velocity	208 MPH
No Load Speed (2 spd)	10,000/17,000 RPM
Battery	2X 18V LXT® Lithium-Ion
Sound Pressure (per ANSI B175.2 standard)	60.6 dB(A)
Overall Length	36-1/4"
Net Weight (with battery)	8 lbs.
Shipping Weight	13.1 lbs.



LXT

DUB183Z

18V LXT® Floor Blower

- Up to 18 minutes of continuous operation at high speed using 18V LXT® 5.0Ah battery BL1850B (battery not included)
- Variable speed (0-18,000 RPM) for optimum air volume control enables user to match the speed to the application
- Makita-built variable 3-speed motor produces a maximum air velocity of 116 MPH and 91 CFM of air volume
- Long nozzle with a curved flat end enables comfortable operation of blower in an upright standing position
- Zero emissions and reduced maintenance; no need for gas or oil
- Compact and ergonomic design at only 33-1/4" long

DUB183Z Includes: Tool only, battery & charger not included Long Blower Nozzle (TP00000199)

Max. Air Volume	91 CFM
Max. Air Velocity	116 MPH
No Load Speed (variable speed)	0 - 18,000 RPM
Battery	18V LXT® Lithium-Ion
Overall Length	33-1/4"
Net Weight (with battery)	4.3 lbs.
Shipping Weight	4.3 lbs.



LXT

DUB182T1

DUB182Z

18V LXT® Blower Kit

- Variable speed (0-18,000 RPM) for optimum speed control
- Up to 20 minutes of continuous operation at high speed with a 5.0Ah LXT® battery
- Compact and ergonomic design at only 20-3/4" long
- Weighs only 3.9 lbs. with battery for reduced operator fatigue
- Rubberized soft grip handle for increased operator comfort
- Makita-built variable 3-speed motor produces a maximum air velocity of 179 MPH

DUB182T1 Includes: 18V LXT® Blower (DUB182Z), 18V LXT® Lithium-Ion 5.0Ah Battery (BL1850B), 18V LXT® Lithium-Ion Rapid Optimum Charger (DC18RC), Rubber Blower Nozzle (132025-7), 20" Contractor Tool Bag (831303-9)

DUB182Z Includes: Tool only, battery & charger not included Rubber Blower Nozzle (132025-7)

Max. Air Volume	91 CFM
Max. Air Velocity	179 MPH
No Load Speed (variable speed)	0 - 18,000 RPM
Battery	18V LXT® Lithium-Ion
Overall Length	20-3/4"
Net Weight (with battery)	3.9 lbs.
Shipping Weight	10.8 lbs.



LXT BRUSHLESS

XR09PT

XR09Z

18V X2 (36V) LXT® Brushless String Trimmer Kit

- Makita-built Outer Rotor BL™ Brushless Motor direct-drive system provides high power and increased torque
- 2-speed options (Low: 5,000 RPM, High: 6,500 RPM) allows the operator to match speed to application
- Delivers up to 60 minutes of run time under load on the low speed setting using two 18V LXT® 5.0Ah BL1850 batteries
- Bump and Feed trimmer head rotates the same counterclockwise direction as professional grade trimmers
- Accepts industry standard spindles M10x1.25 LH for more convenience

XR09PT Includes: 18V X2 (36V) LXT® Brushless String Trimmer (XR09Z), Bump & Feed Trimmer Head, M10 X 1.25 LH (197296-3), (2) 18V LXT® Lithium-Ion 5.0Ah Battery (BL1850B)

XR09Z Includes: Tool only, battery & charger not included

Cutting Capacity (diameter)	13-3/4"
No Load Speed (2 spd)	5,000/6,500 RPM
Battery	2X 18V LXT® Lithium-Ion
Overall Length	69"
Net Weight (with battery)	9.9 lbs.
Shipping Weight	18.8 lbs.



LXT BRUSHLESS

XR11M1

XR11Z

18V LXT® Brushless String Trimmer Kit

- Up to 30 minutes of run time with 4.0Ah battery under load on the high setting
- BL™ Brushless motor delivers up to 6,000 RPM for faster cutting
- Automatic Torque Drive Technology automatically shifts from 4,000-6,000 RPM depending on density of application
- 3-speed options (Low: 4,000 RPM, Medium: 5,000 RPM, High: 6,000 RPM) allows the operator to match speed to application
- 11-3/4" cutting swath for user convenience

XR11M1 Includes: 18V LXT® Brushless String Trimmer (XR11Z), 18V LXT® Lithium-Ion 4.0Ah Battery (BL1840B), 18V LXT® Lithium-Ion Rapid Optimum Charger (DC18RC), Shoulder Strap, Safety Goggles

XR11Z Includes: Tool only, battery & charger not included Bump & Feed Trimmer Head, M8 X 1.25 LH (198386-5), Shoulder Strap (125516-5), Goggles (195246-2), Hex Wrench (783217-7), Hex Wrench (783202-0), Accessory Bag (831304-7)

Cutting Capacity (diameter)	11-3/4"
No Load Speed (2 spd)	4,000/6,000 RPM
Battery	18V LXT® Lithium-Ion
Overall Length	70-1/2"
Net Weight (with battery)	7.4 lbs.
Shipping Weight	14.7 lbs.



LXT BRUSHLESS

XR13Z

18V LXT® Brushless Curved Shaft String Trimmer

- Automatic Speed Change™ technology automatically adjusts cutting speed (4,000-6,000 RPM) and torque depending on density of application
- Manual operation mode features 3-speed options (Low: 4,000 RPM, Medium: 5,000 RPM, High: 6,000 RPM) allows the operator to match speed to application
- Telescoping curved shaft adjusts (59-1/2" - 63-1/2" length) for convenient operation in tight places
- BL™ Brushless motor delivers up to 6,000 RPM for faster cutting
- Up to 38 minutes of run time on high setting and 103 minutes on low setting under load using 18V LXT® 5.0Ah battery BL1850B (battery not included)
- 11-3/4" cutting swath for user convenience

XR13Z Includes: Tool only, battery & charger not included Shoulder Strap (125516-5), Trimmer Head

Shipping Weight	10.12 lbs.
Voltage	18V
Brushless Motor	Yes
Arbor Shaft	M8 x 1.25 RH
No Load Speed (3 spd)	4,000/5,000/6,000 RPM



LXT

XR00Z

18V LXT® String Trimmer

- Up to 60 minutes of run time under no load using 5.0Ah battery BL1850B (battery not included)
- Telescoping shaft (48-1/2" to 56-1/2") for optimum cutting position
- Makita-built motor delivers 7,800 RPM for faster cutting
- Adjustable 5-position pivoting head for cutting angle adjustment when trimming in tight spaces
- 180° rotating head allows the trimmer to convert to edger; 10-1/4" cutting width
- Weighs only 6.4 lbs. with battery (battery not included) for reduced operator fatigue

XR00Z Includes: Tool only, battery & charger not included Bump & Feed Trimmer Head (195858-1)

Cutting Capacity (diameter)	10-1/4"
No Load Speed	7,800 RPM
Battery	18V LXT® Lithium-Ion
Overall Length	56-1/2"
Net Weight (with battery)	6.4 lbs.
Shipping Weight	8.8 lbs.

ULTIMATE VERSATILITY

COUPLE SHAFT POWER HEADS & ATTACHMENTS

COUPLE SHAFT SYSTEM

The Makita® Couple Shaft Series has multiple attachments that are fully compatible with the gas engine or cordless powerhead. Users benefit with the increased efficiency and reduced tool costs of running one powerhead system for multiple applications.



PICK YOUR POWER

PICK YOUR ATTACHMENT

See pg. 120 for full attachment listing

CORDLESS

18V X2 (36V) LXT® Brushless Couple Shaft Power Head

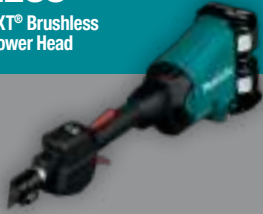

CORDLESS BENEFITS



NO GAS
NO MIXING



INSTANT
STARTS



REDUCED
MAINTENANCE

4-STROKE

25.4 cc MM4® 4-Stroke Couple Shaft Power Head



See pg. 116

4-STROKE BENEFITS



NO OIL
MIXING



REDUCED
EMISSIONS



LXT BRUSHLESS

X2 18V + 18V = 36V



LXT BRUSHLESS

XUX01Z

18V X2 (36V) LXT® Brushless Couple Shaft Power Head

- BL™ Brushless motor delivers up to 9,700 RPM
- 3-speed options (Low: 5,700 RPM, Medium: 8,200 High: 9,700 RPM) allows the operator to match speed to application
- Compatible with a variety of optional couple shaft attachments for versatility
- Lever style lock system allows for quick tool-less installation and replacement of attachments
- Electronic Torque Control turns the motor off if rotation speed suddenly slows or wheel is forced to stop

XUX01Z Includes: Tool only, battery & charger not included Shoulder Strap (125516-5)



XUX01Z

XUX01M5PT

18V X2 (36V) LXT® Brushless Couple Shaft Power Head Kit with Trimmer Attachment

- BL™ Brushless motor delivers up to 9,700 RPM for faster cutting
- 3-speed options (Low: 5,700 RPM, Medium: 8,200 High: 9,700 RPM) allow the operator to match speed to application
- Compatible with a variety of optional couple shaft attachments for versatility
- Lever style lock system allows for quick tool-less installation and replacement of attachments
- Electronic Torque Control turns the motor off if rotation speed suddenly slows down or stops
- Reverse (clockwise) rotation system allows operator to quickly clear brush cutter head of entangled grass and weeds
- Variable speed trigger switch for controlled cutting speed
- The BL™ Brushless Motor eliminates carbon brushes, enabling the BL™ Motor to run cooler and more efficiently for longer life

XUX01M5PT Includes: 18V X2 (36V) LXT® Brushless Couple Shaft Power Head (XUX01Z), String Trimmer Couple Shaft Attachment (EM405MP), 18V LXT® Lithium-Ion Dual Port Charger (DC18RD), (2) 18V LXT® Lithium-Ion 5.0Ah Battery (BL1850B), Shoulder Strap (125516-5), 46" Contractor Tool Bag (195638-5)

XUX01Z Includes: Tool only, battery & charger not included Shoulder Strap (125516-5)

Cutting Capacity (diameter)	17"
No Load Speed (var. 3 spd.)	0 - 9,700 / 0 - 8,200 / 0 - 5,700 RPM
Battery	2X 18V LXT® Lithium-Ion
Overall Length	69"
Net Weight (with battery)	17.2 lbs.
Shaft Type	Multi-tool attachment
Shipping Weight	31.1 lbs.

Shaft Type	Multi-tool attachment
No Load Speed (var. 3 spd.)	0 - 9,700 / 0 - 8,200 / 0 - 5,700 RPM
Battery	2X 18V LXT® Lithium-Ion
Overall Length	39-3/4"
Net Weight (with battery)	9.8 lbs.
Shipping Weight	10.6 lbs.

SPEED

3-speed options (up to 9,700 RPM) allows the operator to match speed to application



COMPATIBILITY

Compatible with a variety of optional couple shaft attachments for versatility

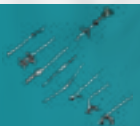

DESIGN

Lever style lock system allows for quick tool-less installation and replacement of attachments

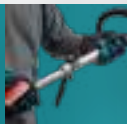

LXT BRUSHLESS

XHU07T **XHU07Z**

18V LXT® Brushless 24" Hedge Trimmer Kit

- 5-position rotating rear handle for increased comfort during vertical and angle trimming
- 3-speed options (Low: 2,000 SPM, Medium: 3,600 SPM, High: 4,400 SPM) allowing the operator to match speed to application
- Variable speed trigger for increased operator control
- Anti-vibration design aids in precision cutting
- 24" blade provides increased cutting capacity
- Features Extreme Protection Technology (XPT™) which is engineered to provide increased dust and water resistance in harsh job site conditions

XHU07T Includes: (2) 18V LXT® Lithium-Ion 5.0Ah Battery (BL1850B), 18V LXT® Lithium-Ion Rapid Optimum Charger (DC18RC), Hedge Trimmer Blade Cover

XHU07Z Includes: Tool only, battery & charger not included Hedge Trimmer Blade Cover

Blade Length	24"
Strokes Per Minute	4,400 SPM
Overall Length	44-1/4"
Battery	18V LXT® Lithium-Ion
Net Weight (without battery)	7.3 lbs.

LXT BRUSHLESS

XHU08T **XHU08Z**

18V LXT® Brushless 30" Hedge Trimmer Kit

- 5-position rotating rear handle for increased comfort during vertical and angle trimming
- 3-speed options (Low: 2,000 SPM, Medium: 3,600 SPM, High: 4,400 SPM) allowing the operator to match speed to application
- Variable speed trigger for increased operator control
- Anti-vibration design aids in precision cutting
- 30" blade provides increased cutting capacity
- Features Extreme Protection Technology (XPT™) which is engineered to provide increased dust and water resistance in harsh job site conditions

XHU08T Includes: (2) 18V LXT® Lithium-Ion 5.0Ah Battery (BL1850B), 18V LXT® Lithium-Ion Rapid Optimum Charger (DC18RC), Hedge Trimmer Blade Cover

XHU08Z Includes: Tool only, battery & charger not included Hedge Trimmer Blade Cover

Blade Length	30"
Strokes Per Minute	4,400 SPM
Overall Length	49-3/4"
Battery	18V LXT® Lithium-Ion
Net Weight (without battery)	7.7 lbs.

LXT X2 18V + 18V 36V

XHU04PT **XHU04Z**

18V X2 (36V) LXT® 25-1/2" Hedge Trimmer Kit

- Delivers up to 60 minutes of run time on high setting under load using two 5.0Ah BL1850B batteries
- 6 speed dial (0 - 1,800 SPM) allows the user to match the speed to the application
- 25-1/2" blade provides increased cutting capacity
- 5-position rotating rear handle for increased comfort during vertical and angle trimming
- Makita-built motor delivers 1,800 SPM for faster cutting
- Lower noise level at only 86.5 dB(A); up to 30% quieter than gas

XHU04PT Includes: 18V X2 (36V) LXT® 25-1/2" Hedge Trimmer (XHU04Z), (2) 18V LXT® Lithium-Ion 5.0Ah Battery (BL1850B), 18V LXT® Lithium-Ion Dual Port Charger (DC18RD), Blade Cover (1)

XHU04Z Includes: Tool only, battery & charger not included Blade Cover

Blade Length	25-1/2"
Strokes Per Minute	1,800 SPM
Battery	2X 18V LXT® Lithium-Ion
Overall Length	48-3/4"
Net Weight (with battery)	12.2 lbs.
Shipping Weight	21.4 lbs.

LXT

XHU02M1 **XHU02Z**

Includes one battery

18V LXT® 22" Hedge Trimmer Kit

- Up to 120 minutes of run time under no load using 4.0Ah battery BL1840B on lowest setting
- Makita-built motor delivers 1,350 SPM for increased cutting speed
- 22" blade provides increased cutting capacity
- Anti-vibration design (five cushions within the motor housing) helps minimize vibration
- Battery capacity warning system; motor stops and light goes on indicating battery needs recharging
- Lower noise level at only 87 dB(A) for operator comfort

XHU02M1 Includes: 18V LXT® 22" Hedge Trimmer (XHU02Z), 18V LXT® Lithium-Ion 4.0Ah Battery (BL1840B), 18V LXT® Lithium-Ion Rapid Optimum Charger (DC18RC), Blade Cover

XHU02Z Includes: Tool only, battery & charger not included Blade Cover (450490-1)

Blade Length	22"
Strokes Per Minute	1,350 SPM
Battery	18V LXT® Lithium-Ion
Overall Length	38"
Net Weight (with battery)	7.4 lbs.
Shipping Weight	12.8 lbs.

LXT

XMU04Z

18V LXT® Grass Shear

- Makita-built motor delivers 2,500 SPM for efficient cutting
- Up to 200 minutes of run time with 5.0Ah battery BL1850B (battery not included)
- 6-5/16" cutting width for optimum performance
- Dual blade action cuts with a shearing effect for improved results
- Easy to operate 3 stage cutting height adjustment (19/32", 25/32", 1")
- "Tool-less" blade changing system for increased convenience

XMU04Z Includes: Tool only, battery & charger not included Blade Guard, Grass Receiver

Cutting Capacity (width)	6-5/16"
Depth Adjustment Range	9/32", 25/32", 1"
Strokes Per Minute	2,500 SPM
Battery	18V LXT® Lithium-Ion
Overall Length	13-7/8"
Net Weight (with battery)	4.1 lbs.
Shipping Weight	3.6 lbs.

LXT X2 18V + 18V 36V

XML02PT **XML02Z**

18V X2 (36V) LXT® 17" Cordless Lawn Mower Kit

- Delivers up to 30 minutes of run time using two 18V LXT® 5.0Ah BL1850 batteries
- Makita-built motor delivers 3,600 RPM for faster and powerful cutting
- Easy to operate lever for quick adjustment of 13 cutting heights (13/16" - 2-5/16")
- Soft start suppresses start-up reaction for smooth start-ups and longer gear life
- 17" cutting width for optimum performance
- Grass catcher bag holds up to 13 gallons of grass

XML02PT Includes: 18V X2 (36V) LXT® 17" Lawn Mower (XML02Z), (2) 18V LXT® Lithium-Ion 5.0Ah Battery (BL1850B), 18V LXT® Lithium-Ion Dual Port Charger (DC18RD), Grass Catcher Bag (126621-1)

XML02Z Includes: Tool only, battery & charger not included Grass Catcher Bag (126621-1)

Cutting Capacity (width)	17"
Cutting Capacity (height range)	13/16" - 2-5/16"
No Load Speed	3,600 RPM
Battery	2X 18V LXT® Lithium-Ion
Dimensions (LxWxH)	58-3/4" x 18-1/8" x 37-1/2"
Net Weight (with battery)	40.8 lbs.
Shipping Weight	

LXT BRUSHLESS

XUC01PTX1 **XUC01X1**

18V X2 LXT® Brushless Power-Assisted Wheelbarrow Kit

- Delivers up to 45 minutes of run time under load using one 18V LXT® 5.0Ah battery
- Holds (2) 18V LXT® Lithium-Ion batteries but operates using (1) 18V battery at a time; utilizes second battery when needed
- Makita-built BL™ Brushless Motor for optimal performance
- 2-speed with maximum speed up to 2.5 MPH on a 12° incline
- Reversible for versatility and convenience

XUC01PTX1 Includes: 18V X2 LXT® Brushless Power-Assisted Hand Truck/Wheelbarrow (XUC01Z), (2) 18V LXT® Lithium-Ion 5.0Ah Battery (BL1850B), 18V LXT® Lithium-Ion Dual Port Charger (DC18RD), Steel Bucket (198494-2), L-Shaped Legs, (2) Rear Wheel

XUC01X1 Includes: Tool only, battery & charger not included 18V X2 LXT® Brushless Power-Assisted Hand Truck/Wheelbarrow (XUC01Z), Steel Bucket (198494-2), L-Shaped Legs, (2) Rear Wheel

Speed Forward (High/Low MPH)	2.5 / 1 MPH
Speed Reverse (MPH)	.62 MPH
Max. Load Capacity	275 lbs.
Max. Grade	12°
Battery	2X 18V LXT® Lithium-Ion
Dimensions (LxWxH)	43-3/4" x 23-1/4" x 32-1/4"
Net Weight	87.2 lbs.
Shipping Weight	125 lbs.

LXT BRUSHLESS

XUC01PTX2 **XUC01X2**

18V X2 LXT® Brushless Power-Assisted Flat Dolly Kit

- Delivers up to 45 minutes of run time under load using one 18V LXT® 5.0Ah battery
- Holds (2) 18V LXT® Lithium-Ion batteries but operates using (1) 18V battery at a time; utilizes second battery when needed
- Makita-built BL™ Brushless Motor for optimal performance
- 2-speed with maximum speed up to 2.5 MPH on a 12° incline
- Reversible for versatility and convenience
- Interchangeable steel tube flat bed or steel bucket (steel bucket optional)

XUC01PTX2 Includes: 18V X2 LXT® Brushless Power-Assisted Hand Truck/Wheelbarrow (XUC01Z), (2) 18V LXT® Lithium-Ion 5.0Ah Battery (BL1850B), 18V LXT® Lithium-Ion Dual Port Charger (DC18RD), Flatbed Pipe Frame (199116-7), L-Shaped Legs, (2) Rear Wheel

XUC01X2 Includes: Tool only, battery & charger not included 18V X2 LXT® Brushless Power-Assisted Hand Truck/Wheelbarrow (XUC01Z), Flatbed Pipe Frame (199116-7), L-Shaped Legs, (2) Rear Wheel

Speed Forward (High/Low MPH)	2.5 / 1 MPH
Speed Reverse (MPH)	.62 MPH
Max. Load Capacity	275 lbs.
Max. Grade	12°
Battery	2X 18V LXT® Lithium-Ion
Dimensions (LxWxH)	43-3/4" x 26-3/8" x 32-1/4"
Net Weight	98.2 lbs.
Shipping Weight	136 lbs.



**STRAIGHT GAS,
NO OIL MIXING**



NO OIL
MIXING



REDUCED
EMISSIONS

MM4® 4-stroke unleashes your potential so you can power through jobs without hesitation. No oil mixing, lower costs and reduced emissions mean less stress and more savings. Power and efficiency are on your side—how will you rule the outdoors?

4-STROKE FEATURES

- Less costs with improved fuel efficiency and no 2-stroke oil
- Reduced emissions for cleaner operation
- Fast and easy starts with mechanical automatic engine decompression
- Higher engine torque delivers the power and performance needed to meet the demands of the professional



LEARN MORE
MAKITATools.COM/OPE/4STROKE

NO FUEL MIX NEEDED

PERFORMANCE

High Air Volume (706 CFM) and Air Speed (206 MPH) for Commercial Duty Performance

EFFICIENCY

Mechanical automatic engine decompression for quick and easy starts



EB7660TH

75.6 cc MM4® 4-Stroke Engine Tube Throttle Backpack Blower

- Powerful fuel efficient 75.6 cc (3.8 HP) MM4® commercial duty engine
- Mechanical automatic engine decompression for quick and easy starts
- Shoulder straps engineered with multiple adjustments for improved fit
- Tool-less handle adjustment for quick positioning of handle
- Padded back panel is ventilated for improved operator comfort
- Heavy duty anti-vibration mounts between frame and engine for improved operator comfort
- Tool-less handle adjustment for quick positioning of handle
- Adjustable tube easily adjusts to desired length
- Large handle positioned at optimum center of gravity for easier transport
- Large capacity muffler ensures quieter operation (76 dBA)
- Padded shoulder straps retain their shape for easier re-shouldering

EB7660TH Includes: End Nozzle (454896-5), End Nozzle (455128-3), Flat End Nozzle (454916-5)

Engine Displacement (cc)	75.6 cc
Engine (HP)	3.8 HP
Max. Air Volume	706 CFM
Max. Air Velocity	206 MPH
Fuel Type	Unleaded gas
Fuel Tank Capacity	64 oz.
Crank Case Capacity	7.4 oz.
Sound Pressure	76 dB(A)
Dry Weight	24.1 lbs.
Shipping Weight	31.1 lbs.



EB7660WH

75.6 cc MM4® 4-Stroke Engine Hip Throttle Backpack Blower

- Powerful fuel efficient 75.6 cc (3.8 HP) MM4® commercial duty engine
- Mechanical automatic engine decompression for quick and easy starts
- Hip throttle with cruise control and convenient on/off switch
- Shoulder straps engineered with multiple adjustments for improved fit

EB7660WH Includes: End Nozzle (454896-5), End Nozzle (455128-3), Flat End Nozzle (454916-5)

Engine Displacement (cc)	75.6 cc
Engine (HP)	3.8 HP
Max. Air Volume	706 CFM
Max. Air Velocity	206 MPH
Fuel Type	Unleaded gas
Fuel Tank Capacity	64 oz.
Crank Case Capacity	7.4 oz.
Sound Pressure	76 dB(A)
Dry Weight	24.5 lbs.
Shipping Weight	32.4 lbs.



EB5300TH

52.5 cc MM4® 4-Stroke Engine Tube Throttle Backpack Blower

- Mechanical automatic engine decompression for quick and easy starts
- Shoulder straps engineered with multiple adjustments for improved fit
- Tool-less handle adjustment for quick positioning of handle
- Powerful fuel efficient 52.5 cc (2.5 HP) MM4® commercial duty engine

EB5300TH Includes: End Nozzle (454896-5), End Nozzle (455128-3), Flat End Nozzle (454916-5)

Engine Displacement (cc)	52.5 cc
Engine (HP)	2.5 HP
Max. Air Volume	516 CFM
Max. Air Velocity	184 MPH
Fuel Type	Unleaded gas
Fuel Tank Capacity	60.9 oz.
Crank Case Capacity	4.7 oz.
Sound Pressure (per Ansi B175.2 standard)	70 dB(A)
Dry Weight	19.7 lbs.
Shipping Weight	26.5 lbs.



EB5300WH

52.5 cc MM4® 4-Stroke Engine Hip Throttle Backpack Blower

- Mechanical automatic engine decompression for quick and easy starts
- Shoulder straps engineered with multiple adjustments for improved fit
- Tool-less handle adjustment for quick positioning of handle
- Powerful fuel efficient 52.5 cc (2.4 HP) MM4® commercial duty engine

EB5300WH Includes: End Nozzle (454896-5), End Nozzle (455128-3), Flat End Nozzle (454916-5)

Engine Displacement (cc)	52.5 cc
Engine (HP)	2.5 HP
Max. Air Volume	516 CFM
Max. Air Velocity	184 MPH
Fuel Type	Unleaded gas
Fuel Tank Capacity	60.9 oz.
Crank Case Capacity	4.7 oz.
Sound Pressure (per Ansi B175.2 standard)	70 dB(A)
Dry Weight	20.1 lbs.
Shipping Weight	27.8 lbs.



BHX2500CA

24.5 cc MM4® 4-Stroke Engine Blower

- Mechanical Automatic Engine Decompression for quicker, easier starts
- Soft grip for less vibration and convenient cruise control lever
- Dual stage air filter is replaceable and easily accessible
- Compact design with less weight (only 9.8 lbs.)
- Large capacity muffler ensures quieter operation at 67dB(A)
- Powerful and fuel efficient 24.5 cc 4-stroke commercial duty engine

BHX2500CA Includes: Blower Extension Tube (125729-8), Round End Blower Nozzle (450966-8), Tool Kit (690-90590-00)

Engine Displacement (cc)	24.5 cc
Engine (HP)	1.1 HP
Max. Air Volume	356 CFM
Max. Air Velocity	145 MPH
Fuel Type	Unleaded gas
Fuel Tank Capacity	17.6 oz.
Crank Case Capacity	2.7 oz.
Sound Pressure	67 dB(A)
Dry Weight	9.8 lbs.
Shipping Weight	10 lbs.



PM7650H

75.6 cc MM4® 4-Stroke Engine Mist Blower

- L-shaped chemical tank lowers center of gravity for improved balance
- Single action switch to activate liquid chemical flow
- Liquid chemical in tank is automatically mixed by intake air flow for uniform solution concentration
- Powerful fuel efficient 75.6 cc (3.67 HP), MM4® 4-stroke, commercial duty engine
- Mechanical automatic engine decompression for quick and easy start-ups

PM7650H Includes: Nozzle Set (196499-6), Box Wrench (782237-8), Diffusion Cover (453506-1), Driver (783019-1)

Engine Displacement (cc)	75.6 cc
Engine Power	3.67 HP
Tank	3.9 gal.
Max. Air Volume	496 CFM
Max. Air Velocity	190 MPH
Fuel Type	Unleaded gas
Fuel Tank Capacity	64 oz.
Crank Case Capacity	7.4 oz.
Sound Pressure	74 dB(A)
Dry Weight	29.3 lbs.
Shipping Weight	36.6 lbs.



EM2650LH

25.4 cc MM4® 4-Stroke Engine String Trimmer

- High capacity, rapid loading, bump-and-feed trimmer head
- Ergonomically designed rubberized soft grip provides more comfort
- Heavy duty, dual stage air filter with large sealing areas is replaceable and easily accessible.
- Compact design with less weight (only 10.9 lbs.)
- Ergonomic loop handle

EM2650LH Includes: Bump & Feed Trimmer Head, M10 X 1.25 LH (T-01753A), 4-Cycle Engine Oil, 10W-30, 2.7 oz. (195826-4), Wrench 4 (783223-2), Protector Set (196117-6)

Engine Displacement (cc)	25.4 cc
Engine (HP)	1.1 HP
Cutting Capacity (diameter)	17"
Power Type	4-stroke gas
Fuel Type	Unleaded gas
Fuel Tank Capacity	20.3 oz.
Crank Case Capacity	2.7 oz.
Arbor Shaft	M10 x 1.25 LH
Dry Weight	10.9 lbs.
Shipping Weight	20.85 lbs.



EM2652LHN

25.4 cc MM4® 4-Stroke Engine High Torque String Trimmer

- High capacity, rapid loading, bump-and-feed trimmer head
- Steel drive shaft engineered for less vibration and longer equipment life
- Powerful and fuel efficient 25.4 cc 4-stroke commercial duty engine
- Compact design with less weight (only 11.5 lbs.)

EM2652LHN Includes: Bump & Feed Trimmer Head, M10 X 1.25 LH (T-01753A), 4-Cycle Engine Oil, 10W-30, 2.7 oz. (195826-4)

Engine Displacement (cc)	25.4 cc
Engine (HP)	1.1 HP
Cutting Capacity (diameter)	17"
Power Type	4-stroke gas
Fuel Type	Unleaded gas
Fuel Tank Capacity	20.3 oz.
Crank Case Capacity	2.7 oz.
Arbor Shaft	M10 x 1.25 LH
Dry Weight	11.5 lbs.
Shipping Weight	18 lbs.



EM2650UH

25.4 cc MM4® 4-Stroke Engine Brush Cutter

- Steel drive shaft for less vibration and longer equipment life
- Easily adjustable handle configuration
- Flexible universal guard for both saw blade and nylon cutting head
- Ergonomically designed rubberized soft grip provides more control and comfort
- Compact design with less weight (only 12.1 lbs.)

EM2650UH Includes: 9" Star Blade, 4T (B-14118), Brush Cutter Harness (123143-2), 4-Cycle Engine Oil, 10W-30, 2.7 oz. (195826-4)

Engine Displacement (cc)	25.4 cc
Engine (HP)	1.1 HP
Blade Diameter	9"
Power Type	4-stroke gas
Fuel Type	Unleaded gas
Fuel Tank Capacity	20.3 oz.
Crank Case Capacity	2.7 oz.
Arbor Shaft	M10 x 1.25 LH
Dry Weight	12.1 lbs.
Shipping Weight	17 lbs.



EE2650H

25.4 cc MM4® 4-Stroke Engine Edger

- 8" steel blade for precise cuts and longer blade life
- Adjustable wheel for quick and easy adjustment to desired cutting depth
- Metal skid plate protects gear housing for increased durability
- Steel drive shaft engineered for reduced vibration and longer life
- Guide marking on blade guard allows for cleaner more precise cuts
- Heavy duty dual-stage air filter with large sealing areas is easily accessible

EE2650H Includes: Blade (196745-7)

Engine Displacement (cc)	25.4 cc
Engine (HP)	1.1 HP
Blade Length	8"
Arbor	1"
Fuel Type	Unleaded gas
Fuel Tank Capacity	20 oz.
Crank Case Capacity	2.7 oz.
Overall Length	69-3/4"
Dry Weight	14.4 lbs.
Shipping Weight	20.3 lbs.

4-STROKE POWERED



PERFORMANCE

Powerful and fuel efficient 25.4 cc multi-position 4-stroke engine



DURABILITY

Heavy duty, dual stage air filter with large sealing areas and "Tool-less" filter access



VERSATILITY

Multi-position lubrication system enables continuous operation at any engine angle



NEW EX2650LH

25.4 cc MM4® 4-Stroke Couple Shaft Power Head

EX2650LH Includes: Hex Wrench (783202-0)

- Quick release couple shaft attachment for use with multiple attachments
- Ergonomically designed rubberized soft grip provides more comfort
- Heavy duty, dual stage air filter with large sealing areas is replaceable and easily accessible.
- Compact design with less weight
- Ergonomic loop handle
- Compact design with less weight
- Oil filling port and drain plug are easily accessible with oil level view window for easy checking and replacing of oil
- Steel drive shaft for less vibration and longer equipment life
- Easily adjustable handle configuration for improved balance
- Translucent fuel tank with large opening for easier refueling

Engine Displacement (cc)	25.4 cc
Engine (HP)	1.1 HP
Power Type	4-stroke gas
Fuel Type	Unleaded gas
Fuel Tank Capacity	20.3 oz.
Crank Case Capacity	2.7 oz.
Dry Weight	10 lbs.
Shipping Weight	15 lbs.

EN4950H

20" 25.4 cc MM4® 4-Stroke Engine Articulating Hedge Trimmer

- Steel drive shaft for less vibration and longer equipment life
- 20" double-sided blade with high blade speed (4,200 SPM) for efficient cutting
- Angle change lever quickly and easily adjusts blade angle
- Powerful fuel efficient 25.4 cc (1.1 HP), MM4® commercial duty engine
- Heavy duty dual stage air filter with large sealing areas is replaceable and easily accessible

EN4950H Includes: Shear Blade (725187-4), Blade Cover (452328-6)

Engine Displacement (cc)	25.4 cc
Engine (HP)	1.1 HP
Blade Length	20"
Blade Speed	4,200 SPM
Fuel Type	Unleaded gas
Fuel Tank Capacity	20.3 oz.
Crank Case Capacity	2.7 oz.
Overall Length	99"
Dry Weight	15.6 lbs.
Shipping Weight	22 lbs.

4-STROKE GAS / ELECTRIC POWER EQUIPMENT

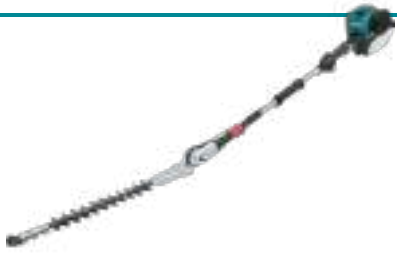

EN4951SH

20" 25.4 cc MM4® 4-Stroke Engine Articulating Hedge Trimmer

- 180° blade adjustment allows blade to be positioned along shaft for convenient transport and storage
- Steel drive shaft for less vibration and longer equipment life
- Angle change lever quickly and easily adjusts blade angle
- Powerful fuel efficient 25.4 cc (1.1 HP), MM4® commercial duty engine
- 20" double-sided blade with high blade speed (4,200 SPM) for efficient cutting

EN4951SH Includes: Blade Cover (454279-9), Shear Blade (725187-4)

Engine Displacement (cc)	25.4 cc
Engine (HP)	1.1 HP
Blade Length	20"
Blade Speed	4,200 SPM
Fuel Type	Unleaded gas
Fuel Tank Capacity	20.3 oz.
Crank Case Capacity	2.7 oz.
Overall Length	80-1/2"
Dry Weight	14.6 lbs.
Shipping Weight	21.6 lbs.



EN5950SH

24" 25.4 cc MM4® 4-Stroke Engine Double-Sided Hedge Trimmer

- Compact design with less weight (only 14.1 lbs.)
- Commercial duty gear case engineered for improved durability
- Tip guard protects blade from unnecessary wear
- Powerful and fuel efficient 25.4 cc (1.1 HP), MM4® commercial duty engine

EN5950SH Includes: Shear Blade (725184-0), Blade Cover (454278-1)

Engine Displacement (cc)	25.4 cc
Engine (HP)	1.1 HP
Blade Length	24"
Blade Speed	4,200 SPM
Fuel Type	Unleaded gas
Fuel Tank Capacity	20.3 oz.
Crank Case Capacity	2.7 oz.
Overall Length	71-1/4"
Dry Weight	14.1 lbs.
Shipping Weight	20 lbs.

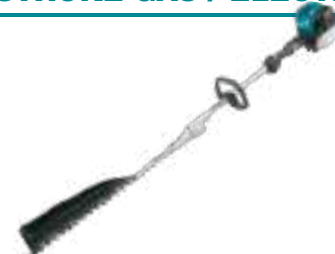

EN7350SH

30" 25.4 cc MM4® 4-Stroke Engine Single-Sided Hedge Trimmer

- Chip receiver for efficient collection and clean-up of clippings
- Steel drive shaft for less vibration and longer equipment life
- Powerful fuel efficient 25.4 cc (1.1 HP), MM4® commercial duty engine
- Compact design with less weight (only 14.7 lbs.)

EN7350SH Includes: Shear Blade A (725185-8), Shear Blade B (725186-6), Blade Cover (451868-1)

Engine Displacement (cc)	25.4 cc
Engine (HP)	1.1 HP
Blade Length	30"
Blade Speed	4,200 SPM
Fuel Type	Unleaded gas
Fuel Tank Capacity	20.3 oz.
Crank Case Capacity	2.7 oz.
Overall Length	76-3/4"
Dry Weight	14.7 lbs.
Shipping Weight	20 lbs.



EY2650H25H

25.4 cc MM4® 4-Stroke Engine Telescoping Pole Pruner

- Telescoping shaft easily adjusts from 8 ft. to 13 ft.
- Reduced cutting head weight for improved balance and reduced operator fatigue
- Translucent bar oil tank with automatic chain lubrication for efficient operation
- Oil view window for convenient checking of engine oil level
- Heavy duty dual-stage air filter with large sealing areas is easily accessible

EY2650H25H Includes: 10" GUIDE BAR (165695-7), CHAIN PROTECTOR (452093-7), 10" SAW CHAIN (196142-7), BAND ASSEMBLY (125516-5)

Engine Displacement (cc)	25.4 cc
Engine (HP)	1.1 HP
Overall Length	154-1/2"
Guide Bar Length	10"
Fuel Type	Unleaded gas
Fuel Tank Capacity	20 oz.
Crank Case Capacity	2.7 oz.
Dry Weight	16 lbs.
Shipping Weight	24 lbs.

CORDED POWER EQUIPMENT



25" UH6570 shown

UH6570 / UH5570

25" / 22" Electric Hedge Trimmer

- Low motor noise level for quiet operation
- Well balanced and with less weight
- Two-hand operation switch, motor runs only when grips are held with both hands
- Large, transparent hand guard permits a good view of the work area
- Ergonomic grip design for improved comfort and handling
- Engineered for lower vibration and increased user comfort

UH6570 Includes: 25" Hedge Trimmer Blade (194669-1), Hedge Trimmer Blade Cover (450490-1), Cord Hook (158024-1), Cord Holder (194677-2)

UH5570 Includes: 22" Hedge Trimmer Blade (194665-9), Hedge Trimmer Blade Cover (450490-1), Cord Hook (158024-1), Cord Holder (194677-2)

Capacity (cutting diameter)	1/2"
Capacity (cutting length):	UH6570 (25-1/2"), UH5570 (21-5/8")
Blade Speed	1,600 SPM
AMPS	4.8
Overall Length:	UH6570 (44-3/4"), UH5570 (40-1/2")
Net Weight:	UH6570 (8.2 lbs.), UH5570 (7.9 lbs.)
Shipping Weight:	UH6570 (10.7 lbs.), UH5570 (10.5 lbs.)



UC4051A

16" Electric Chain Saw

- "Tool-less" blade and chain adjustments for convenient operation and easy maintenance
- Rubberized grip handles are ergonomically designed for comfort
- Built-in current limiter helps protect motor from burnout
- Large oil reservoir with view window allows operator to check bar oil level

UC4051A Includes: 16" Saw Chain, 3/8", .050" (196208-3), 16" Guide Bar, 3/8", .050" (442-040-661), 18" Chain Cover (952-010-640)

UC3551A Includes: 14" Saw Chain, 3/8", .050" (196207-5), 14" Guide Bar, 3/8", .050" (165201-8), 14" Chain Cover (952-010-630)

Chain Speed	2,900 FPM
Guide Bar Length	16"
Pitch	3/8"
Gauge	.050"
Oil Tank Capacity	6.8 oz.
Overall Length	19-7/8"
Net Weight (w/o bar & chain)	12.3 lbs.
Shipping Weight	15.7 lbs.



UC3551A

14" Electric Chain Saw

- "tool-less" blade and chain adjustments
- Built-in current limiter helps protect motor
- Large oil reservoir with view window allows operator to check oil level
- Rubberized grip handles are ergonomically designed
- Large trigger switch with soft start for smooth start-ups
- Automatic chain oiler for heavy continuous cutting

UC3551A Includes: 14" Saw Chain, 3/8", .050" (196207-5), 14" Guide Bar, 3/8", .050" (165201-8), 14" Chain Cover (952-010-630)

Chain Speed	2,900 FPM
Guide Bar Length	14"
Pitch	3/8"
Gauge	.050"
Oil Tank Capacity	6.8 oz.
Overall Length	19-7/8"
Net Weight (w/o bar & chain)	12.1 lbs.
Shipping Weight	16.5 lbs.



UB1103

Blower

- Variable speed control dial and trigger (0-16,000 RPM) for increased performance
- Maximum air volume of 145 cfm for faster clean up in larger areas
- Two tools in one: quickly converts to a vacuum for added versatility
- Large trigger with conveniently located lock-on button
- Ergonomic handle designed for increased operator comfort
- Optional long nozzle available (part no. 134182-7) for harder to reach areas

UB1103 Includes: Rubber Blower Nozzle (132025-7), Dust Bag (123241-2)

AMPS	6.8
Max. Air Volume	145 CFM
Max. Air Velocity	203 MPH
No Load Speed (variable speed)	0 - 16,000 RPM
Overall Length	18-7/8"
Net Weight	4.3 lbs.
Shipping Weight	6.6 lbs.



**STARTS EASY,
WORKS HARD**



**FAST
EASY STARTS**



**HIGH
POWER-TO-WEIGHT
RATIO**

Makita® 2-stroke power equipment offers fast starts, reduced weight, and compact designs so you can take control of shaping the landscape and the future. You have the power. How will you rule the outdoors?

2-STROKE FEATURES

- Easy-start system delivers fast starts with less pull resistance
- Convenient touch & stop lever controls choke/run/stop
- High power-to-weight ratio
- Reduced weight and compact design offers better maneuverability
- Proven experience using technology from the world's original gas chain saws
- Steel anti-vibration mount springs engineered to reduce vibration

LEARN MORE
MAKITATOOLS.COM/OPE/2STROKE



EASY START

EA3200SR

32 cc Chain Saw

- Easy Start spring-assisted starter with optimized engine management for quick starting with less force
- Steel anti-vibration mount springs engineered to reduce vibration
- Primer pump for easy cold starting
- 13" markings on the rear handle for cutting wood to length
- Compact design with less weight (only 9.0 lbs.)
- Two point durable inertia/mechanical chain brake

	Guide Bar	Pitch	Gauge
EA3200SRBB	14"	3/8"	.050"
Engine Displacement (cu.in./cc)	1.95 cu.in. (32 cc)		
Power Rating	1.8 HP/1.3 kW		
Max. Engine Speed	12,800 RPM		
Fuel Mixture	50:1		
Fuel Tank Capacity	13.5 oz.		
Oil Tank Capacity	9.8 oz.		
Net Weight (w/o bar & chain)	9 lbs.		
User Type	Occasional user		
Chain Saw Feature	Flush cut handle		



EASY START

TOOL-LESS

EA3201SR

32 cc Chain Saw

- "Tool-less" chain tensioning for quick and convenient chain adjustment
- Easy Start spring-assisted starter with optimized engine management for quick starting with less force
- Primer pump for easy cold starting
- Compact design with less weight (only 9.4 lbs.)
- 13" markings on the rear handle for cutting wood to length
- Two point durable inertia/mechanical chain brake

	Guide Bar	Pitch	Gauge
EA3201SRBB	14"	3/8"	.050"
Engine Displacement (cu.in./cc)	1.95 cu.in. (32 cc)		
Power Rating	1.8 HP/1.3 kW		
Max. Engine Speed	12,800 RPM		
Fuel Mixture	50:1		
Fuel Tank Capacity	13.5 oz.		
Oil Tank Capacity	9.8 oz.		
Net Weight (w/o bar & chain)	9.4 lbs.		
User Type	Occasional user		
Chain Saw Feature	Flush cut handle		



EASY START

EA3500SR

35 cc Chain Saw

- Easy Start spring-assisted starter with optimized engine management for quick starting with less force
- Steel anti-vibration mount springs engineered to reduce vibration
- Primer pump for easy cold starting
- 13" markings on the rear handle for cutting wood to length
- Compact design with less weight (only 9.7 lbs.)
- Two point durable inertia/mechanical chain brake

	Guide Bar	Pitch	Gauge
EA3500SRBB	16"	3/8"	.050"
Engine Displacement (cu.in./cc)	2.14 cu.in. (35 cc)		
Power Rating	2.3 HP/1.7 kW		
Max. Engine Speed	13,100 RPM		
Fuel Mixture	50:1		
Fuel Tank Capacity	13.5 oz.		
Oil Tank Capacity	9.8 oz.		
Net Weight (w/o bar & chain)	9.7 lbs.		
User Type	Occasional user		
Chain Saw Feature	Flush cut handle		



EASY START

TOOL-LESS

EA3601FR

35 cc Chain Saw

- "Tool-less" chain tensioning for quick and convenient chain adjustment
- Stratified Air Scavenging engine for lower emissions and improved fuel efficiency
- Easy Start spring-assisted starter with optimized engine management for quick starting with less force
- Compact design with less weight (only 9.3 lbs.)

	Guide Bar	Pitch	Gauge
EA3601FRDB	16"	3/8"	.050"
Engine Displacement (cu.in./cc)	3.14 cu.in. (35.2 cc)		
Power Rating	2.3 HP/1.7 kW		
Max. Engine Speed	13,500 RPM		
Fuel Mixture	50:1		
Fuel Tank Capacity	10.5 oz.		
Oil Tank Capacity	8.8 oz.		
Net Weight (w/o bar & chain)	9.3 lbs.		
User Type	Farm/Ranch		
Chain Saw Feature	Flush cut handle		



EASY START

MAGNESIUM™

EA4300FR

42 cc Chain Saw

- High Power-to-Weight Ratio 3.0 HP engine with 2-piece magnesium housing delivers professional-grade performance in a farm saw
- "Tool-less" filter maintenance for operator efficiency
- Compact design engineered with smooth rounded surfaces for less weight (only 10.8 lbs.) and operator comfort
- Easy Start, spring assisted starter with optimized engine management reduces force required for starting
- Touch & Stop, single lever operation for immediate shut-off
- Large metal spike bar for increased control when cutting

	Guide Bar	Pitch	Gauge
EA4300FRDB	16"	3/8"	.050"
Engine Displacement (cu.in./cc)	2.6 cu.in. (42 cc)		
Power Rating	3 HP/2.2 kW		
Max. Engine Speed	13,500 RPM		
Fuel Mixture	50:1		
Fuel Tank Capacity	16.2 oz.		
Oil Tank Capacity	9.5 oz.		
Net Weight (w/o bar & chain)	10.8 lbs.		
User Type	Farm/Ranch		
Chain Saw Feature	Flush cut handle		



EASY START

MAGNESIUM™

EA5000PR

50 cc Chain Saw

- High Power-to-Weight Ratio 3.9 HP engine delivers fast acceleration and more efficient cutting performance to meet the demands of the professional
- Easy Start spring-assisted starter with optimized engine management for quick starting with less force

	Guide Bar	Pitch	Gauge
EA5000PRFL	20"	.325"	.050"
EA5000PRGG	20"	3/8"	.050"
EA5000PREL	18"	.325"	.050"
EA4300FRDB	18"	3/8"	.050"
Engine Displacement (cu.in./cc)	3.1 cu.in. (50 cc)		
Power Rating	3.9 HP/2.8 kW		
Max. Engine Speed	13,800 RPM		
Fuel Mixture	50:1		
Fuel Tank Capacity	15.9 oz.		
Oil Tank Capacity	9.1 oz.		
Net Weight (w/o bar & chain)	11.9 lbs.		
User Type	Professional		
Chain Saw Feature	Flush cut handle		



EASY START

MAGNESIUM™

EA5001PR

50 cc Chain Saw

- Heated handle for improved operator comfort in cold weather conditions
- High Power-to-Weight Ratio 3.9 HP engine delivers fast acceleration and more efficient cutting performance to meet the demands of the professional
- Easy Start spring-assisted starter for quick starting with less force
- Magnesium housing for improved durability and less weight (only 11.9 lbs.)
- Touch & Stop single lever control shuts off engine with just a touch

	Guide Bar	Pitch	Gauge
EA5001PREL	18"	.325"	.050"
EA5001PRGG	18"	3/8"	.050"
Engine Displacement (cu.in./cc)	3.1 cu.in. (50 cc)		
Power Rating	3.9 HP/2.8 kW		
Max. Engine Speed	13,800 RPM		
Fuel Mixture	50:1		
Fuel Tank Capacity	15.9 oz.		
Oil Tank Capacity	9.1 oz.		
Net Weight (w/o bar & chain)	11.9 lbs.		
User Type	Professional		
Chain Saw Feature	Heated handle		

EASY START

RIDGELINE™

From the highest highs to the lowest lows, Makita's 56cc RIDGELINE™ saws are all about versatility and providing you with the peak performance you need every day. With a high power-to-weight ratio, easier starts, and lower vibration, 56cc RIDGELINE™ saws are ideal for a range of cutting and trimming applications—especially in farm and ranch work environments. Elevate your power and rule the outdoors.



EFFICIENCY

Easy Start spring-assisted starter for quick starting with less force



DURABILITY

Heavy-duty cartridge air filter system for extended air filter life and improved durability



PERFORMANCE

Powerful 4.1 HP engine delivers high cutting performance with improved fuel efficiency



EA5600FR

56 cc RIDGELINE™ Chain Saw

- Heavy-duty cartridge air filter system for extended air filter life and improved durability
- Powerful 4.1 HP Stratified Air Scavenging engine delivers high cutting performance with improved fuel efficiency
- Easy Start spring-assisted starter with optimized engine management for quick starting with less force
- Bar nuts are retained for easy maintenance and convenience
- Compact comfortable design with less weight (12.8 lbs)
- 13,800 RPM with fast acceleration for more efficient cutting performance
- Touch & Stop single lever control shuts off engine with just a touch
- Slide-out baffle can be configured for efficient cold weather operation
- Two point durable inertia/mechanical chain brake
- Chain compartment is easy to clean and clears chips away efficiently

	Guide Bar	Pitch	Gauge
EA5600FRGG	20"	3/8"	.050"
EA5600FREG	18"	3/8"	.050"

Engine Displacement (cu.in./cc)	3.4 cu.in. (55.6 cc)
Power Rating	4.1 HP/3 kW
Max. Engine Speed	13,800 RPM
Fuel Mixture	50:1
Fuel Tank Capacity	19.3 oz.
Oil Tank Capacity	10.8 oz.
Net Weight (w/o bar & chain)	12.8 lbs.
User Type	Farm/Ranch
Chain Saw Feature	Heavy duty air filter

EA6100PR

61 cc Chain Saw

- Heavy-duty cartridge air filter system for improved durability
- Powerful 4.6 HP Stratified Air Scavenging engine delivers professional cutting performance with improved fuel efficiency
- Easy Start spring-assisted starter for quick starting with less force

	Guide Bar	Pitch	Gauge
EA6100PRGG	20"	3/8"	.050"
EA6100PREL	18"	.325"	.050"
EA6100PREG	18"	3/8"	.050"

Engine Displacement (cu.in./cc)	3.7 cu.in. (61 cc)
Power Rating	4.6 HP/3.4 kW
Max. Engine Speed	13,800 RPM
Fuel Mixture	50:1
Fuel Tank Capacity	27 oz.
Oil Tank Capacity	16 oz.
Net Weight (w/o bar & chain)	13.2 lbs.
User Type	Professional
Chain Saw Feature	Heavy duty air filter



MAGNESIUM™

EA7300PR

73 cc Chain Saw

- High Power-to-Weight Ratio 5.4 HP engine delivers fast acceleration and more efficient cutting performance to meet the demands of the professional
- Magnesium housing for improved durability and less weight (only 14.7 lbs.)
- Chain compartment is easy to clean and clears chips away efficiently when other saws become clogged
- Decompression valve reduces force required for starting
- Easy-starting automatic half throttle lock
- Slide out baffle can be configured for efficient cold weather operation

	Power Head Only	Heavy Duty Filter	Handle Type
EA7300PRZ	●		Flush Cut

Engine Displacement (cu.in./cc)	4.4 cu.in. (72.6 cc)
Power Rating	5.4 HP/4.1 kW
Max. Engine Speed	12,800 RPM
Fuel Mixture	50:1
Fuel Tank Capacity	25.4 oz.
Oil Tank Capacity	14.2 oz.
Net Weight (w/o bar & chain)	14.7 lbs.
User Type	Professional
Chain Saw Configuration	Powerhead only
Chain Saw Feature	Flush cut handle



MAGNESIUM™

EA7301PR

73 cc Chain Saw

- Heated handle for improved operator comfort in cold weather conditions
- High Power-to-Weight Ratio 5.4 HP engine delivers fast acceleration and more efficient cutting performance to meet the demands of the professional
- Slide out baffle can be configured for improved performance in cold weather conditions
- Chain compartment is easy to clean and clears chips away efficiently
- Decompression valve reduces force required for starting
- Easy-starting automatic half throttle lock

	Power Head Only	Heavy Duty Filter	Handle Type
EA7301PRZ	●		Heated

Engine Displacement (cu.in./cc)	4.4 cu.in. (72.6 cc)
Power Rating	5.4 HP/4.1 kW
Max. Engine Speed	12,800 RPM
Fuel Mixture	50:1
Fuel Tank Capacity	25.4 oz.
Oil Tank Capacity	14.2 oz.
Net Weight (w/o bar & chain)	14.7 lbs.
User Type	Professional
Chain Saw Configuration	Powerhead only
Chain Saw Feature	Heated handle



MAGNESIUM™

EA7900PR

79 cc Chain Saw

- High Power-to-Weight Ratio 5.7 HP engine delivers fast acceleration and more efficient cutting performance to meet the demands of the professional
- Decompression valve reduces force required for starting
- Chain compartment is easy to clean and clears chips away efficiently when other saws become clogged

	Power Head Only	Heavy Duty Filter	Handle Type
EA7900PRZ2	●	●	Full Wrap
EA7900PRZ1	●	●	Flush Cut
EA7900PRZ	●		Flush Cut

Engine Displacement (cu.in./cc)	4.8 cu.in. (78.5 cc)
Power Rating	5.7 HP/4.3 kW
Max. Engine Speed	12,800 RPM
Fuel Mixture	50:1
Fuel Tank Capacity	25.4 oz.
Oil Tank Capacity	14.2 oz.
Net Weight (w/o bar & chain)	14.7 lbs.
User Type	Professional
Chain Saw Configuration	Powerhead only
Chain Saw Feature	Flush cut handle



MAGNESIUM™

EA7901PR







79 cc Chain Saw





- Heated handle for improved operator comfort in cold weather conditions
- High Power-to-Weight Ratio 5.7 HP engine delivers fast acceleration and more efficient cutting performance to meet the demands of the professional
- Slide out baffle can be configured for efficient cold weather operation
- Chain compartment is easy to clean and clears chips away efficiently

	Power Head Only	Heavy Duty Filter	Handle Type
EA7901PRZ1	●	●	Heated
EA7901PRZ	●		Heated





Engine Displacement (cu.in./cc)	4.8 cu.in. (78.5 cc)
Power Rating	5.7 HP/4.3 kW
Max. Engine Speed	12,800 RPM
Fuel Mixture	50:1
Fuel Tank Capacity	25.4 oz.
Oil Tank Capacity	14.2 oz.
Net Weight (w/o bar & chain)	14.7 lbs.
User Type	Professional
Chain Saw Configuration	Powerhead only
Chain Saw Feature	Heated handle

COUPLE SHAFT ATTACHMENTS (COMPATIBLE W/ EX2650LH, XUX01Z, XUX01M5)















Part #	Fits Models
 EM400MP Brush Cutter Couple Shaft Attachment Arbor M10 x 1.25LH	XUX01ZM5, XUX01Z, EX2650LH
 EM405MP String Trimmer Couple Shaft Attachment Arbor M10 x 1.25LH	
 ER400MP Curved String Trimmer Couple Shaft Attachment Arbor M8 x 1.25LH	
 EY401MP Pole Saw Couple Shaft Attachment 10" Bar Length	
 EN401MP Articulating Hedge Trimmer Couple Shaft Attachment 180° Blade Adjustment 20" Bar Length	
 EN410MP Hedge Trimmer Couple Shaft Attachment 24" Bar Length	

Part #	Fits Models
 KR401MP Cultivator Couple Shaft Attachment 8" Tine Diameter	XUX01ZM5, XUX01Z, EX2650LH
 EE400MP Edger Couple Shaft Attachment* 8" Blade Diameter *for use with EX2650LH Only	EX2650LH
 LE400MP Shaft Extension Couple Shaft Attachment 42" Length	XUX01ZM5, XUX01Z, EX2650LH
 SW400MP Paddle Sweep Couple Shaft Attachment 23-1/4" Sweeping Surface	
 BR400MP Bristle Brush Couple Shaft Attachment 23-5/8" Sweeping Surface	

TRIMMER ATTACHMENTS

Part #	Includes	Fits Models
 135683-8 Articulating Hedge Trimmer Attachment 20" Blade Length	Blade Cover	EM2650LH, EM2650UH, EM2652LHN, EE2650H, EN4950H, EN4951SH, EN5550SH, EN5950SH, EN7350SH
 A-89523 Articulating Hedge Trimmer Attachment 22" Blade Length		
 135544-2 Double-Sided Hedge Trimmer Attachment 24" Blade Length		
 135545-0 Single-Sided Hedge Trimmer Attachment 29" Blade Length		
 196315-2 Pole Saw Attachment 10" Bar		

TRIMMER LINE ACCESSORIES

Part #	Gauge & Style	Weight	Quantity
 T-03361	.080" Round	1 lb.	1/Pk
 T-03707	.080" Round	1 lb.	12/pk
 T-03377	.080" Round	3 lbs.	1/Pk
 T-03713	.080" Round	3 lbs.	4/pk
 T-03408	.095" Round	1 lbs.	1/Pk
 T-03729	.095" Round	1 lbs.	12/pk
 T-03414	.095" Round	3 lbs.	1/pk
 T-03735	.095" Round	3 lbs.	4/pk
 T-03420	.095" Round	5 lbs.	1/pk
 T-03741	.095" Round	5 lbs.	6/pk
 T-03442	.105" Round	1 lbs.	1/pk
 T-03757	.105" Round	1 lbs.	12/pk
 T-03458	.105" Round	3 lbs.	1/pk
 T-03763	.105" Round	3 lbs.	4/pk
 T-03464	.105" Round	5 lbs.	1/pk
T-03779	.105" Round	5 lbs.	6/pk

TRIMMER ACCESSORIES

Part #	Includes	Fits Models
 B-14118 9" Star Blade, 4 Tooth	9" Star Blade, 1" Arbor	EM2650LH*, EM2652LHN*, EM2650UH

*Requires Brush Cutter Conversion Kit (196500-7)



















Part #	Includes	Fits Models
122906-3 Brush Cutter Harness	Harness	EM2650LH, EM2652LHN, EM2650UH, EX2650LH, XUX01Z, XRU09Z, XRU11Z



Part #	Includes	Fits Models
197680-2 Trimmer Service Kit	Spark Plug, Fuel Filter, Air Filters	EM2650LH, EM2650UH, EM2652LHN, EE2650H, EN4950H, EN4951SH, EN5550SH, EN5950SH, EN7350SH

TRIMMER HEADS

Series	Part #	Arbor Size	Gauge & Style	Line Capacity	FITS TRIMMER MODELS													
					EM2650LH	EM2652LHN	EM2650UH	XRU09	XRU11	XRU08	XRU13	XRU04	EM400MP	EM405MP	ER400MP	XUX01ZMS	RU03	
RAPID LOAD SERIES	 T-01753A 10mm LH Comfort Trim Bump & Feed Head	M10 x 1.25 LH	.095" Premium Round	20 ft. of .080" 18 ft. of .095" 16 ft. of .105" 13 ft. of .110"	●	●	●	●						●	●		●	
	 T-02917 8mm LH Comfort Trim Bump & Feed Head	M8 x 1.25 LH	.095" Premium Round	20 ft. of .080" 18 ft. of .095" 16 ft. of .105" 13 ft. of .110"					●				●					
	 T-03187 8mm RH Comfort Trim Bump & Feed Head	M8 x 1.25 RH	.095" Premium Round	20 ft. of .080" 18 ft. of .095" 16 ft. of .105" 13 ft. of .110"						●	●						●	
HIGH CAPACITY SERIES	 B-05119** High Capacity Bump & Feed Head	M10 x 1.25 LH	.095" Standard Round	30 ft. of .080" 20 ft. of .095" 20 ft. of .105" 10 ft. of .130"	●	●	●						●	●				
	 713301-C** Bump & Feed Trimmer Head	M10 x 1.25 LH	.095" Standard Round	30 ft. of .080" 20 ft. of .095" 20 ft. of .105" 10 ft. of .130"	●	●	●						●	●				
	 713300-C** Manual Feed Trimmer Head	M10 x 1.25 LH	.095" Standard Round	30 ft. of .080" 20 ft. of .095" 20 ft. of .105" 10 ft. of .130"	●	●	●						●	●				
FIXED LINE	 B-02951* Fixed Line Trimmer Head	Universal	.095" Standard Round	5 ft. of .105" 5 ft. of .110" 4 ft. of .130"	●	●	●	●					●	●			●	
BUMP & AUTOFEED SERIES	 B-60109 Bump & Auto Feed Trimmer Head	LH Universal	.095" Standard Round	17 ft. of .080" 12 ft. of .095" 10 ft. of .105" 9 ft. of .110"	●	●	●	●	●				●	●	●		●	
	 B-60121 Bump & Auto Feed Trimmer Head	RH Universal	.095" Standard Round	20 ft. of .080" 16 ft. of .095" 14 ft. of .105" 13 ft. of .110"						●	●					●		
BUMP & FEED SERIES	 197297-1 Bump & Feed Trimmer Head	M8 x 1.25 RH	.080" Standard Twisted Round	20 ft. of .080" 18 ft. of .095" 16 ft. of .105" 13 ft. of .110"						●	●					●		
	 198972-2 Bump & Feed Trimmer Head	M8 x 1.25 RH	.080" Standard Twisted Round	20 ft. of .080" 18 ft. of .095" 16 ft. of .105" 13 ft. of .110"						●	●					●		
	 198386-5 Bump & Feed Trimmer Head	M8 x 1.25 LH	.080" Standard Twisted Round	20 ft. of .080" 18 ft. of .095" 16 ft. of .105" 13 ft. of .110"					●				●					
	 197296-3 Bump & Feed Trimmer Head	M10 x 1.25 LH	.080" Standard Twisted Round	20 ft. of .080" 18 ft. of .095" 16 ft. of .105" 13 ft. of .110"	●	●	●	●					●	●			●	
	 198892-0 Bump & Feed Trimmer Head	M10 x 1.25 LH	.080" Standard Twisted Round	20 ft. of .080" 18 ft. of .095" 16 ft. of .105" 13 ft. of .110"	●	●	●	●					●	●			●	
	 122980-1 Bump & Feed Trimmer Head	M8 x 1.25 RH	.095" Standard Round	20 ft. of .080" 18 ft. of .095" 16 ft. of .105" 13 ft. of .110"						●	●					●		
COMPACT SERIES	 198847-5 Single Cutter Trimmer Head	M8 x 1.25 RH	Serrated Single Cutter	-													●	
	 198853-0 Bump & Feed Trimmer Head	M8 x 1.25 RH	.065" Standard Round	26 ft. of .065"													●	

*B-02951 Fixed Line Trimmer Head requires Hex Lock Nut M10-17 (264088-6)
**Recommended for use with gas power head on EM400MP and EM405MP

BRUSH CUTTER CONVERSION KIT



Part #	Includes	Fits Models
196500-7 Conveniently converts Makita® string trimmer into a blade capable grass trimmer	Harness, Protector, Barrier Bar, Clamp, Cup, Nut M10-17, Universal Wrench	EM2650LH, EM2652LHN

CHAIN SAW GUIDE BARS



Part #	Length	Pitch	Gauge	Mount #	Bar Style	XCU01	XCU02	XCU03	XCU04	XCU06	UC3551A	UC4051A	EA3200SR	EA3201SR	EA3500SR	EA3601FR	EA4300FR	EA5000PR	EA5001PR	EA5600FR	EA6100PR	DCS642TR	EA7300PR	EA7301PR	EA7900PR	EA7901PR	EY2650H25H
158476-6 w/ Tip Guard	4-1/2"	1/4"	.050"	-	Tip Guard	●																					
161846-0 Low Profile	10"	3/8"	.043"	A041	SNL		●	●	●	●																	
165695-7 Low Profile	10"	3/8"	.050"	A218	SNL																						●
165245-8 Narrow Kerf	12"	3/8"	.043"	A041	SNL		●	●	●	●	●	●	●	●	●	●	●										
163150-3 w/ Tip Guard	12"	3/8"	.050"	A041	SNL		●	●	●	●	●	●	●	●	●	●	●										
165246-6 Narrow Kerf	14"	3/8"	.043"	A041	SNL			●	●	●	●	●	●	●	●	●	●										
165201-8 Low Profile	14"	3/8"	.050"	A041	SNL			●	●	●	●	●	●	●	●	●	●										
165247-4 Narrow Kerf	16"	3/8"	.043"	A041	SNL			●	●	●	●	●	●	●	●	●	●										
442-040-661 Low Profile	16"	3/8"	.050"	A041	SNL			●	●	●	●	●	●	●	●	●	●										
445-045-641 Mid-Range	18"	.325"	.050"	K095	SNL													●	●	●	●						
443-045-661 Mid-Range	18"	3/8"	.050"	K095	SNL													●	●	●	●						
445-050-641 Standard	20"	.325"	.050"	K095	SNL													●	●	●	●						
445-050-665 Standard	20"	3/8"	.050"	D009	SNL																	●	●	●	●	●	
443-053-661 Standard	20"	3/8"	.050"	K095	SNL													●	●	●	●						
713200-A Replaceable Tip	20"	3/8"	.050"	K095	SNR													●	●	●	●						
713204-A Replaceable Tip	20"	3/8"	.050"	D009	SNR																	●	●	●	●	●	
713205-A Replaceable Bar Nose	24"	3/8"	.050"	D009	SNR																	●	●	●	●	●	
713206-A Replaceable Tip	28"	3/8"	.050"	D009	SNR																	●	●	●	●	●	
713207-A Replaceable Tip	32"	3/8"	.050"	D009	SNR																	●	●	●	●	●	

SAFETY EQUIPMENT

Combo Safety Helmet 986-200-002



- Adjustable design easily adjusts to operator for improved comfort
- Face protector allows good view of the working area
- Ear protectors are easily adjustable
- Ideal for use with Makita Chain Saws

Chain Saw Case B-70777



- Low-profile, rounded carrying handle for user comfort
- Engineered for efficient transport of chain saw to and from the job site
- Durable plastic molding for increased protection
- Less weight for user comfort

Chain Saw Chaps

- Durable design with less weight for improved operator comfort
- Easy to put on and adjust to fit operator
- Intended, under limited conditions; in reducing the severity of injury from a gasoline running chain saw that contacts the operator's leg

Part #	Size
986-200-006	32"
986-200-007	36"
841008-A	38"
986-200-008	40"



CHAIN SAW CHAINS



Part #	Length	Pitch	Gauge	Drive Links	Chain Type	File Size	FITS GUIDE BARS																				
							158476-6	161846-0	165695-7	165245-8	163150-3	165246-6	165201-8	165247-4	442-040-661	445-045-641	443-045-661	445-050-641	445-050-665	443-053-661	713200-A	713204-A	713205-A	713206-A	713207-A		
791284-8	4-1/2"	1/4"	.050"	42	25AP	5/32"	●																				
199075-5	10"	3/8"	.043"	40	90PX	4.5mm		●																			
196142-7	10"	3/8"	.050"	39	91VXL	5/32"			●																		
531-291-646	12"	3/8"	.043"	46	90PX	4.5 mm				●																	
196519-6	12"	3/8"	.050"	45	91PX	5/32"					●																
196741-5	14"	3/8"	.043"	52	90PX	4.5 mm						●															
196207-5	14"	3/8"	.050"	52	91PX	5/32"							●														
196742-3	16"	3/8"	.043"	56	90PX	4.5mm								●													
196208-3	16"	3/8"	.050"	56	91PX	5/32"									●												
513-486-672	18"	.325"	.050"	72	20BP	3/16"										●											
523-102-064	18"	3/8"	.050"	64	72V	7/32"											●										
513-486-078	20"	.325"	.050"	78	20BP	3/16"												●									
523-100-072	20"	3/8"	.050"	72	72LG	7/32"													●	●	●	●					
523-102-072A	20"	3/8"	.050"	72	72V	7/32"														●	●	●	●				
713105-A	24"	3/8"	.050"	84	72LG	7/32"																			●		
713106-A	28"	3/8"	.050"	92	72LG	7/32"																				●	
713107-A	32"	3/8"	.050"	105	72LG	7/32"																					●

*Per ANSI B175.1 2012

ACCESSORIES

Chain Protectors



Part #	Size	Fits Models
416311-7	5"	XCU01Z
452093-7	10"	EY2650H25H, XCU06
419242-9	14-16"	XCU03, EA3200S, EA3201S, EA3500S, EA3601F, EA4300F
419560-5	18"	DCS5121, EA5000P, EA6100P
952-020-650	20"	DCS5121, EA5000P, EA6100P, DCS6421
952-020-660	24"	EA7300P, EA7301P, EA7900P, EA7900P
952-030-180	32"	EA7300P, EA7301P, EA7900P, EA7900P

Bar & Chain Oil



Part #	Fits Models
181119-A (Summer Mix) 1 Quart Bar and Chain Oil	All Makita® Chain Saws
181119-A-12 (Summer Mix 12/Pk) 1 Quart Bar and Chain Oil	
181116-A (Summer Mix) 1 Gallon Bar and Chain Oil	
181116-A-4 (Summer Mix 4/Pk) 1 Gallon Bar and Chain Oil	
T-03159-4 (Winter Mix 4/Pk) 1 Gallon Bar and Chain Oil	



Part #	Includes	Fits Models
Vacuum Kit 195282-8 Engineered for efficient collection of leaves and debris	Dust Bag, Elbow, Pipes	BHX2500CA
Shoulder Strap 166094-6 Distributes weight evenly for improved operator comfort during extended use	Shoulder Strap	XBU02

Blower Nozzles



Part #	Fits Models
451753-8 Flat End Nozzle	BHX2500CA
455631-4 Short End Nozzle	BBX7600CA, BBX7600N
454896-5 End Nozzle 90-60	EB7650TH, EB7650WH, EB7660TH, EB7660WH
454916-5 Flat End Nozzle 90	EB7650TH, EB7650WH, EB7660TH, EB7660WH
455128-3 End Nozzle 90-70	EB7650TH, EB7650WH, EB7660TH, EB7660WH
197888-8 Extension Nozzle	XBU02
198034-6 End Nozzle	EB5300TH, EB5300WH
197889-6 Flat Nozzle	XBU02

GAS EQUIPMENT

Filter Kits



315-173-010



957-173-400



195599-9

Part #	Includes	Fits Models
957-173-400 Heavy Duty Filter Kit	Paper Filter, Felt Pre-Filter, Base, Clamp, Connecting Sleeve, Bottom, Filter Hood	DCS6421, EA7300P, EA7301P, EA7900P, EA7901P
957-173-110 5+1 Filter Set	5 Pre-Filters, 1 Paper Filter	EK7301, EK8100
195599-9 5+1 Filter Set	5 Pre-Filters, 1 Paper Filter	EK7651H

Lubricants



Part #	Includes	Fits Models
195826-4 10W-30 Engine Oil	80ml of Oil	24.5 and 25.4 cc MM4® Engines
195826-4-48 10W-30 Engine Oil (48)	80ml of Oil	
T-02484 10W-30 Engine Oil	200ml of Oil	75.6cc MM4® Engines
T-02490 10W-30 Engine Oil (12)	200ml of Oil	
T-00745 Synthetic 1 Gallon Mix, 50:1 2-Stroke Fuel Mix	2.6 oz. 2-Stroke Mix Oil	All 2-Stroke Models
T-00745-48 Synthetic 1 Gallon Mix, 50:1 2-Stroke Fuel Mix (48)	48 Bottles of 2.6 oz. 2-Stroke Mix Oil	
T-00739 Synthetic 2.5 Gallon Mix, 50:1 2-Stroke Fuel Mix	6.4 oz. 2-Stroke Mix Oil	
T-00739-48 Synthetic 2.5 Gallon Mix, 50:1 2-Stroke Fuel Mix (48)	48 Bottles of 6.4 oz. 2-Stroke Mix Oil	



PRECISION MACHINED TIP
Reduces Cam Out

PERFORMANCE OPTIMIZED STEEL
Extends Life

CALIBRATED HEAT TREAT
Maximizes Durability

FULL CONTACT IMPACT DRIVING

Introducing ImpactX™ Makita's comprehensive new line of over 80 impact-rated insert bits and fastening accessories, designed specifically for the demands of professional users. Engineered from the ground up to work with today's wide range of industrial fasteners and the force of high-torque impact drivers, ImpactX™ delivers superior fitment, reduced cam-out, added durability and outstanding performance for any job application.

IMPACTX™ BIT SETS

Description Part #

ImpactX™ 35-Pc. Bit Set A-98326



35 Pc.
IMPACT RATED

UNIVERSAL DRIVE FITS ALL BRANDS

Includes:

(28) 1" Insert Bits

- 1 ea. #1 Phillips, 7 ea. #2 Phillips
- 2 ea. #3 Phillips, 1 ea. #1 Square
- 4 ea. #2 Square, 2 ea. #3 Square
- 1 ea. #10 Torx®, 2 ea. #15 Torx®
- 2 ea. #20 Torx®, 2 ea. #25 Torx®
- 1 ea. #27 Torx®, 1 ea. #30 Torx®
- 1 ea. #8 Slotted, 1 ea. #10 Slotted

(4) 2" Power Bits

- 2 ea. #2 Phillips, 1 ea. #2 Square,
- 1 ea. #25 Torx®

(1) Insert Bit Holders

- 1 ea. 2-3/8"

(2) 1-3/4" Nut Drivers

- 1 ea. 1/4", 1 ea. 5/16"

Description Part #

ImpactX™ 40-Pc. Bit Set A-98332



40 Pc.
IMPACT RATED

UNIVERSAL DRIVE FITS ALL BRANDS

Includes:

(29) 1" Insert Bits

- 1 ea. #1 Phillips, 8 ea. #2 Phillips,
- 2 ea. #3 Phillips, 1 ea. #1 Square,
- 4 ea. #2 Square, 2 ea. #3 Square,
- 1 ea. #10 Torx®, 2 ea. #15 Torx®,
- 2 ea. #20 Torx®, 2 ea. #25 Torx®,
- 1 ea. #27 Torx®, 1 ea. #30 Torx®,
- 1 ea. #8 Slotted, 1 ea. #10 Slotted

(5) 2" Power Bits

- 3 ea. #2 Phillips, 1 ea. #2 Square,
- 1 ea. #25 Torx®

(2) 3-1/2" Power Bits

- 1 ea. #2 Phillips, 1 ea. #2 Square

(1) Insert Bit Holders

- 1 ea. 2-3/8"

(3) 1-3/4" Nut Drivers

- 1 ea. 1/4", 1 ea. 5/16", 1 ea. 3/8"

Description Part #

ImpactX™ 50-Pc. Bit Set A-98348



50 Pc.
IMPACT RATED

UNIVERSAL DRIVE FITS ALL BRANDS

Includes:

(32) 1" Insert Bits

- 2 ea. #1 Phillips, 9 ea. #2 Phillips,
- 2 ea. #3 Phillips, 2 ea. #1 Square,
- 4 ea. #2 Square, 2 ea. #3 Square,
- 1 ea. #10 Torx®, 2 ea. #15 Torx®,
- 2 ea. #20 Torx®, 2 ea. #25 Torx®,
- 1 ea. #27 Torx®, 1 ea. #30 Torx®,
- 1 ea. #8 Slotted, 1 ea. #10 Slotted

(2) 3-1/2" Power Bits

- 1 ea. #2 Phillips, 1 ea. #2 Square

(10) 2" Power Bits

- 3 ea. #2 Phillips, 1 ea. #3 Phillips,
- 1 ea. #2 Square, 1 ea. #3 Square,
- 1 ea. #15 Torx®, 1 ea. #20 Torx®,
- 1 ea. #25 Torx®, 1 ea. #10 Slotted

(2) Insert Bit Holders

- 1 ea. 2-3/8", 1 ea. 6"

(1) 2" Socket Adapter

- 1 ea. 3/8"

(3) 1-3/4" Nut Drivers

- 1 ea. 1/4", 1 ea. 5/16", 1 ea. 3/8"

IMPACTX™ INSERT BITS

Type	Description	Length	Qty./Pkg.	Part #
Phillips Insert Bit	#1	1"	2	A-96453
	#1	1"	50	A-98821
	#2	1"	2	A-96469
	#2	1"	25	A-99758
	#2	1"	50	A-96475
	#2	1"	200	A-97324
	#2	1"	250	A-97302-10
	#2 Reduced	1"	2	A-98837
	#2 Reduced	1"	25	A-99764
	#2 Reduced	1"	50	A-98859
	#2 Reduced	1"	200	A-98865
	#2 Reduced	1"	250	A-98843-10
	#3	1"	2	A-96481
#3	1"	50	A-96497	

Type	Description	Length	Qty./Pkg.	Part #
Slotted Insert Bit	#8	1"	2	A-96621
	#10	1"	2	A-96637

Type	Description	Length	Qty./Pkg.	Part #
Square Insert Bit	#1	1"	2	A-96506
	#1	1"	50	A-98887
	#2	1"	2	A-96512
	#2	1"	25	A-99770
	#2	1"	50	A-96528
	#2	1"	200	A-97346
	#2	1"	250	A-97330-10
	#3	1"	2	A-96534
#3	1"	50	A-98893	

Type	Description	Part #
Torx® Insert Bit	7 Pc. 1" Torx® Insert Bit Set Includes: 1 ea. #10, #15, #20, #25, #27, #30, #40	A-96615

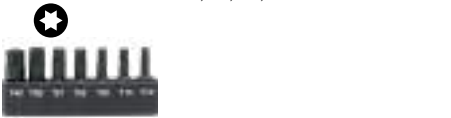

Type	Description	Length	Qty./Pkg.	Part #
Torx® Insert Bit	#10	1"	2	A-96540
	#10	1"	50	A-98902
	#15	1"	2	A-96556
	#15	1"	50	A-98918
	#20	1"	2	A-96562
	#20	1"	50	A-98924
	#25	1"	2	A-96578
	#25	1"	25	A-97352
	#25	1"	50	A-98930
	#27	1"	2	A-96584
	#27	1"	50	A-98946
	#30	1"	2	A-96590
	#30	1"	50	A-98952
	#40	1"	2	A-96609
#40	1"	50	A-98968	

- Precision machined tips with superior fitment for full contact fit and longer life
- Performance-optimized S2 steel construction for extended life
- Calibrated heat treating process for added durability
- Manganese Phosphate surface for advanced corrosion resistance
- Optimal geometry for an ideal fit and improved holding power

IMPACTX™ BIT HOLDERS

Type	Length	Qty./Pkg.	Part #
Two-Piece Magnetic Bit Holder	2-3/8"	1	A-96920
	2-3/8"	10	A-96936
	3"	1	A-96942
	3"	10	A-99281
	6"	1	A-96958
	6"	10	A-99297
	12"	1	A-96964
	12"	10	A-99306

- Magnetic bit holder provides convenient pick-up and retention of screws
- C-clip securely retains 1" bits in the holder
- Two-piece design is engineered for maximum versatility



Type	Length	Qty./Pkg.	Part #
One-Piece Magnetic Bit Holder	2-3/8"	1	A-96970
	2-3/8"	10	A-96986
	3"	1	A-96992
	3"	10	A-99312
	6"	1	A-97003
	6"	10	A-99328
	12"	1	A-97019
	12"	10	A-99334



- Magnetic bit holder provides convenient pick-up and retention of screws
- C-clip securely retains 1" bits in the holder
- One-piece design is engineered for maximum versatility



Type	Length	Qty./Pkg.	Part #
Finder/Driver™	3"	1	A-97075
	3"	10	A-99340
	3"	25	A-97380
	4-3/4"	1	A-97081
	4-3/4"	10	A-99356
	4-3/4"	25	A-97396

- Convenient retracting sleeve for easy one-handed operation
- Holds and drives screws without wobble or disengaging from the bit
- High-quality steel engineered for use with impact drivers



IMPACTX™ POWER BITS

Type	Description	Length	Qty./Pkg.	Part #
Phillips Power Bit  	#1	2"	2	A-96643
	#1	2"	50	A-98974
	#2	2"	2	A-96659
	#2	2"	5	A-96665
	#2	2"	15	A-99786
	#2	2"	50	A-98980
	#2	2"	100	A-97368
	#2	2"	150	A-96671-10
	#3	2"	2	A-96687
	#3	2"	50	A-98996
	#1	3-1/2"	1	A-96811
	#1	3-1/2"	50	A-99100
	#2	3-1/2"	1	A-96827
	#2	3-1/2"	50	A-99116
	#3	3-1/2"	1	A-96833
	#3	3-1/2"	50	A-99122
	#1	6"	1	A-96877
	#1	6"	25	A-99166
	#2	6"	1	A-96883
	#2	6"	25	A-99172
	#3	6"	1	A-96899
	#3	6"	25	A-99188
	#1	12"	10	A-99225
	#2	12"	1	A-96914
	#2	12"	10	A-99231
	#3	12"	10	A-99247

Type	Description	Length	Qty./Pkg.	Part #
Square Power Bit  	#1	2"	2	A-96693
	#1	2"	50	A-99007
	#2	2"	2	A-96702
	#2	2"	15	A-99792
	#2	2"	50	A-99013
	#2	2"	100	A-97374
	#2	2"	150	A-97405-10
	#3	2"	2	A-96718
	#3	2"	50	A-99029
	#1	3-1/2"	1	A-96849
	#1	3-1/2"	50	A-99138
	#2	3-1/2"	1	A-96855
	#2	3-1/2"	50	A-99144
	#3	3-1/2"	1	A-96861
	#3	3-1/2"	50	A-99150
	#1	6"	25	A-99194
	#2	6"	1	A-96908
	#2	6"	25	A-99203
	#3	6"	25	A-99219
	#1	12"	10	A-99253
	#2	12"	10	A-99269
	#3	12"	10	A-99275

Type	Description	Length	Qty./Pkg.	Part #
Slotted Power Bit  	#8	2"	2	A-96796
	#10	2"	2	A-96805



- Precision machined tips with superior fitment for full contact fit and longer life
- Performance-optimized S2 steel construction for extended life
- Calibrated heat treating process for added durability
- Manganese Phosphate surface for advanced corrosion resistance
- Optimal geometry for an ideal fit and improved holding power

Type	Description	Length	Qty./Pkg.	Part #
Torx® Power Bit  	#10	2"	2	A-96724
	#10	2"	50	A-99035
	#15	2"	2	A-96730
	#15	2"	50	A-99041
	#20	2"	2	A-96746
	#20	2"	50	A-99057
	#25	2"	2	A-96752
	#25	2"	50	A-99063
	#27	2"	2	A-96768
	#27	2"	50	A-99079
	#30	2"	2	A-96774
	#30	2"	50	A-99085
	#40	2"	2	A-96780
	#40	2"	50	A-99091

IMPACTX™ SOCKET ADAPTERS

Type	Description	Length	Qty./Pkg.	Part #	
Socket Adapters 		2"	1	A-97025	
		2"	10	A-99362	
	1/4" Drive		6"	1	A-97031
			6"	10	A-99378
			12"	1	A-97047
			12"	10	A-99384
	3/8" Drive		2"	1	A-97053
			2"	10	A-99390
			6"	10	A-99409
			12"	10	A-99415
	1/2" Drive		2"	1	A-97069
			2"	10	A-99421
			6"	10	A-99437
	12"	10	A-99443		
	3-Pc. Socket Adapter Set Includes: 1 ea. 1/4", 3/8", 1/2"	2"	3	A-97673	

IMPACTX™ MAGNETIC NUT DRIVER SETS

Type	Description	Length	Qty./Pkg.	Part #
	3-Pc. Magnetic Nut Driver Includes: 1 ea. 1/4", 5/16, 3/8"	1-3/4"	3	A-97265
	4-Pc. Magnetic Nut Driver Includes: 1 ea. 1/4", 5/16, 3/8", 7/16"	1-3/4"	4	A-97639
	3-Pc. Magnetic Nut Driver Includes: 1 ea. 1/4", 5/16, 3/8"	2-9/16"	3	A-97689
	3-Pc. Magnetic Nut Driver Includes: 1 ea. 1/4", 5/16, 3/8"	6"	3	A-97695

IMPACTX™ MAGNETIC NUT DRIVERS

Type	Description	Length	Qty./Pkg.	Part #	
Magnetic Nut Drivers 		1-3/4"	1	A-97097	
		1-3/4"	3	A-97645	
	1/4" Magnetic Nut Driver		1-3/4"	10	A-97106
			2-9/16"	1	A-97112
			2-9/16"	10	A-97128
			6"	1	A-97134
	5/16" Magnetic Nut Driver		6"	10	A-99459
			1-3/4"	1	A-97140
			1-3/4"	3	A-97651
			1-3/4"	10	A-97156
			2-9/16"	1	A-97162
			2-9/16"	10	A-97178
3/8" Magnetic Nut Driver		6"	1	A-97184	
		6"	10	A-99465	
		1-3/4"	1	A-97190	
		1-3/4"	3	A-97667	
		1-3/4"	10	A-97209	
		2-9/16"	1	A-97215	
7/16" Magnetic Nut Driver		2-9/16"	10	A-97221	
		6"	1	A-97237	
		6"	10	A-99471	
		1-3/4"	1	A-97243	
		1-3/4"	10	A-99487	
		2-9/16"	1	A-97259	
	2-9/16"	10	A-99493		
	6"	10	A-99502		

LEARN MORE
MAKITATOOLS.COM/IMPACTX

THE GOLD STANDARD IN IMPACT DRIVING

Standard insert bits are lagging behind the increased fastening power of high torque impact drivers, and the result is more broken bits and more wasted time for contractors. Impact GOLD® is the new Gold Standard in impact driving, with high quality steel for extra strength and Xtreme Torsion Technology which allows the torsion section of the bit to flex under load and take pressure off of the tip for longer bit life. Impact GOLD® is exclusively designed for use with high-torque impact drivers, and is engineered to last up to 60x longer than standard insert bits and fastening accessories. Impact GOLD® offers an expanding line of insert bits and bit holders as well as double-ended power bits, nutsetters, impact sockets and socket adapters.

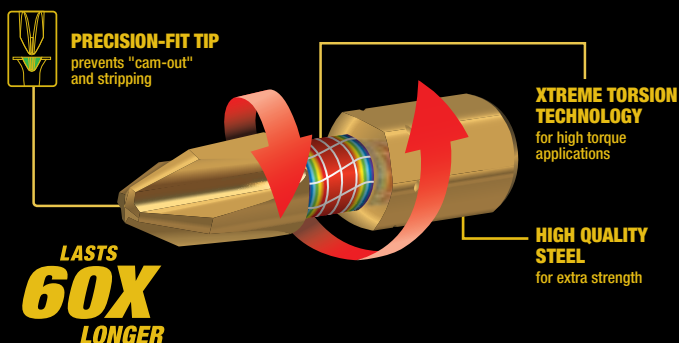

IMPACT GOLD® BIT SETS

Description	Part #
38-Pc. Torsion Bit Set Includes: • (2) #2 Phillips / #2 Square 2-1/2" Double-Ended Power Bit • (2) #2 Phillips / #25 Torx® 2-1/2" Double-Ended Power Bit • (1) #2 Phillips / #30 Torx® 2-1/2" Double-Ended Power Bit • (1) 1/4" Detachable Nutsetter • (1) 5/16" Detachable Nutsetter • (1) 3/8" Detachable Nutsetter • (1) Detachable Nutsetter Adapter • (1) 1/4" Socket Adapter • (1) Mag Boost • (1) Torsion Bit Holder • (2) #1 1" Phillips Insert Bit • (8) #2 1" Phillips Insert Bit • (2) #3 1" Phillips Insert Bit • (1) #1 1" Square Insert Bit • (3) #2 1" Square Insert Bit • (1) #3 1" Square Insert Bit • (1) #10 1" Torx® Insert Bit • (1) #15 1" Torx® Insert Bit • (2) #20 1" Torx® Insert Bit • (3) #25 1" Torx® Insert Bit • (2) #30 1" Torx® Insert Bit	B-52370

Description	Part #
26-Pc. Torsion Bit Set Includes: • (1) #2 2-1/2" Phillips Double-Ended Power Bit • (1) #3 2-1/2" Phillips Double-Ended Power Bit • (1) Mag Boost • (1) 1/4" Magnetic Nutsetter • (1) 5/16" Magnetic Nutsetter • (1) Torsion Bit Holder • (2) #1 1" Phillips Insert Bit • (5) #2 1" Phillips Insert Bit • (3) #3 1" Phillips Insert Bit • (1) #1 Square Insert Bit • (2) #2 Square Insert Bit • (1) #3 Square Insert Bit • (1) #15 1" Torx® Insert Bit • (1) #20 1" Torx® Insert Bit • (2) #25 1" Torx® Insert Bit • (1) #27 1" Torx® Insert Bit • (1) #30 1" Torx® Insert Bit	B-46919

Description	Part #
21-Pc. Ultra-Magnetic Insert Bit Set Includes: • (1) Ultra Magnetic Insert Bit Holder • (1) #1 1" Phillips Insert Bit • (13) #2 1" Phillips Insert Bit • (1) #3 1" Phillips Insert Bit • (1) #2 1" Square Insert Bit • (1) #3 1" Square Insert Bit • (1) #15 1" Torx® Insert Bit • (1) #20 1" Torx® Insert Bit • (1) #25 1" Torx® Insert Bit	B-31893

Description	Part #
14 Pc. Titanium Drill Bit Set Includes: • (1) 1/16" • (1) 5/64" • (1) 3/32" • (1) 7/64" • (2) 1/8" • (1) 9/64" • (1) 5/32" • (1) 3/16" • (1) 7/32" • (1) 1/4" • (1) 5/16" • (1) 3/8" • (1) 1/2"	B-65399

Description	Part #
11-Pc. Torsion Magnetic Insert Bit Set Includes: • (1) Torsion Magnetic Insert Bit Holder • (10) #2 1" Phillips Insert Bit	B-35112

Description	Part #
7-Pc. Double-Ended Power Bits with Mag Boost Includes: • (1) Mag Boost • (3) #2 2-1/2" Phillips Double-Ended Power Bit • (2) #2 3-1/2" Phillips Double-Ended Power Bit • (1) #2 6" Phillips Double-Ended Power Bit	B-44987

DOUBLE-ENDED POWER BITS



Description	Length	Qty./Pkg.	Part #
Phillips Double-Ended Power Bit	#1	2-1/2"	3 B-39578
	#2	2-1/2"	3 B-39584
	#3	2-1/2"	3 B-39590
Phillips Double-Ended Power Bit	#1	3-1/2"	1 B-39609
	#2	3-1/2"	1 B-39615
	#3	3-1/2"	1 B-39621
	#2	6"	1 B-39637

Description	Part #
3-Pc. 2-1/2" Square Double-Ended Power Bit Sets Includes: (1) Square #1 Double-Ended Power Bit (1) Square #2 Double-Ended Power Bit (1) Square #3 Double-Ended Power Bit	B-49600

Description	Part #
3-Pc. 2-1/2" Torx® Double-Ended Power Bit Sets Includes: (1) #15 Torx® Double-Ended Power Bit (1) #20 Torx® Double-Ended Power Bit (1) #25 Torx® Double-Ended Power Bit	B-49616



Description	Part #
3-Pc. Combination 2-1/2" Double-Ended Power Bit Sets Includes: (1) #2 Phillips / #2 Square Double-Ended Power Bit (1) #2 Phillips / #25 Torx® Double-Ended Power Bit (1) #2 Square / #25 Torx® Double-Ended Power Bit	B-49622

PHILLIPS POWER BITS			
Description	Length	Qty./Pkg.	Part #
Phillips #2 Power Bits	2"	2	B-60492
	2"	15	B-60523

TORX® POWER BIT			
Description	Length	Qty./Pkg.	Part #
T25 Torx® Power Bit	2"	2	B-60517
	2"	15	B-60545

SQUARE RECESS POWER BITS			
Description	Length	Qty./Pkg.	Part #
Square Recess Power Bits	2"	2	B-60501
	2"	15	B-60539

INSERT BITS

Description	Length	Application	Qty./Pkg.	Part #
Phillips Insert Bit 	#1 1"	Ideal for driving screws in a wide variety of heavy-duty fastening applications including deck building, framing and installing plywood subfloor	4	B-34936
	#2 1"		4	B-34942
	#2 1"		15	B-34958
	#2 1"		100	B-42569
	#3 1"		4	B-34964
Torx® Insert Bit 	#10 1"	2	B-44644	
	#15 1"	2	B-44650	
	#20 1"	2	B-44666	
	#25 1"	2	B-44672	
	#25 1"	25	B-44731	
	#27 1"	2	B-44688	
	#30 1"	2	B-44694	
Square Insert Bit 	#1 1"	2	B-44703	
	#2 1"	2	B-44719	
	#2 1"	25	B-44747	
	#3 1"	2	B-44725	

- Engineered with Xtreme Torsion Technology to handle the high torque of leading impact drivers
- Precision-fit tip prevents "cam-out" and stripping
- Lasts up to 60X longer than standard insert bits
- Combine with an Impact GOLD® bit holder to last up to 15X longer than standard insert bits

Insert Bit Holders



Description	Length	Qty./Pkg.	Part #
Ultra Magnetic Torsion Insert Bit Holder	2-3/4"	1	B-35097
Torsion Magnetic Insert Bit Holder	2-5/8"	1	B-35106

- Engineered with Xtreme Torsion Technology to handle the high torque of leading impact drivers
- Combine with an Impact GOLD® Insert Bit to last up to 15X longer than standard insert bits
- High-quality steel for extra strength
- Ideal for driving screws in a wide variety of heavy-duty fastening applications including deck building, framing and installing plywood subfloor

MAG BOOST

Description	Fits	Part #
 Mag Boost	1/4" hex power bits	B-44971

- Makes power bits magnetic
- 17X more magnetic than standard bits
- Great for holding screws to the end of the bit in tight or long reach situations
- Fits most brand 1/4" hex power bits

MAG BOOST
XTREME HOLDING POWER

MAG BOOST
holds 100 standard ball bearings



17X
MORE MAGNETIC THAN STANDARD BITS



NO MAG BOOST
holds only 6 standard ball bearings



NUTSETTERS

Description	Size	Length	Qty./Pkg.	Part #
 Nutsetter	5/16"	1-7/8"	1	B-35047
	5/16"	1-7/8"	10	B-42684
	3/8"	1-7/8"	1	B-35053
	3/8"	1-7/8"	10	B-42690
	7/16"	1-7/8"	1	B-35069
	7/16"	1-7/8"	10	B-42709
 Detachable Nutsetter	1/4", 5/16", 3/8"	2-1/2"	1	B-61581

GRIP-IT™
NUTSETTER
Impact GOLD®



Non-magnetic ring eliminates debris build-up



STANDARD MAGNETIC



Collects debris and obstructs proper fit



SOCKET ADAPTERS & SOCKET SETS

Description	Drive	Shank	Part #
 Socket Adapter	3/8"	1/4" Hex	B-35075
	1/2"	1/4" Hex	B-35081

- Socket adapter tilts up to 15° for work in tight spaces
- Also works in the straight position for increased versatility
- High-quality steel for extra strength
- Allows the use of square drive impact sockets with an impact driver
- Ideal for a wide variety of fastening applications

Description	Part #
9-Pc. 3/8" Drive Impact Socket Set w/ 15° Tilt Socket Adapter Includes: 3/8" Drive x 1/4" Socket Adapter, 5/16", 3/8", 7/16", 1/2", 9/16", 5/8", 11/16" and 3/4" Impact Sockets	B-34833
9-Pc. 3/8" Drive Metric Socket Set w/ 15° Tilt Socket Adapter Includes: 3/8" Drive x 1/4" Socket Adapter, 8mm, 10mm, 12mm, 13mm, 14mm, 15mm, 17mm and 18mm Impact Sockets	B-49862

IMPACT SOCKET ADAPTER

TILTS 15° for Tight Work Areas

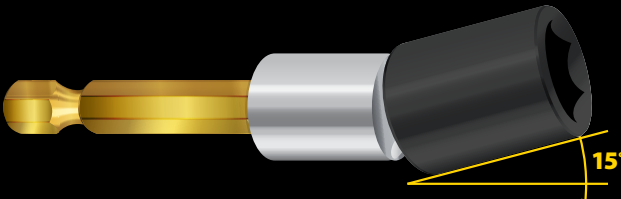

EASY OVERHEAD FASTENING STREAMLINED

Speed. Convenience. Comfort. Durability.

FASTENING

Hollow socket accelerates fastening over extra long bolts and all thread, NO MORE HAND-THREADING

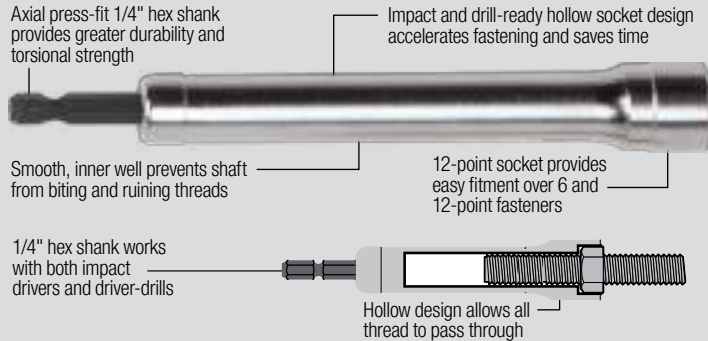

Socket Size	Length	Part #
9/16"	3"	B-43290
	6"	B-43309
	12"	B-43315
	18"	B-43321
	24"	B-43337
3/4"	3"	B-43343
	6"	B-43359
	12"	B-43365
	18"	B-43371
	24"	B-43387

DRILL & DRIVER BIT SETS

Description	Part #
70-Pc. Impact Drill & Driver Set Includes: (1) Magnetic Bit Holder (2) 1/4" Socket Adapters: 1/4" and 3/8" Drive (3) Magnetic Nutsetters: 1/4", 5/16", 3/8" (2) 4" Wood Boring Drill Bits: 1/2", 3/4" (7) 1/4" Hex Shank Drill Bits: 2 x 1/16", 3/32", 2 x 1/8", 3/16", 1/4" (41) 1" Insert Bits: Phillips, Slotted, Robertson, Torx® (9) 2" Power Bits: Phillips, Robertson, Torx® (5) 3-1/2" Power Bits: Phillips, Robertson	T-01725

Description	Part #
66-Pc. Contractor Bit Set Includes: (5) HSS Metal Drill Bits: 1/8", 9/64", 5/32", 3/16", 1/4" (5) Brad Point Wood Drill Bits: 1/8", 3/16", 1/4", 5/16", 3/8" (3) Spade Bits: 3/8", 1/2", 5/8" (5) 2" Magnetic Nutsetters: 1/4", 5/16", 3/8", 7/16", 1/2" (1) 1/4" Hex Shank Magnetic Bit Holder (1) 1/4" Hex Shank Quick-Change Bit Holder (10) #2 2" Phillips Power Bits (36) 1" Insert Bits: (2) #1 Phillips (1) #6-8 Slotted (4) #20 Torx® (8) #2 Phillips (1) #8-10 Slotted (4) #25 Torx® (2) #3 Phillips (1) #10-12 Slotted (2) #27 Torx® (1) #1 Square (1) #10 Torx® (2) #30 Torx® (4) #2 Square (1) #15 Torx® (1) #40 Torx® (1) #3 Square	B-51661

Description	Part #
38-Pc. Impact Drill & Driver Set Includes: (4) Black Oxide Drill Bits: 1/16", 3/32", 1/8", 1/4" (21) 1" Insert Bit Assortment: Slotted, Phillips, Robertson and Torx® (6) 2" Power Bits (3) 3-1/2" Power Bits (1) 1/4" Drive x 1/4" Socket Adapter (1) Magnetic Bit Holder (2) Magnetic Nutsetters: 1/4", 5/16"	T-01373

SOCKET SET

Description	Part #
8-Pc. 1/4" 6-Point Socket Set Includes: 3/16", 1/4", 5/16", 3/8", 7/16", 1/2", 9/16" Impact Sockets & 1/4" Socket Adapter	T-02369



1/2" DRIVE DEEP WELL IMPACT SOCKETS

Description	Diameter	Drive	Part #
1/2" Drive Deep Well Impact Sockets High-quality steel engineered for use in high torque applications. Chromium-Molybdenum Steel (CRMO) construction for added durability and long life. Locking hole keeps the socket securely attached to the impact. Laser etched for easy identification.	3/8"	1/2"	A-96235
	7/16"		A-96241
	1/2"		A-96257
	9/16"		A-96263
	5/8"		A-96279
	11/16"		A-96285
	3/4"		A-96291
	13/16"		A-96300
	7/8"		A-96316
	15/16"		A-96322
	1"		A-96338
	1-1/16"		A-96344
	1-1/8"		A-96350



14 Pc. 1/2" Drive Deep Well Impact Socket Set
Includes: 7/16", 1/2", 9/16", 5/8", 11/16", 3/4", 13/16", 7/8", 15/16", 1", 1-1/16", 1-1/8", 1-3/16", 1-1/4"

3/8" DRIVE DEEP WELL IMPACT SOCKETS

Description	Diameter	Drive	Part #
3/8" Drive Deep Well Impact Sockets High-quality steel engineered for use in high torque applications. Chromium-Molybdenum Steel (CRMO) construction for added durability and long life. Locking hole keeps the socket securely attached to the impact. Laser etched for easy identification.	1/4"	3/8"	A-99518
	5/16"		A-99524
	11/32"		A-99530
	3/8"		A-99546
	7/16"		A-99552
	1/2"		A-99568
	9/16"		A-99574
	5/8"		A-99580
	11/16"		A-99596
	3/4"		A-99605
	13/16"		A-99611
	7/8"		A-99627
	15/16"		A-99633

14 Pc. 3/8" Drive Deep Well Impact Socket Set
Includes: 1/4", 5/16", 11/32", 3/8", 7/16", 1/2", 9/16", 5/8", 11/16", 3/4", 13/16", 7/8", 15/16", 1"

DRYWALL NOSE ADAPTER

Description	Model	Part #
Nose Piece Assembly Converts impact driver to adjustable depth screwdriver. Must be used with magnetic insert bit holder (A-96942) and insert bits.	XDT01, XDT04 XDT08, XDT09 XDT11, XDT12 XDT13, XDT14	194633-2



COUNTERSINK DRILL BITS

DRILLS PILOT HOLES, COUNTERSINKS & COUNTERBORES FOR SCREWS

In One Easy Operation for a Flush Finish in Wood



COUNTERSINK
Pre-drills hole for the fastener and prevents the workpiece from splitting



SUPERIOR RESULTS
Four cutting edges are designed to leave a clean finish in hard and soft woods

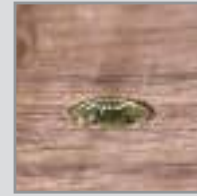

FINISHED PRODUCT
The fastener is able to be flush to or below the finished surface

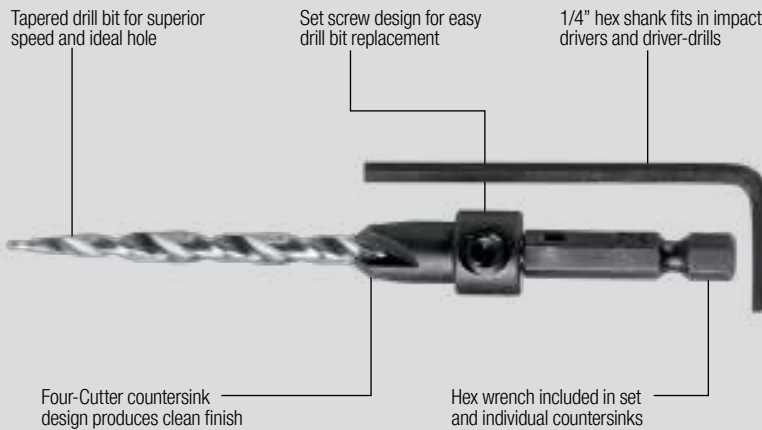

Description	Drill Size	Part #
3-pc. (#6, #8, #10) Countersink with drill bit set (with Hex wrench)	9/64", 11/64", 3/16"	A-99661
#6 Countersink with drill bit (with Hex wrench)	9/64"	A-99677
#8 Countersink with drill bit (with Hex wrench)	11/64"	A-99683
#10 Countersink with drill bit (with Hex wrench)	3/16"	A-99699
#12 Countersink with drill bit (with Hex wrench)	7/32"	A-99708
#6 Countersink replacement drill bit	9/64"	A-99714
#8 Countersink replacement drill bit	11/64"	A-99720
#10 Countersink replacement drill bit	3/16"	A-99736
#12 Countersink replacement drill bit	7/32"	A-99742

DRILL CHUCK & IMPACT CHUCKS

Description	Capacity	Model	Part #
Keyless Chuck Thread Size: 3/8" - 24	3/8"	6226DWE, 6227DWE, 6228DWE, DA312DWD, DA391DW, DA392DWD	763132-1
		6176DW	763184-2
		6213D	193692-3
		6217DWDE	193690-7
		FD02	766007-3
		FD07	763238-5
Thread Size: 1/2" - 20	1/2"	BDA341, BDA351, XAD01, XAD02	766005-7
		BHP451, BDF451	763191-5
		BDF452, BDF452HW, BHP452, BHP452HW, XPH01, XPH10, XFD01, XFD10	763193-1
		LXFD01, XFD01, XFD11	766027-7
		LXPH03, XPH03	766015-4
		HP2070F	193822-6
		NHP1310	763047-2

Description	Capacity	Shank	Model	Part #
Keyless Chuck Attachment Converts Impact Driver into Driver-Drill	3/8"	1/4" Hex	1/4" Hex Shank Impact Drivers	763198-1
Keyless Chuck Attachment Converts Key Drill Chuck into Keyless Chuck	3/8"	1/4" Hex	Cordless Driver-Drills	192077-0
Keyed Drill Chuck Attachment Set	3/8"	1/4" Hex		191881-4
Keyed Drill Chuck Only	3/8"	1/4" Hex	Cordless Impact	763054-5A
Replacement Shank	3/8"	1/4" Hex		784643-3

Description	Model	Part #
Chuck Key	DA3000, DA3000R	763414-1
	6093D	763419-1
	HP1640	763440-0
	HP2010N	798341-3

DRILL BITS

Black Oxide Drill Bits

- Designed exclusively for high-torque impact drivers
- 135° split point geometry for fast starts and reduced walking
- 1/4" hex shank works directly with impact drivers and driver-drills
- Durable one piece design
- Black oxide coating for added corrosion resistance
- High Speed Steel (HSS) construction for added durability and long life
- For drilling holes in ferrous metal, wood, plastic, non-ferrous metal and cast iron



Diameter	Length	Shank	Part #
1/8"	2-9/16"	1/4" Hex	A-97748
9/64"	2-3/4"		A-97754
5/32"	2-3/4"		A-97760
11/64"	2-15/16"		A-97776
3/16"	2-15/16"		A-97782
13/64"	3"		A-97798
7/32"	3"		A-97807
1/4"	3-1/8"		A-97813
5/16"	3-15/16"		A-97829
3/8"	3-15/16"		A-97835
1/2"	3-15/16"		A-97841

Titanium Bits

- 135° split point geometry for fast starts and reduced walking
- Titanium nitride (TiN) coating lasts 2.5X longer than non-coated bits
- Fully ground for easy chip removal and long life



Diameter	Length	Shank	Part #
1/8"	3-15/32"	1/4" Hex	D-23880
5/32"	3-13/16"	1/4" Hex	D-23905
3/16"	4-7/32"	1/4" Hex	D-23911
1/4"	4-3/4"	1/4" Hex	D-23927
5/16"	4-1/2"	1/4" Hex	D-23933
3/8"	5"	1/4" Hex	D-23949



Description	Part #
5-Pc. Set Includes: 1/8", 5/32", 3/16", 1/4", 5/16"	D-35318

Masonry Bits

- Hex shank design for quick and convenient bit changes
- For drilling holes in masonry and brick



Diameter	Length	Shank	Part #
1/8"	3"	1/4" Hex	D-24038
3/16"	3-11/32"	1/4" Hex	D-24044
1/4"	4"	1/4" Hex	D-24050

5 Pc. Masonry and Metal Drill Bit Set 1/4" Hex Shank

- Includes bits for drilling in metal and masonry materials



Description	Part #
5-Pc. Hex Set Includes: 3/16", 1/4" (Masonry) 1/8", 3/16", 1/4" (Metal/Wood)	D-23765

Forstner Bits

- For drilling clean, chip-free holes in wood
- Large gullets provide exceptional chip clearance
- Sharp center spur accurately locates the center of hole



Diameter	Shank	Length	Part #
1/4"	3/8"	3-1/2"	733308-A
3/8"	3/8"	3-1/2"	733309-A
1/2"	3/8"	3-1/2"	733310-A
5/8"	3/8"	3-1/2"	733311-A
3/4"	3/8"	3-1/2"	733312-A
7/8"	3/8"	3-1/2"	733313-A
1"	3/8"	3-1/2"	733314-A
1-1/8"	3/8"	3-1/2"	733315-A
1-1/4"	3/8"	3-1/2"	733316-A
1-3/8"	3/8"	3-1/2"	733317-A
35mm	3/8"	3-1/2"	733324-A
1-1/2"	3/8"	3-1/2"	733318-A
1-5/8"	3/8"	3-1/2"	733319-A
1-3/4"	3/8"	3-1/2"	733320-A
1-7/8"	3/8"	3-1/2"	733321-A
2"	3/8"	3-1/2"	733322-A
2-1/8"	3/8"	3-1/2"	733323-A

Self Feed Bits

- Used by plumbers, electricians and other tradesmen for boring holes for pipe and conduit in wood
- Outlining spurs accurately define hole diameter
- Threaded screw point pulls the bit into the work providing a fast, easy to use self feeding action
- 7/16" heavy-duty shank



Diameter	For Pipe Diameter	Part #
1"		D-29935
1-1/8"	1/2"	D-29957
1-1/4"	3/4"	D-29963
1-3/8"		D-29979
1-1/2"	1"	D-29985
1-3/4"	1-1/4"	D-29991
2"		D-30003
2-1/8"	1-1/2"	D-30019
2-1/4"		D-30025
2-9/16"	2"	D-30031
3"		D-30047

Description	Part #
Double ended screw point for bit 1" to 3"	D-30156

Heavy Duty Spade Bits

- Spurs cut cleaner, more accurate holes through hardwood
- Chisel edge design is angled aggressively to dig into wood



Diameter	6-1/8" Length Part #	16" Length Part #
1/4"	714154-A	
5/16"	714155-A	
3/8"	714156-A	714147-A
7/16"	714157-A	
1/2"	714158-A	714148-A
9/16"	714159-A	
5/8"	714160-A	714150-A
11/16"	714161-A	
3/4"	714162-A	714151-A
13/16"	714163-A	
7/8"	714164-A	714152-A
15/16"	714165-A	
1"	714166-A	714153-A
1-1/8"	714167-A	
1-1/4"	714168-A	
1-3/8"	714169-A	
1-1/2"	714170-A	



Set Description	Part #
6-Pc. Set Includes: 3/8", 1/2", 5/8", 3/4", 7/8", 1"	714171-A

Ship Augers

- Features quick release hex shank for fast insertion or removal
- Cutting edge quickly cuts through wood with maximum efficiency
- Thick edge easily cuts through nails



Diameter	Length	Shank	Part #
3/8"	6"	5/16" Hex	D-35673
1/2"	6"	5/16" Hex	D-35695
5/8"	6"	7/16" Hex	D-35710
11/16"	6"	7/16" Hex	D-35726
3/4"	6"	7/16" Hex	D-35732
13/16"	6"	7/16" Hex	D-35748
7/8"	6"	7/16" Hex	D-35754
15/16"	6"	7/16" Hex	D-35760
1"	6"	7/16" Hex	D-35776
1-1/16"	6"	7/16" Hex	D-35782
1-1/8"	6"	7/16" Hex	D-35798
1-1/4"	6"	7/16" Hex	D-35807
1-3/8"	6"	7/16" Hex	D-35813
1-1/2"	6"	7/16" Hex	D-35829
7/16"	18"	5/16" Hex	D-35841
1/2"	18"	5/16" Hex	D-35857
9/16"	18"	7/16" Hex	D-35863
5/8"	18"	7/16" Hex	D-35879
11/16"	18"	7/16" Hex	D-35885
3/4"	18"	7/16" Hex	D-35891
13/16"	18"	7/16" Hex	D-35900
7/8"	18"	7/16" Hex	D-35916
15/16"	18"	7/16" Hex	D-35922
1"	18"	7/16" Hex	D-35938
1-1/16"	18"	7/16" Hex	D-35944
1-1/8"	18"	7/16" Hex	D-35950
1-1/4"	18"	7/16" Hex	D-35966
1-3/8"	18"	7/16" Hex	D-35972
1-1/2"	18"	7/16" Hex	D-35988

Ship Auger Extensions

- Set screw design ensures a tight connection in the most demanding of applications
- Attaches to hex shank drill bits to allow deeper drilling in wood
- High strength steel construction for long life



Length	Shank	Part #
5-1/2"	7/16" Hex	D-35645
12"	7/16" Hex	D-35651
18"	7/16" Hex	D-35639

HOLE SAWS

Bi-Metal Hole Saws



1 2 3 Use below with Arbor #: 714060-B, 714061-A or 714062-B which have 1/2" – 20 thread

Description	Pipe Entrance Size	Pipe Tap Size	Mild Steel RPM	Box Part #
5/8"			530	714002-A
3/4"			460	714004-A
7/8"	1/2"	3/4"	390	714006-A
15/16"			370	714007-A
1"			350	714008-A
1-1/16"			325	714009-A
1-1/8"	3/4"	1"	300	714010-A
1-3/16"			285	714011-A

4 5 Use below with Arbor #: 714063-A or 714065-A which have 5/8" – 18 thread

Description	Pipe Entrance Size	Pipe Tap Size	Mild Steel RPM	Box Part #
1-1/4"			275	714012-A
1-5/16"			260	714013-A
1-3/8"	1"		250	714014-A
1-1/2"		1-1/4"	230	714016-A
1-5/8"			210	714018-A
1-3/4"	1-1/4"	1-1/2"	195	714020-A
1-7/8"			180	714022-A
2"	1-1/2"		170	714023-A
2-1/16"			165	714024-A
2-1/8"			160	714025-A
2-1/4"		2"	150	714026-A
2-3/8"			140	714028-A

5 Use below with Arbor #: 714065-A which has 5/8" – 18 thread

Description	Pipe Entrance Size	Pipe Tap Size	Mild Steel RPM	Box Part #
2-1/2"	2"		135	714029-A
2-5/8"		2-1/2"	130	714031-A
2-3/4"			125	714032-A
2-7/8"			120	714033-A
3"	2-1/2"		115	714034-A
3-1/8"			110	714035-A
3-1/4"		3"	105	714036-A
3-1/2"			95	714038-A
3-5/8"	3"		95	714039-A
3-3/4"		3-1/2"	90	714040-A
4"			85	714042-A
4-1/8"	3-1/2"		85	714043-A
4-1/4"			80	714044-A
4-1/2"	4"		75	714046-A
4-3/4"		4-1/2"	70	714047-A
5"			65	714048-A
6"			55	714050-A

Arbors with Pilot Drill

	Thread Size	Shank	Box Part #
1	1/2" – 20	1/4" Round	714060-A
2	1/2" – 20	3/8" Hex	714061-A
3	1/2" – 20	7/16" Hex	714062-A
4	5/8" – 18	3/8" Hex	714063-A
5	5/8" – 18	7/16" Hex	714065-A



Description	Part #
12" Extension for 7/16" Shank Arbors	714067-A



Description	Part #
Replacement Pilot Drill	2-3/4" x 1/4" 714069-A 4-1/2" x 1/4" 714068-A
Adapter Nut converts 1/2" - 20 (hex shanks) to 5/8" - 18	714059-A

Keyless Chuck Attachment

- Converts 1/4" hex impact driver into a 3/8" keyless chuck
- Designed to accept round and hex shank bits
- For converting an impact driver into a driver drill



Description	Part #
Converts 1/4" hex impact driver into 3/8" keyless chuck	763198-1

High Speed Steel Step Drill Bits

- Drills perfectly round holes in materials such as steel, brass, plastic, and wood
- Ideal for knockouts in electrical junction boxes and cabinets
- Efficiently enlarges and deburs holes
- 1/4" hex shank works directly with impact drivers and driver-drills



Increments	Shank	Part #
1/8", 5/32", 3/16", 7/32", 1/4", 9/32", 5/16", 11/32", 3/8", 13/32", 7/16", 15/32", 1/2"	1/4"	711492-A
1/4", 5/16", 3/8", 7/16", 1/2", 9/16", 5/8", 11/16", 3/4"	1/4"	711493-A
1/4", 7/8", 1-1/8"	1/4"	711494-A
1/4", 1/2"	1/4"	711495-A
1/4", 7/8"	1/4"	711496-A
9/16", 5/8", 11/16", 3/4", 13/16", 7/8", 15/16", 1"	1/4"	711497-A

INDUSTRIAL CARBIDE-TIPPED HOLE SAWS

Cobalt center bit ideal for use in metal including stainless steel, galvanized iron and aluminum

Specially designed carbide tips for cutting clean holes

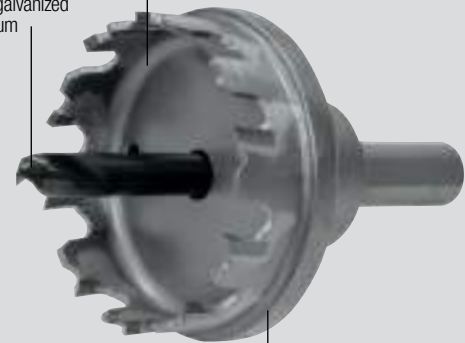

Shoulder engineered to prevent "punching through" the material



- Lasts 15X longer and drills 2.6X faster than bi-metal hole saws
- Specially designed carbide tips for cutting clean holes
- Max. cutting depth of 1/8" with 2-1/2" overall length

Diameter	Part #	Center Bits Type C Part #
5/8"	714070-A	
3/4"	714071-A	
7/8"	714073-A	
1"	714074-A	
1-1/8"	714075-A	
1-1/4"	714077-A	
1-3/8"	714078-A	
1-1/2"	714079-A	
1-3/4"	714080-A	
2"	714081-A	
2-1/8"	714092-A	
2-1/4"	714082-A	
2-1/2"	714083-A	
3"	714085-A	

Expandable Range of Applications Type "C": Cobalt (Included)

- Stainless Steel
- Galvanized Iron
- Aluminum, etc.

STAYS SHARPER LONGER

Engineered to Self-Sharpen for Continuous Breaking



Self-sharpening design keeps the point sharp longer than traditional bits

16" Self-Sharpening Bull Point, 1-1/8" Hex (B-45559)

Improved geometry for faster penetration and more efficient breaking

DEMOLITION & ROTARY HAMMER STEEL

	1-1/8" Hex		Makita® Large		3/4" Hex		SDS-MAX		Splines or 3/4" Hex - 21/32" Round		Makita® Small		SDS-PLUS	
	Size	Part #	Size	Part #	Size	Part #	Size	Part #	Size	Part #	Size	Part #	Size	Part #
Bull Point All-purpose demolition and starting holes in concrete	20-1/2" 16"	D-21353 Also fits air tools B-45559 Self-Sharpening	16"	798029-5	12" 18"	751421-A 751422-A	12" 12" 18" 18"	751423-A D-36463 751424-A D-36479	12" 18"	D-20074 D-19196	8-3/4"	B-06921	10"	D-51144
Flat Chisel General purpose chipping, edging, and channeling	1-1/8" x 20-1/2"	D-21369 Also fits air tools	1-3/8" x 16"	A-80597	1" x 12" 1" x 18"	751224-A 751225-A	1" x 12" 1" x 12" 1" x 18" 1" x 18"	751228-A D-36485 751231-A D-36491	1" x 12" 1" x 18"	D-20080 D-19205			3/4" x 10"	D-51150
Scaling Chisel Wide chisel with two cutting angles for chipping dried concrete	3" x 20-1/2"	D-21347 Also fits air tools	4" x 12"	D-23868	3" x 12"	751226-A	1-1/2" x 12" 2" x 12" 2" x 12" 3" x 12" 3" x 12"	751235-A 751229-A D-36516 751230-A D-36522	2" x 12" 3" x 12"	D-51172 751233-A	1-3/16" x 6" 2" x 6" 2" x 9"	B-07331 B-07347 B-07010	2" x 8-1/2"	D-51166
Superkut Chisel Long-lasting chisel provides faster penetration and requires less resharpening	1-1/2" x 20-1/2"	751222-A												
Scraping Chisel Scrapes and chisels with 45° cutting angle					2" x 12"	751227-A	2" x 12"	751232-A	2" x 12"	751234-A				
Floor Scraper General scraping and clean-up of tile, linoleum floor							6" Floor Scraper 6" Blade & Hardware	T-02593 T-02602			4" Blade & Assembly 4" Blade Only	A-43022 343411-9	4" Blade & Assembly 4" Blade Only	A-30106 343411-9
One-Piece Bushing Tool Removes excess concrete and roughens surface	1-3/4" x 14-3/4"	751717-A			1-3/4" x 9-3/4"	751714-A	1-3/4" x 10"	751715-A	1-3/4" x 10"	798144-5				
Asphalt Cutter Cuts asphalt or hard ground (not for concrete)	5" x 17-1/2"	751620-A			5" x 15"	751624-A	5" x 15"	751625-A						
Digging Chisel Digs deep into hard ground and asphalt	3" x 22-1/2"	751621-A												
Clay Spade Digs clay, shale, hard-packed gravel, and dirt	5-1/2" x 20"	751622-A			4-1/2" x 17"	751623-A	4-1/2" x 17"	751626-A	4-1/2" x 17"	798148-7				
Pointed Spade Breaks clay, dirt, and hard ground quickly			4-3/4" x 19"	B-10300	4-1/2" x 16"	751107-A								
Ground Rod Driver Drives ground rods into the ground	1" I.D. x 2-1/4" x 16"	751102-A			3/4" I.D. x 2-3/4" x 10"	751105-A	3/4" I.D. x 2-3/4" x 10"	751108-A	3/4" I.D. x 2-3/4" x 10"	751109-A	13/16" Ground Rod Driver	798132-2		
Spike/Pin Driver Drives spikes, anchoring pins, tent stakes, and more	1-3/4" I.D. x 14-1/2"	751101-A												
Tamper Shank Tamps asphalt and compacts dirt (use with corresponding plate)	15-1/2"	751103-A												
Tamper Plate Tamps asphalt and compacts dirt (use with tamper shank)	6" x 6" Square 8" x 8" Square	751710-A 751711-A	7-7/8" Round (Shank & Plate)	A-31485										

NEW

SDS-MAX DUST EXTRACTION DRILL BITS

DUST MANAGEMENT

Features dust extraction holes for removal of dust from the hole while drilling

DESIGN

Dust evacuation increases drilling speed and improves drill bit life

PRODUCTIVITY

Reduces airborne silica dust and offers increased productivity during chemical anchor installation

COMPATIBILITY

Fits most common dust extractor vacuums

	Diameter	Usable Length	Overall Length	Part #
--	----------	---------------	----------------	--------

SDS-MAX Dust Extraction Drill Bit



B-63937 shown

1/2"	15-3/4"	24"	B-63828
9/16"	15-3/4"	24"	B-63834
5/8"	15-3/4"	24"	B-63840
3/4"	15-3/4"	24"	B-63862
7/8"	15-3/4"	24"	B-63884
1"	15-3/4"	24"	B-63890
1-1/8"	15-3/4"	24"	B-63909
1-3/8"	15-3/4"	24"	B-63937

Vacuum Attachment



- Replacement vacuum attachment for Makita® SDS-MAX Dust Extraction Drill Bits
- Fits most common dust extractor vacuums
- For use with Makita® SDS-MAX dust extraction drill bits

SDS-MAX DEMOLITION STEEL

	Description	Size	Part #
--	-------------	------	--------



Bull Point

12"
18"

751423-A
751424-A



Flat Chisel

1" x 12"
1" x 18"

751228-A
751231-A



Scaling Chisel

1-1/2" x 12"
2" x 12"
3" x 12"

751235-A
751229-A
751230-A



Scraping Chisel

2" x 12"

751232-A



One-Piece Bushing Tool

1-3/4" x 10"

751715-A



Asphalt Cutter

5" x 15"

751625-A



Clay Spade

4-1/2" x 17"

751626-A



Ground Rod Driver

3/4" I.D. x
2-3/4" x 10"

751108-A

SDS-MAX GENERAL PURPOSE DEMOLITION STEEL

	Description	Size	Part #
--	-------------	------	--------



Bull Point

12"
18"

D-36463
D-36479



Flat Chisel

1" x 12"
1" x 18"

D-36485
D-36491



Scaling Chisel

2" x 12"
3" x 12"

D-36516
D-36522



Manufactured using state-of-the-art technology CNC machined and forged from a tough alloy material for increased durability and product longevity

CARBIDE STEEL / DEMOLITION STEEL

NEW

SDS-MAX CARBIDE DRILL BITS

	Diameter	Usable Length	Overall Length	Part #
--	----------	---------------	----------------	--------

SDS-MAX Bits 2-Cutter



1/2"	8"	13"	B-61307
1/2"	16"	21"	B-61313
9/16"	8"	13"	B-61329
9/16"	16"	21"	B-61335

SDS-MAX Bits 6-Cutter



5/8"	8"	13"	B-61341
5/8"	16"	21"	B-61357
5/8"	31"	36"	B-61363
11/16"	16"	21"	B-61379
3/4"	8"	13"	B-61385
3/4"	16"	21"	B-61391
3/4"	31"	36"	B-61400
13/16"	16"	21"	B-61416
7/8"	8"	13"	B-61422
7/8"	16"	21"	B-61438
7/8"	31"	36"	B-61444
1"	8"	13"	B-61450
1"	16"	21"	B-61466
1"	31"	36"	B-61472
1-1/8"	8"	13"	B-61488
1-1/8"	16"	21"	B-61494
1-1/8"	31"	36"	B-61503
1-1/4"	8"	13"	B-61519
1-1/4"	16"	21"	B-61525
1-1/4"	31"	36"	B-61531
1-3/8"	16"	21"	B-61547
1-3/8"	31"	36"	B-61553
1-1/2"	16"	21"	B-61569
1-1/2"	31"	36"	B-61575

- 6 cutting edges for maximum performance and rounder holes
- 6-cutter bit tip is engineered for drilling in reinforced concrete
- Centering tip features a more aggressive design for faster hole starting



NEW

SDS-MAX CORE BITS

	Description	Usable Length	Overall Length	Part #
--	-------------	---------------	----------------	--------



9" SDS-MAX Rotary Hammer Core Bit Shank Adapter

3"
4"

B-66612



16-1/2" SDS-MAX Rotary Hammer Core Bit Shank Adapter

3"
4"

B-66628

1-3/4" Rotary Hammer Core Bit

3"
4"

B-66634

2" Rotary Hammer Core Bit

3"
4"

B-66640

2-5/8" Rotary Hammer Core Bit

3"
4"

B-66656

3-1/8" Rotary Hammer Core Bit

3"
4"

B-66662

4" Rotary Hammer Core Bit

3"
4"

B-66678

5" Rotary Hammer Core Bit

3"
4"

B-66684

6" Rotary Hammer Core Bit

3"
4"

B-66690

7/16" x 4-1/2" Rotary Hammer Core Bit Centering Bit

3-1/2"
4-1/2"

B-66709



Rotary Hammer Core Bit Drift Pin

-
-

B-66715

SDS-MAX FLOOR SCRAPER

	Description	Size	Part #
--	-------------	------	--------



Floor Scraper

6"
T-02593



Blade and Hardware Only

6"
T-02602

SDS-PLUS CARBIDE DRILL BITS

Diameter	Usable Length	Overall Length	Part #
5/32"	4"	6"	B-60551
3/16"	2"	4"	B-60567
3/16"	4"	6"	B-60573
3/16"	10"	12"	B-60589
7/32"	4"	6"	B-60595
1/4"	2"	4"	B-60604
1/4"	4"	6"	B-60610
1/4"	10"	12"	B-60626
5/16"	4"	6"	B-60632
5/16"	10"	12"	B-60648
3/8"	4"	6"	B-60654
3/8"	10"	12"	B-60660
3/8"	16"	18"	B-60676
3/8"	22"	24"	B-60682
7/16"	10"	12"	B-60698
1/2"	4"	6"	B-60707
1/2"	10"	12"	B-60713
1/2"	22"	24"	B-60729
9/16"	4"	6"	B-60735
9/16"	10"	12"	B-60741
5/8"	6"	8"	B-60757
5/8"	10"	12"	B-60763
5/8"	22"	24"	B-60779
3/4"	6"	8"	B-60785
3/4"	10"	12"	B-60791
3/4"	22"	24"	B-60800
7/8"	10"	12"	B-60816
7/8"	16"	18"	B-60822
1"	8"	10"	B-60838
1"	16"	18"	B-60844
10 Packs			
5/32"	4"	6"	B-60850
3/16"	2"	4"	B-60866
3/16"	4"	6"	B-60872
1/4"	2"	4"	B-60888
1/4"	4"	6"	B-60894
5/16"	4"	6"	B-60903
3/8"	4"	6"	B-60919
3/8"	10"	12"	B-60925
1/2"	4"	6"	B-60931
1/2"	10"	12"	B-60947
5/8"	6"	8"	B-60953

5 Pc. SDS-PLUS Bit Set, 2-Cutter



- Set Includes: (1) 3/16" x 6", (1) 1/4" x 6", (1) 5/16" x 6", (1) 3/8" x 6", (1) 1/2" x 6" SDS-PLUS bits
- Self-centering carbide tip. Centering tip features a more aggressive design for faster hole starting
- Central guiding action engineered for more accurate holes

B-60969

SDS-PLUS METAL/WOOD DRILL BITS

Diameter	Usable Length	Overall Length	Part #
Metal			
1/8"	2-1/8"	3-7/8"	B-59106
9/64"	2-1/4"	4"	B-59112
5/32"	2-1/2"	4-1/4"	B-59128
11/64"	2-5/8"	4-3/8"	B-59134
3/16"	2-1/8"	4-5/8"	B-59140
13/64"	3-1/16"	4-3/4"	B-59156
7/32"	3-1/8"	4-7/8"	B-59162
15/64"	3-1/4"	5"	B-59178
1/4"	3-3/8"	5-3/16"	B-59184
Wood			
5/32"	2-5/16"	4-1/8"	B-59190
3/16"	2-7/8"	4-5/8"	B-59209
1/4"	3-1/2"	5-1/8"	B-59215
5/16"	3-15/16"	5-3/4"	B-59221
3/8"	4-1/2"	6-3/8"	B-59237

5 Pc. Assorted SDS-PLUS Drill Bit Set, Metal, Wood



- Set Includes: Brad Point Wood Bits: 3/16" x 4-5/8", 1/4" x 5-1/8" and HSS-G Metal Bits: 1/8" x 3-7/8", 3/16" x 4-5/8", 1/4" x 5-3/16"
- SDS-PLUS shank allows drilling in metal or wood without switching to a drill or using a special chuck adapter for operator convenience and productivity
- Metal drilling bits are made of Grounded High-Speed Steel (HSS-G) for longer life and feature 135° split point geometry for reduced walking

B-59243

Adapter, SDS-PLUS to 1/4" Hex



- Allows use of 1/4" Hex Bits on SDS-PLUS Rotary Hammers

B-59259

Diameter	Usable Length	Overall Length	Part #
3/16"	2"	4"	B-60975
3/16"	4"	6"	B-60981
3/16"	6"	8"	B-60997
3/16"	10"	12"	B-61008
1/4"	2"	4"	B-61014
1/4"	4"	6"	B-61020
1/4"	6"	8"	B-61036
1/4"	10"	12"	B-61042
5/16"	4"	6"	B-61058
5/16"	10"	12"	B-61064
3/8"	4"	6"	B-61070
3/8"	10"	12"	B-61086
3/8"	16"	18"	B-61092
1/2"	4"	6"	B-61101
1/2"	10"	12"	B-61117
1/2"	16"	18"	B-61123
5/8"	8"	10"	B-61139
5/8"	16"	18"	B-61145
3/4"	8"	10"	B-61151
3/4"	16"	18"	B-61167
10 Packs			
3/16"	2"	4"	B-61173
3/16"	4"	6"	B-61189
3/16"	6"	8"	B-61195
1/4"	2"	4"	B-61204
1/4"	4"	6"	B-61210
1/4"	6"	8"	B-61226
1/4"	10"	12"	B-61232
5/16"	4"	6"	B-61248
3/8"	4"	6"	B-61254
3/8"	10"	12"	B-61260
1/2"	4"	6"	B-61276
1/2"	10"	12"	B-61282

5 Pc. SDS-PLUS Bit Set, 3-Cutter



- Set includes (1) 3/16" x 6", (1) 1/4" x 6", (1) 5/16" x 6", (1) 3/8" x 6", (1) 1/2" x 6" SDS-PLUS bits
- 3 cutting edges for maximum performance and rounder holes
- 3-cutter bit tip is engineered for drilling in reinforced concrete

B-61298

Diameter	Usable Length	Overall Length	25/Pkg. Part #
5/32"	4"	6-1/4"	D-00810-25
3/16"	2"	4-1/2"	D-00826-25
3/16"	4"	6-1/4"	D-00832-25
3/16"	6"	8-1/4"	D-00848-25
7/32"	4"	6-1/4"	D-00854-25
1/4"	2"	4-1/2"	D-00860-25
1/4"	4"	6-1/4"	D-00876-25
1/4"	6"	8-1/4"	D-00882-25
5/16"	4"	6-1/4"	D-00907-25
3/8"	4"	6-1/4"	D-00929-25
3/8"	10"	12-1/4"	D-00935-25
1/2"	4"	6-1/4"	D-00963-25
1/2"	10"	12-1/4"	D-00979-25
5/8"	6"	8"	D-01002-25



25-Pack

- Engineered for reduced vibration and noise
- Central guiding action for accurate holes
- Special impact grade carbide



PERCUSSION CARBIDE DRILL BITS

Diameter	Usable Length	Overall Length	Part #
3/16"	2-1/2"	4"	711120-A
1/4"	2-1/2"	4"	711121-A
1/4"	3-1/2"	6"	711122-A
1/4"	11-1/2"	13"	711128-A
5/16"	3-1/2"	6"	711123-A
3/8"	3-1/2"	6"	711124-A
3/8"	11-1/2"	13"	711129-A
1/2"	3-1/2"	6"	711125-A
1/2"	11-1/2"	13"	711130-A
5/8"	3-1/2"	6"	711126-A
5/8"	11-1/2"	13"	711131-A
3/4"	3-1/2"	6"	711127-A
3/4"	11-1/2"	13"	711132-A





- Carbide-tipped for long life
- Wide flutes for rapid dust removal
- Re-sharpenable for extended life



SDS-PLUS DEMOLITION STEEL



- Manufactured using state-of-the-art technology
- CNC machined and forged from a tough alloy material for increased durability and product longevity

Description	Size	Part #
 Bull Point	10"	D-51144
 Flat Chisel	3/4" x 10"	D-51150
 Scaling Chisel	2" x 8-1/2"	D-51166
 Floor Scraper	4" x 10"	A-30106
 Blade Only	4"	343411-9

Adapter

- Allows the use of a standard Drill Chuck on SDS-PLUS Rotary Hammers
- Allows use of round shank Drill Bits when used in conjunction with a standard Drill Chuck
- Recommended for use with 1/2" Keyless Drill Chuck (763191-5)

Description	Part #
SDS-PLUS Chuck Adapter	D-14087









Dust Cup

- Captures dust when performing overhead drilling operations
- Fits up to 9/16" diameter bits

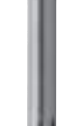

Description	Part #
SDS-PLUS Dust Cup	421342-3

NEW SPLINE CORE BITS

Description	Usable Length	Overall Length	Part #
 9" Spline Rotary Hammer Core Bit Shank Adapter"	3"	4"	B-66597
 16-1/2" Spline Rotary Hammer Core Bit Shank Adapter"	3"	4"	B-66606
 1-3/4" Rotary Hammer Core Bit"	3"	4"	B-66634
 2" Rotary Hammer Core Bit	3"	4"	B-66640
 2-5/8" Rotary Hammer Core Bit	3"	4"	B-66656
 3-1/8" Rotary Hammer Core Bit	3"	4"	B-66662
 4" Rotary Hammer Core Bit	3"	4"	B-66678
 5" Rotary Hammer Core Bit	3"	4"	B-66684
6" Rotary Hammer Core Bit	3"	4"	B-66690
7/16" x 4-1/2" Rotary Hammer Core Bit Centering Bit	3-1/2"	4-1/2"	B-66709
Rotary Hammer Core Bit Drift Pin	-	-	B-66715

SPLINE DEMOLITION STEEL



- Manufactured using state-of-the-art technology
- CNC machined and forged from a tough alloy material for increased durability and product longevity

Description	Size	Part #
 Bull Point	12" 18"	D-20074 D-19196
 Flat Chisel	1" x 12" 1" x 18"	D-20080 D-19205
 Scraping	2" x 12"	751234-A
 Scaling Chisel	2" x 12" 3" x 12"	D-51172 751233-A
 One-Piece Bushing Tool	1-3/4" x 10"	798144-5
 Clay Spade	4-1/2" x 17"	798148-7
 Ground Rod Driver	3/4" I.D. x 2-3/4" x 10"	751109-A

NEW SPLINE CARBIDE DRILL BITS

Diameter	Usable Length	Overall Length	Part #
2-Cutter			
3/8"	6-1/2"	12"	B-63959
1/2"	8"	13"	B-63965
1/2"	18"	23"	B-63971
9/16"	8"	13"	B-63987
6-Cutter			
5/8"	10"	16"	B-63993
5/8"	18"	24"	B-64004
3/4"	6-1/2"	12"	B-64010
3/4"	16"	21"	B-64026
3/4"	24"	29"	B-64032
3/4"	31"	36"	B-64048
7/8"	10"	16"	B-64054
7/8"	18"	24"	B-64060
1"	10"	16"	B-64076
1"	16"	21"	B-64082
1-1/8"	10"	16"	B-64098
1-1/8"	16"	21"	B-64107
1-1/4"	10"	16"	B-64113
1-1/4"	18"	24"	B-64129
1-3/8"	10"	16"	B-64135
1-3/8"	18"	24"	B-64141
1-1/2"	18"	24"	B-64157

Adapter, Spline-SDS-PLUS



- Expands the Versatility of your spline rotary hammer
- Allows the use of SDS-PLUS bits in Spline shank rotary hammers

B-64163

PREMIUM HAMMER CART

T-03224

- Large, rugged 10" semi-pneumatic wheels roll smoothly over rough job site terrain
- Stair climber rails for convenient lifting up stairs, curbs, truck beds and other elevated surfaces
- Adjustable strap keeps hammer securely fastened to the cart during transportation
- Convenient cord wrap keeps cord cleanly tucked away



HAMMER BIT GREASE

Description	Size	Part #
 For greasing the shanks of bits before installing them in the hammer	100ml	194683-7

For use with all brands and types of bits for rotary and demolition hammers

HAMMER GREASE

Description	Model	Part #
 30cc used to lubricate grease reservoir	All Hammers	A-90582

OIL SUPPLY

Description	Model	Part #
 Oil Supply 100 cc	HM1301	181118-7

BLOW-OUT BULB

Description	Model	Part #
 Blows chips and dust from drilled holes before setting anchor fasteners	All Hammers	765009-6

CUTTING CONCRETE JUST GOT EASIER Faster Cuts. Less Vibration. Longer Life.

Tensioned Laminate Plates



Improve balance, reduce resonance and limit vibration through the blade

Reinforced Core



Adds stability and works with the laminate plates to dampen vibration and noise



3D Diamond Grid Technology

Each diamond is placed in an even 3-dimensional pattern for unparalleled performance in lifetime and speed

M-Shaped Segments



Enhance surface contact to aid cooling, reduce friction and improve acceleration into cuts

Cooling holes engineered to deliver smoother cuts

Laser welded segments for reliable performance throughout the life of the blade

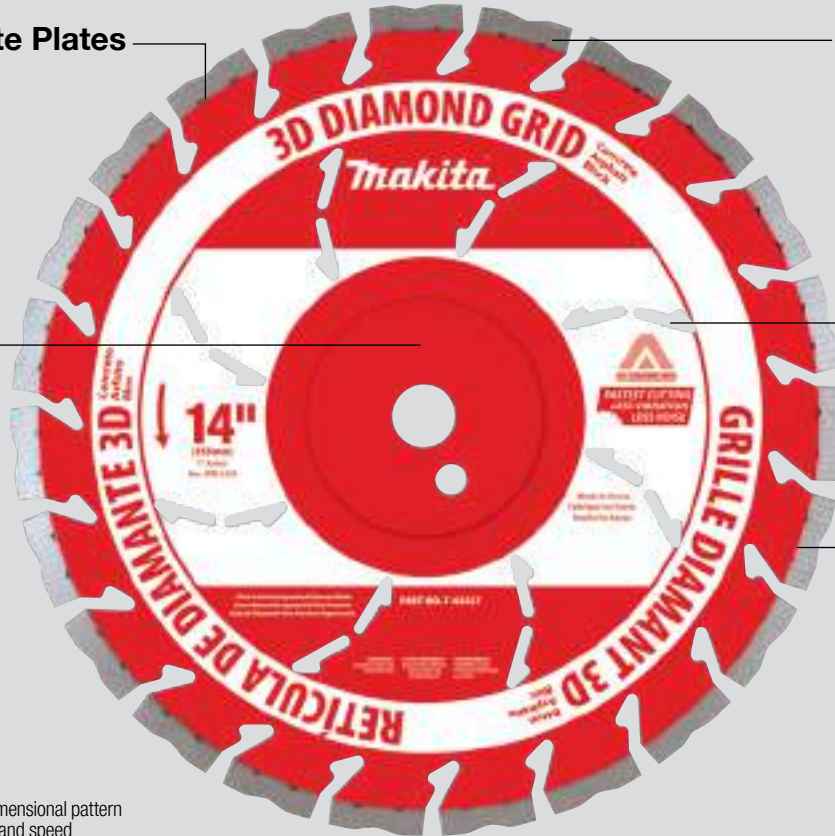

14" Diamond Blade (T-02537)

OPTIMUM PERFORMANCE Faster. Longer. Smoother.

Slots create significant cooling for segmented blades

Superior quality steel core

Laser welded to ensure the strongest joint possible

Highest quality diamonds

Optimum bond matrix provides a faster, longer, smoother diamond blade

FASTER
Cutting Speed

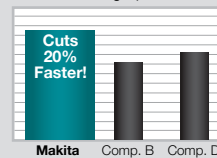

Concrete block using 4-1/2" grinder

LONGER
Number of Cuts

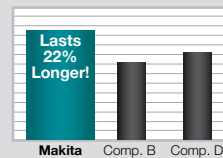

Granite using 4-1/2" grinder



Segmented Rim

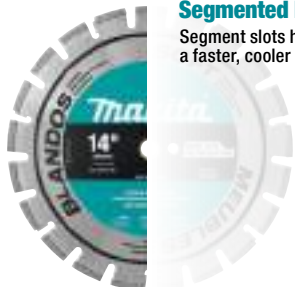

Segment slots help deliver a faster, cooler cut



Description	Diameter	Arbor	Material	Model	Part #
General Purpose – Cured Concrete, Block, Brick	10"	5/8"			T-01747
Dual Purpose – Cured Concrete, Block, Brick, Pavers	10"	5/8"			T-01258
General Purpose – Cured Concrete, Block, Brick	12"	1", 20mm			A-94720
Dual Purpose – Concrete, Asphalt	12"	1", 20mm		DPC6410, DPC7320	T-01264
Hard Materials – Granite, Ceramic, Fire Brick	14"	1", 20mm			A-94627
General Purpose – Cured Concrete, Block, Brick	14"	1", 20mm			A-94736
General Purpose – Cured Concrete, Block, Brick	14"	1", 20mm			A-94932*
Ultra-Premium – Cured Concrete, Green Concrete, Asphalt, Block, Brick, Granite	14"	1", 20mm		EK6101, EK7301, EK7651H	T-02537
Dual Purpose – Concrete, Asphalt	14"	1", 20mm			T-01270
Soft Materials – Asphalt, Green Concrete, Sand Stone	14"	1", 20mm			A-94655
Steel, Studs, Angle Iron, Channel, Steel Pipe	14"	1", 20mm			A-96229
General Purpose – Cured Concrete, Block, Brick	16"	1", 20mm			A-94742
Dual Purpose – Concrete, Asphalt	16"	1", 20mm		EK8100	T-01286
Soft Materials – Asphalt, Green Concrete, Sand Stone	16"	1", 20mm			A-94661

*Contractor Pack (3-Pack)

DIAMOND BLADES – SMALL DIAMETER

Description	Diameter	Arbor	Material	Model	Part #
 <p>Segmented Rim Segment slots help deliver a faster, cooler cut</p>	4"	7/8", 5/8", 20mm	General Purpose - Cured Concrete, Block, Brick	GA4030	A-94677
	4-1/2"	7/8", 5/8", 20mm	General Purpose - Cured Concrete, Block, Brick	9564CV/PC/P, XAG04, XAG11, XAG16, XAG17, XAG20, XAG21	A-94683 A-97623*
	5"	7/8", 5/8", 20mm	General Purpose - Cured Concrete, Block, Brick	9565CV/PC, XAG04, XAG11, XAG16, XAG17, XAG20, XAG21	A-94699
	6"	7/8", 5/8"	General Purpose - Cured Concrete, Block, Brick	9566CV/PC	A-94708
	7"	7/8", 5/8"	General Purpose - Cured Concrete, Block, Brick	GA7011C, GA7040S, XAG12	A-94714
 <p>Turbo Rim Constant contact with material delivers a smoother finish than segmented blades</p>	4"	7/8", 5/8", 20mm	Hard Materials - Granite, Ceramic, Fire Brick General Purpose - Cured Concrete, Block, Brick Hard Materials - Granite, Ceramic, Fire Brick	GA4030	A-94580 A-94546 A-94596
	4-1/2"	7/8", 5/8", 20mm	General Purpose - Cured Concrete, Block, Brick Soft Materials - Asphalt, Green Concrete, Sand Stone	9564CV/PC, XAG04, XAG11, XAG16, XAG17, XAG20, XAG21	A-94552 A-97617* A-94633
	5"	7/8", 5/8", 20mm	Hard Materials - Granite, Ceramic, Fire Brick General Purpose - Cured Concrete, Block, Brick	9565CV/PC, XAG04, XAG11, XAG16, XAG17, XAG20, XAG21	A-94605 A-94568
	7"	7/8", 5/8"	Hard Materials - Granite, Ceramic, Fire Brick General Purpose - Cured Concrete, Block, Brick Soft Materials - Asphalt, Green Concrete, Sand Stone	GA7011C, GA7040S, XAG12	A-94611 A-94574 A-94649
	9"	7/8", 5/8"	General Purpose - Cured Concrete, Block, Brick	XAG13, GA9040S, GA9060, GA9031Y	A-95847
	3-3/8"	15mm	General Purpose - Stone, Masonry General Purpose - Tile, Glass	CC01W, CC02R1	724950-8D 724950-8C
	4"	7/8", 5/8"	General Purpose - Tile, Porcelain, Stone	GA4030	A-95065
	5"	3/4"	Hard Materials - Granite, Ceramic, Fire Brick	4101RH	A-90934
	7"	7/8", 5/8"	General Purpose - Tile, Porcelain, Stone	GA7011C, GA7040S, XAG12	A-95087 *Contractor Pack (2-Pack)

DUAL SANDWICH TUCK POINT BLADES

Description	Diameter	Size	Arbor	Material	Model	Part #
 <p>Tuck Point Dual sandwich design for faster mortar removal and less dust</p>	4"					A-95906
	4-1/2"	1/4"	5/8", 20mm, 7/8"	General Purpose - Mortar Removal	9564CV/PC	A-95912
	5"				9565CV/PC	A-96017



↓

1/4" Thickness

↑



Guard available, see pg. 63

LOW VIBRATION DIAMOND CUP WHEELS

Description	Diameter	Rim	Segments	Arbor	Max. RPM	Model	Part #	
 <p>Low-Vibration Low-vibration design engineered to keep the wheel planted firmly on the surface for more efficient material removal</p>	4-1/2"	Double Row	10	5/8" - 11	13,400	9564CV/PC/P, 9565CV/PC, XAG04, XAG11, XAG16, XAG17, XAG20, XAG21	A-96198	
		Turbo	8			A-96403		
	5"	Turbo	30	5/8" - 11	12,500	9565CV/PC, XAG04, XAG11, XAG16, XAG17, XAG20, XAG21	A-98871	
		Single Row	12				A-96207	
		7"	Double Row	16	5/8" - 11	8,500	GA9040S, XAG12	A-96213
			Turbo	12				A-96419
			24			A-96425		



A-96403 shown on 9564CV (not included)

Shroud available, see pg. 63

4" ANGLE GRINDER ACCESSORY GUIDE

Part ID	Grinding Wheel	Flex Wheel	Cut-Off Wheel	Resin Fiber Disc	Diamond Blade	Wire Wheel	Wire Brush	Multi-Disc
A Wheel Guards Page 128								
B Inner Flanges & Backing Pads Pages 128 & 131								
C Abrasives Pages 129-133								
D Lock Nuts Page 128								

4-1/2" – 9" ANGLE GRINDER ACCESSORY GUIDE

Part ID	Grinding Wheel	Hubbed Grinding Wheel	Resin Fiber Disc	Wire Wheel	Wire Brush	Diamond Blade	Tuck Point	Multi-Disc	Hubbed Multi-Disc	Cut-off Wheel
A Wheel Guards Page 128										
B Inner Flanges & Backing Pads Pages 128 & 131										
C Abrasives Pages 129-133										
D Lock Nuts Page 128										

A WHEEL GUARDS

Description	Grinder Size	Model	Part #
Wheel Guard	4"	GA4030	125885-4
	4"	GA4030, 9553NB	135475-5
For all grinding operations except for cut-off wheels	4-1/2"	9557NB/PB, BGA452, XAG01, XAG04	125890-1
	4-1/2"	9564CV/PC/P	165053-7
	4-1/2"	GA4530, GA4534	122886-3
	4-1/2"	XAG03, XAG06, XAG04, XAG11	123144-0
	4-1/2" (tool-less)	9564CV/PC/P	135107-4
	5"	9005B/BZ	135040-0
	5"	GA5020, 9015A	125097-9
	5"	9558PB	125274-3
	5"	9005B/BZ	135549-2
	5" (tool-less)	9565CV/PC, GA5010Z, GA5020/Y	135650-3
	6"	9016B	134961-3
	6" (tall / tool-less)	GA6010Z, GA6020, 9566CV/PC	135172-3
	6" (short / tool-less)	GA6010Z, GA6020, 9566CV/PC	135110-5
	7"	GA7001L	164477-4
	7"	GA7911	191214-3
	7" (tool-less)	GA7020, GA7021, GA7040S	122767-1
	7" (tool-less)	GA7011C	122772-8
	9"	GA7911, GA9020, GA9040S, GA7060	191215-1
	9" (tool-less)	GA9020, GA9040S, GA9060	122768-9

Description	Grinder Size	Model	Part #
Wheel Guard	4-1/2" - 5"	Makita 4-1/2"-5" Grinders Except 9005B	195236-5
For dust collecting, surfacing	7"-9"	Makita 7" & 9" Grinders Except GA7911, GA7001L	195386-6*

*Accepts wheels up to 7" in diameter

CUT-OFF WHEEL GUARD

Description	Grinder Size	Model	Part #
Cut-Off Wheel Guard	4-1/2"	BGA452, 9564CV/PC/P, GA4030, XAG01, XAG04	135103-2
For cut-off wheel applications	4-1/2"	GA4530, GA4534, XAG03, XAG04, XAG06, XAG11	122910-2
	5"	9005B/BZ	122688-7
	5"	9558PB, 9565CV/PC, GA5010Z, GA5020/Y	122641-3
	6"	GA6010Z, GA6020, 9566CV/PC	165744-0

Description	Grinder Size	Model	Part
Wheel Guard		9564CV/PC/P, 9565CV/PC	193794-5 (with shoe)
For dust collecting, cutting	4-1/2" - 5"	9564CV/PC/P, 9565CV/PC	192618-2
		9565CV/PC	196846-1
		GA4542C, GA5042C	196845-3

Description	Grinder Size	Model	Part #
Cutting Guard	9"	GA9040S, GA9031Y, GA9060, XAG13, XAG23	198509-5

B INNER FLANGES

Description	Grinder Size	Model	Part #
Inner Flange	4"	GA4030	224377-1
	4"	N9501BZ	224376-3
	4-1/2", 5", 6"	9557NB/PB, 9564CV/PC/P, 9558PB, 9565PC, GA5010Z, GA5020, GA4534, XAG01, XAG03, XAG04, XAG06, XAG11	224399-1
	4-1/2", 5", 6", 7"	9005B/BZ, 9564CV/PC/P, 9565CV, GA7011C	224378-9
	5", 6" (for use with cut-off wheels)	9005B/BZ, 9527NB, GA6010Z	224361-6
	6"	9566CV/PC	224390-9
	7"	GA7001L, GA7911	224111-9
	7", 9"	9077SL, GA7020, GA7021, GA7040S, GA7060, GA9020, GA9040S, GA9060	224317-9

D LOCK NUTS

Description	Grinder Size	Model	Part #
Lock Nuts	4"	GA4030	194608-1

For use with flex wheels

Lock Nuts For use with diamond blade, grinding, cut-off*, and multi-disc wheels

4"	GA4030	194608-1
4-1/2", 5", 7", 9"	9005B/BZ, 9557NB/PB, 9558PB, 9564CV/PC, 9565CV/PC, GA5010Z, GA5020, GA6020, GA7011C, GA7020, GA7021, GA7031Y, GA7040S, GA7060, GA9020, GA9040S, GA9031Y, GA9060, XAG01, XAG03, XAG04, XAG06, XAG11	193465-4
6"	9566CV/PC, GA6010Z, GA6020	224574-9
7"	GA7001L, GA7911	224512-1

*Use with corresponding cut-off wheel guard & lock nut

Lock Nut

4"	GA4030	224501-6
4-1/2"-9"	9557NB/PB, 9564CV/PC/P, GA4530, GA4534, 9005B/BZ, 9565CV/PC, GA5010Z, GA5020/Y, 9566CV/PC, GA6010, GA6020, GA6060, GA7001L, GA7911, GV7000C, 9227C, 9227CY, GA7011C, GA7020, GA7021, GA7060, XAG01, XAG03, XAG04, XAG06, XAG11	193048-0

INOX GRINDING WHEELS

FASTER MATERIAL REMOVAL Less Noise. Less Vibration. Improved Efficiency.

- Aggressive composition for faster material removal
- Innovative design for reduced noise
- Reduced vibration for superior user experience
- "N" grade hardness is ideal for working with stainless steel



EFFICIENCY
Reduced vibration for superior user experience

Stainless Steel Depressed Center Wheels



Diameter	Thickness	Arbor	Grit	Max. RPM	Model	1/Pkg. Part #	5/Pkg. Part #	10/Pkg. Part #	25/Pkg. Part #
4"	1/4", .250"	7/8"	36	15,300	GA4030/K	-	-	-	A-96039-25
4-1/2"	1/4", .250"	7/8"	36	13,300	9557NB/PB, 9564CV/PC/P, GA4530, GA4534, XAG01, XAG03, XAG04, XAG06, XAG11, XAG16, XAG17, XAG20, XAG21	A-95956	A-95956-5	-	A-95956-25
5"	1/4", .250"	7/8"	36	12,250	9005B/BZ, 9558PB, 9565CV/PC, GA5010Z, GA5020/Y, XAG04, XAG11, XAG16, XAG17, XAG20, XAG21	A-95962	A-95962-5	-	A-95962-25
6"	1/4", .250"	7/8"	36	10,200	9566CV/PC, GA6010Z, GA6020	A-95978	A-95978-5	-	A-95978-25
7"	1/4", .250"	7/8"	36	8,500	GA7001L, GA7011C, GA7020, GA7021, GA7031Y, GA7040S, GA7060, XAG12	A-96045	-	A-96045-10	-
9"	1/4", .250"	7/8"	36	6,650	GA9020, GA9031Y, GA9040S, GA9060, XAG13	A-96051	-	A-96051-10	-

Hubbed Stainless Steel Depressed Center Wheels



Diameter	Thickness	Arbor	Grit	Max. RPM	Model	1/Pkg. Part #	5/Pkg. Part #	10/Pkg. Part #	25/Pkg. Part #
4-1/2"	1/4", .250"	5/8"-11	36	13,300	9557NB/PB, 9564CV/PC/P, GA4530, GA4534, XAG01, XAG03, XAG04, XAG06, XAG11, XAG16, XAG17, XAG20, XAG21	A-95984	A-95984-5	-	A-95984-25
5"	1/4", .250"	5/8"-11	36	12,250	9005B/BZ, 9558PB, 9565CV/PC, GA5010Z, GA5020/Y, XAG04, XAG11, XAG16, XAG17, XAG20, XAG21	A-95990	A-95990-5	-	A-95990-25
6"	1/4", .250"	5/8"-11	36	10,200	9566CV/PC, GA6010Z, GA6020	A-96001	A-96001-5	-	A-96001-25

C GRINDING WHEELS

General Purpose Metal Depressed Center Wheels



- Aluminum oxide abrasive grains are evenly distributed to give a smooth surface
- Innovative grain structure engineered for optimum performance, efficient material removal and longer wheel life
- Ideal for grinding ferrous metals, metal, polishing and general flat grinding

Diameter	Thickness	Arbor	Grit	Max. RPM	Model	1/Pkg. Part #	5/Pkg. Part #	10/Pkg. Part #	25/Pkg. Part #
4"	3/16", .188"	5/8"	24	13,690		741402-8-1	741402-8	-	741402-B-25
4"	1/4", .250"	5/8"	24	13,700	GA4030	741402-9-1	741402-9AP	-	741402-C-25
4"	3/16", .188"	5/8"	36	13,690		741405-2-1	741405-2P	-	-
4-1/2"	1/4", .250"	7/8"	24	11,900	9557NB/PB, 9564CV/PC/P, GA4530, GA4534, XAG01, XAG03, XAG04, XAG06, XAG11, XAG16, XAG17, XAG20, XAG21	741423-0-1	741423-0	-	741423-B-25
4-1/2"	1/4", .250"	7/8"	36	11,900		741424-8-1	741424-8	-	-
5"	1/4", .250"	7/8"	24	11,000	9558PB, 9565CV/PC, GA5010Z, GA5010Z, GA5020/Y, XAG04, XAG11, XAG16, XAG17, XAG20, XAG21	741407-8-1	-	-	741407-B-25
7"	1/4", .250"	7/8"	24	8,500	GA7001L, GA7011C, GA7020, GA7021, GA7031Y, GA7040S, GA7060, XAG12	741413-3	-	741413-B-10	-
9"	1/4", .250"	7/8"	24	6,600	GA9020, GA9031Y, GA9040S, GA9060, XAG13	-	-	741421-B-10	-

Hubbed General Purpose Metal Wheels



- Aluminum oxide abrasive grains are evenly distributed to give a smooth surface
- Innovative grain structure engineered for optimum performance, efficient material removal and longer wheel life

Diameter	Thickness	Arbor	Grit	Max. RPM	Model	1/Pkg. Part #	5/Pkg. Part #	10/Pkg. Part #	25/Pkg. Part #
4-1/2"	1/4", .250"	5/8" - 11	24	11,900	9557NB/PB, 9564CV/PC/P, GA4530, GA4534, XAG01, XAG03, XAG04, XAG06, XAG11, XAG16, XAG17, XAG20, XAG21	-	-	741416-B-10	-
5"	1/4", .250"	5/8" - 11	24	11,000	9005B/BZ, 9558PB, 9565CV/PC, GA5010Z, GA5020/Y, XAG04, XAG11, XAG16, XAG17, XAG20, XAG21	-	-	741417-B-10	-
7"	1/4", .250"	5/8" - 11	24	8,500	GA7001L, GA7011C, GA7020, GA7021, GA7031Y, GA7040S, GA7060, XAG12	-	-	741414-B-10	-
9"	1/4", .250"	5/8" - 11	24	6,600	GA9020, GA9031Y, GA9040S, GA9060, XAG13	-	-	741415-B-10	-

Masonry Depressed Center Wheels



- Constructed with silicon carbide grade C24
- For surfacing and grinding masonry

Diameter	Thickness	Arbor	Grit	Max. RPM	Model	1/Pkg. Part #	5/Pkg. Part #	10/Pkg. Part #	25/Pkg. Part #
4-1/2"	1/4", .250"	7/8"	24	11,900	9557NB, PB, 9564CV/PC/P, GA4530, GA4534, XAG01, XAG03, XAG04, XAG06, XAG11, XAG16, XAG17, XAG20, XAG21	-	-	-	741426-B-25
5"	1/4", .250"	7/8"	24	12,250	9005B/BZ, 9558PB, 9565CV/PC, GA5010Z, GA5020/Y, XAG16, XAG17, XAG20, XAG21	-	-	-	741427-B-25
7"	1/4", .250"	5/8"	24	8,500	GA7001L, GA7011C, GA7020, GA7021, GA7031Y, GA7040S, GA7060, XAG12	-	-	741428-B-10	-

Warning: Consult owner/operator manual and adhere to all safety precautions for accessory items. Always use recommended guards. Failure to do so may result in serious injury or death from exploding wheels. Refer to ANSI B7.1 and owner/operator manual for proper accessory mounting and grinding procedures. Always wear eye protection that meets ANSI Z87.1 requirements plus a face shield wherever possible. Tools must always be properly guarded.

FASTER CUTTING
20% Thinner than Most Competitor Wheels

Zirconia Aluminum construction makes these wheels ideal for ferrous metals including stainless steel



60 grit abrasive for cleaner cuts

Ultra-thin design requires less energy for improved battery life when used with cordless grinders

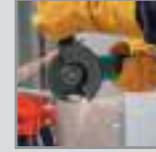

FASTER CUTTING
.032" thick wheel is 20% thinner than most competitor wheels

INOX Ultra Thin Cut-Off Wheels	Diameter	Thickness	Arbor	Grit	Max. RPM	Model	1/Pkg. Part #	25/Pkg. Part #
---------------------------------------	-----------------	------------------	--------------	-------------	-----------------	--------------	----------------------	-----------------------

Fiat Center

- .032" thick for faster cutting and reduced material waste



4"	.032"	5/8"	60	15,300		GA4030	B-46143	B-46143-25
4-1/2"	.032"	7/8"	60	13,300	9557NB/PB, 9564CV/PC/P, GA4530, GA4534, XAG01, XAG03, XAG04, XAG06, XAG11, XAG16, XAG17, XAG20, XAG21		B-46159	B-46159-25
5"	.032"	7/8"	60	12,250	9005B/BZ, 9558PB, 9565CV/PC, GA5010Z, GA5020/Y, XAG04, XAG11, XAG16, XAG17, XAG20, XAG21		B-46165	B-46165-25

Depressed Center

- For making cuts in metal and stainless steel pipes, sheet, and channel



4-1/2"	.032"	7/8"	60	13,300	9557NB/PB, 9564CV/PC/P, GA4530, GA4534, XAG01, XAG03, XAG04, XAG06, XAG11, XAG16, XAG17, XAG20, XAG21		A-96431	A-96431-25
5"	.032"	7/8"	60	12,250	9005B/BZ, 9558PB, 9565CV/PC, GA5010Z, GA5020/Y, XAG04, XAG11, XAG16, XAG17, XAG20, XAG21		A-96447	A-96447-25

INOX Thin Cut-Off Wheels	Diameter	Thickness	Arbor	Grit	Max. RPM	Model	Metal 1/Pkg. Part #	Metal 10/Pkg. Part #
---------------------------------	-----------------	------------------	--------------	-------------	-----------------	--------------	----------------------------	-----------------------------



- Aluminum Oxide construction makes these wheels ideal for ferrous metals including stainless steel

4"	.040"	5/8"	60	15,300		GA4030	-	B-12625-10
4-1/2"	.040"	7/8"	60	13,300	9557NB/PB, 9564CV/PC/P, GA4530, GA4534, XAG01, XAG03, XAG04, XAG06, XAG11, XAG16, XAG17, XAG20, XAG21		-	B-12631-10
5"	.040"	7/8"	60	12,250	9005B/BZ, 9558PB, 9565CV/PC, GA5010Z, GA5020/Y, XAG04, XAG11, XAG16, XAG17, XAG20, XAG21		-	B-12647-10
6"	1/16" / .060"	7/8"	60	10,200	9566CV/PC, GA6010Z, GA6020		-	B-12653-10
7"	1/16" / .060"	7/8"	60	8,500	GA7001L, GA7011C, GA7020, GA7021, GA7031Y, GA7040S, GA7060, XAG12		B-12669	B-12669-10
9"	5/64" / .075"	7/8"	60	6,650	GA7001L, GA7011C, GA7020, GA7021, GA7031Y, GA7040S, GA7060, XAG12		B-12675	B-12675-10

Super Thin Cut-Off Wheels	Diameter	Thickness	Arbor	Grit	Max. RPM	Model	Metal 25/Pkg. Part #
----------------------------------	-----------------	------------------	--------------	-------------	-----------------	--------------	-----------------------------



- Super thin design lasts up to 3.5x longer than standard cut-off wheels

4"	3/64" / .045"	5/8"	46	15,280		GA4030	724114-A-25
4-1/2"	3/64" / .045"	7/8"	46	13,285	9557NB/PB, 9564CV/PC/P, GA4530, GA4534, XAG01, XAG03, XAG04, XAG06, XAG11, XAG16, XAG17, XAG20, XAG21		724115-A-25
5"	3/64" / .045"	7/8"	46	12,200	9005B/BZ, 9558PB, 9565CV/PC, GA5010Z, GA5020/Y, XAG04, XAG11, XAG16, XAG17, XAG20, XAG21		724116-A-25
6"	1/16" / .060"	7/8"	46	10,185	9566CV/PC, GA6010Z, GA6020		724117-A-25

Cut-Off Wheels	Diameter	Thickness	Arbor	Grit	Max. RPM	Model	Metal 1/Pkg. Part #	Metal 25/Pkg. Part #	Masonry 10/Pkg. Part #
-----------------------	-----------------	------------------	--------------	-------------	-----------------	--------------	----------------------------	-----------------------------	-------------------------------



- For all ferrous materials, steel, and cast iron
- For masonry/concrete, marble, slate, and more

4"	3/32" / .100"	5/8"	30	15,300			A-98245	-	-
4"	5/64" / .080"	5/8"	46	15,300		GA4030	A-98815	A-98815-25	-
4"	3/32" / .090"	5/8"	36	15,270			-	-	724104-1-10





Flex Wheels	Diameter	Thickness	Arbor	Grit	Max. RPM	Model	10/Pkg. Part #	25/Pkg. Part #
--------------------	-----------------	------------------	--------------	-------------	-----------------	--------------	-----------------------	-----------------------













- Improved material removal with less noise and vibration for improved efficiency

4"	1/8"	5/8"	46	13,690		GA4030	741404-OBP	-
4"	1/8"	5/8"	60	13,690			741404-0CP	-
4-1/2"	5/32"	7/8"	36	13,300	9557NB/PB, 9564CV/PC/P, GA4530, GA4534, XAG01, XAG03, XAG04, XAG06, XAG11, XAG16, XAG17, XAG20, XAG21		-	A-97411-25 (Stainless - INOX)



SANDING / POLISHING PADS & BONNETS

B	Description	Grinder/Polisher Size	Model	Part #	C	Description	Grinder/Polisher Size	Model	Part #		
	Rubber Pad	4"	GA4030/K	743009-6		5-1/2" Hook-and-Loop Foam Pad Polishing / White	5-1/2"	B06050J, B06030	T-02668		
			PW5001C	743079-5		5-1/2" Hook-and-Loop Foam Pad Polishing / Orange			T-02674		
		4-1/2"	9557NB/PB, 9564CV/P/PC, GA4530, GA4534, XAG01, XAG03, XAG04, XAG06, XAG11, XAG16, XAG17, XAG20, XAG21	743036-3		5-1/2" Hook-and-Loop Foam Pad Polishing / Black			T-02680		
		5"	9005B/BZ, 9015A, 9565CV/PC, GA5010Z, GA5020/Y, XAG16, XAG17, XAG20, XAG21	743015-1		6" Round Hook and Loop Wool Polishing Pad Polishing / Compounding			6"	B06050J, B06030	199424-6
		6"	9566CV/PC, GA6010, GA6020	743016-9		7" Wool Bonnet Tie Back					794176-0
	Plastic Pad	5"	GV5000, GV5010, GA5010Z	743025-8		7" Hook-and-Loop Pad Compounding	7"	9227C/CY, 9237C, PV7001C	192629-7		
		Hook-and-Loop Backing Pad	6"	B06050J		197315-5			7" Hook-and-Loop Pad Polishing	743403-A	
			7"	9227C/CY, 9237C, PV7001C		743052-5			7" Hook-and-Loop Foam Pad Polishing	9227C, 9227CY, PV7001C	193470-1
	Pressure Sensitive Pad (PSA)	5"	B05030, B05030K, B05031K, B05041K	743082-6							

WIRE BRUSHES

Description	Diameter	Arbor	Max. RPM	Carbon Steel Part #	Stainless Steel Part #
 <ul style="list-style-type: none"> Durable carbon steel wire construction Removes rust, scale and weld splatter For angle grinders 	3"	M10 x 1.25	13,500	A-98382	-
	3"	5/8" - 11	12,500	A-98398	-
	4"	5/8" - 11	8,500	A-98407	-
	6"	5/8" - 11	6,600	A-98413	-
 <ul style="list-style-type: none"> Removes rust, scale and weld splatter For angle grinders 	4"	5/8" - 11	12,500	A-98376	-
	 <ul style="list-style-type: none"> Ideal for deburring, edge blending and finishing For angle grinders 	4"	M10 x 1.25	13,500	A-98653
4"		5/8"-11	12,500	A-98669	-
 <ul style="list-style-type: none"> Ideal for grooves, curves, and corners For angle grinders 	3-3/8"	M10 x 1.25	13,500	A-98631	-
	3-3/8"	5/8"-11	12,500	A-98647	-
 <ul style="list-style-type: none"> Narrow design for hard to reach areas 	1"	1/4"	4,500	B-63030	-
 <ul style="list-style-type: none"> Narrow design for hard to reach areas 	1/4"	1/4"	4,500	B-63052	-
 <ul style="list-style-type: none"> Removes rust, scale and weld splatter 	3"	1/4"	4,500	B-63074	-
 <ul style="list-style-type: none"> Removes rust, scale and weld splatter 	3"	1/4"	4,500	B-63080	-
 <ul style="list-style-type: none"> Rugged knot construction Ideal for tight operations, corners, and angle welds For use with angle grinders 	2-3/4"	5/8"-11	12,500	A-98429	-
	2-3/4"	5/8"-11	12,500	-	A-98435
	2-3/4"	M10 x 1.25	13,500	A-98441	-
	2-3/4"	M10 x 1.25	13,500	-	A-98457
	4"	5/8"-11	8,500	A-98463	-
6"	5/8"-11	6,600	A-98479	-	
 <ul style="list-style-type: none"> Allows cup or wheel with 5/8"-11 arbors to fit M10 x 1.25 arbors 				Part #	A-98619

WIRE WHEELS

Description	Diameter	Arbor	Max. RPM	Carbon Steel Part #	Stainless Steel Part #
 <ul style="list-style-type: none"> 3/16" face for hard to reach places For surface preparation on welds, piping and pipe grooves For use with angle grinders 	4"	5/8"-11	12,500	A-98485	-
	4"	5/8"-11	12,500	-	A-98491
	4"	M10 x 1.25	13,500	A-98500	-
	4"	M10 x 1.25	13,500	-	A-98516
	5"	5/8"-11	12,500	A-98522	-
	6"	5/8"-11	8,500	A-98538	-
 <ul style="list-style-type: none"> 1/4" face for narrow to medium width work Ideal for cleaning welds For use with angle grinders 	4"	M10 x 1.25	13,500	A-98550	-
	4"	5/8"-11	12,500	A-98572	-
	4"	5/8"-11	12,500	-	A-98588
	5"	5/8"-11	12,500	A-98594	-
6"	5/8"-11	8,500	A-98603	-	

Warning: Consult owner/operator manual and adhere to all safety precautions for accessory items. Always use recommended guards. Failure to do so may result in serious injury or death from exploding wheels. Refer to ANSI B7.1 and owner/operator manual for proper accessory mounting and grinding procedures. Always wear eye protection that meets ANSI Z87.1 requirements plus a face shield wherever possible. Tools must always be properly guarded.

C

MULTI-DISCS

Angled Design (Type 29)



- For metal, wood, and plastic

Zirconium abrasive grain provides consistent high cut rate, runs cooler and lasts longer than aluminum oxide



Phenolic backing prevents backing from scratching work surface

Angled design for increased contact area

General Purpose Depressed Center Wheels (Angled Type 29)



LASTS 20X LONGER THAN RESIN FIBER DISCS

- Ensures 90% of the abrasive material is in contact with the work surface, providing superior cut rate and maximum disc life.
- For weld head blending, removing weld slag, deburring, edge blending, surface conditioning, and metal fabrication
- Works at 10° to 25° angle

Diameter	Arbor	Grit	Max. RPM	Model	Carded Part #	10/Pkg. Part #
4"	5/8"	36	11,200	GA4030	741840-A	741810-B-10
4"	5/8"	60	11,200		741841-A	741811-B-10
4"	5/8"	80	11,200		741842-A	741812-B-10
4"	5/8"	120	11,200		741843-A	741813-B-10
4-1/2"	7/8"	36	11,000	9557NB/PB, 9564CV/PC/P, GA4530, GA4534, XAG01, XAG03, XAG04, XAG06, XAG11, XAG16, XAG17, XAG20, XAG21	741844-A	741814-B-10
4-1/2"	7/8"	60	11,000		741845-A	741815-B-10
4-1/2"	7/8"	80	11,000		741846-A	741816-B-10
4-1/2"	7/8"	120	11,000		741847-A	741817-B-10
5"	7/8"	36	10,400	9558PB, 9565CV/PC, GA5010Z, GA5020/Y, XAG04, XAG11, XAG16, XAG17, XAG20, XAG21	-	741818-B-10
5"	7/8"	60	10,400		-	741819-B-10
5"	7/8"	80	10,400		-	741820-B-10
5"	7/8"	120	10,400		-	741821-B-10
7"	7/8"	60	6,600	GA7001L, GA7011C, GA7020, GA7021, GA7031Y, GA7040S, GA7060, XAG12	-	741823-B-10
7"	7/8"	80	6,600		-	741824-B-10

General Purpose Hubbed Wheels (Angled Type 29)



- For metal, wood, and plastic
- Works at 10° to 25° angle

Diameter	Arbor	Grit	Max. RPM	Model	Carded Part #	10/Pkg. Part #
4-1/2"	5/8" - 11	36	11,000	9557NB/PB, 9564CV/PC/P, GA4530, GA4534, XAG01, XAG03, XAG06, XAG04, XAG11, XAG16, XAG17, XAG20, XAG21	-	741832-B-10
4-1/2"	5/8" - 11	60	11,000		-	741833-B-10
4-1/2"	5/8" - 11	80	11,000		-	741834-B-10
4-1/2"	5/8" - 11	120	11,000		-	741835-B-10
7"	5/8" - 11	36	6,600	GA7001L, GA7011C, GA7020, GA7021, GA7031Y, GA7040S, XAG12	-	741836-B-10
7"	7/8"	36	6,600		-	741822-B-10
7"	5/8" - 11	80	6,600		-	741838-B-10

Flat Design (Type 27)



- For metal, wood, and plastic
- Conforms to flat or irregular surfaces
- Excellent finish consistency at a working angle of 0° to 15°

Zirconium abrasive grain provides consistent high cut rate, runs cooler and lasts longer than aluminum oxide



Phenolic backing prevents backing from scratching work surface

Flat design great for use on joints, corners and edges

General Purpose Depressed Center Wheels (High Density Flat Type 27)



LASTS 30X LONGER THAN RESIN FIBER DISCS

Diameter	Arbor	Grit	Max. RPM	Model	Carded Part #	10/Pkg. Part #
4-1/2"	7/8"	40	11,000	9557NB/PB, 9564CV/PC/P, GA4530, GA4534, XAG01, XAG03, XAG04, XAG06, XAG11, XAG16, XAG17, XAG20, XAG21	-	741826-B-10
4-1/2"	7/8"	60	11,000		-	741827-B-10
4-1/2"	7/8"	80	11,000		-	741828-B-10
7"	7/8"	60	6,600		-	741830-B-10
7"	7/8"	80	6,600	GA7001L, GA7011C, GA7020, GA7021, GA7031Y, GA7040S, GA7060	-	741831-B-10

Masonry Depressed Center Wheels (Flat Type 27)



- For brick, stone and concrete

Diameter	Arbor	Grit	Max. RPM	Model	Carded Part #	10/Pkg. Part #
4"	5/8"	24	13,000	GA4030	A-90130	-
4-1/2"	7/8"	24	12,000	9557NB/PB, 9564CV/PC/P, GA4530, GA4534, XAG01, XAG03, XAG04, XAG06, XAG11, XAG16, XAG17, XAG20, XAG21	A-90249	-

STRAIGHT GRINDER WHEELS

FASTER MATERIAL REMOVAL Aggressive. Versatile. Heavy-Duty.



DURABILITY
Built for faster material removal and long life in demanding applications

Aluminum oxide abrasive for use in a variety of metals

Aggressive grit for efficient material removal



Straight Grinder Wheels	Diameter	Arbor	Grit	Thickness	Model	Part #
-------------------------	----------	-------	------	-----------	-------	--------



	5"	13/16"	24	13/16"	GS5000	B-28852
	5"	13/16"	36	13/16"	GS5000	B-28868

C RESIN FIBER DISCS

Resin Fiber Discs	Diameter	Arbor	Grit	Max. RPM	Model	5/Pkg. Part #	25/Pkg. Part #
-------------------	----------	-------	------	----------	-------	---------------	----------------



- Superior stock removal for increased efficiency
- Specially formulated resin bond coat for increased durability and efficiency
- Ideal for use on metal and wood
- Applications include blending, deburring, finishing and grinding
- Use with corresponding rubber pad and lock nut

	4"	5/8"	24	15,000	GA4030	742036-A-5	742036-B-25
	4"	5/8"	36	15,000		742037-A-5	742037-B-25
	4"	5/8"	50	15,000		742038-A-5	742038-B-25
	4"	5/8"	80	15,000		742039-A-5	742039-B-25
	4"	5/8"	100	15,000		742087-A-5	742087-B-25
	4"	5/8"	120	15,000		742040-A-5	742040-B-25
	4-1/2"	7/8"	24	13,000	9557NB/PB, 9564CV/PC/P, GA4530, GA4534, XAG01, XAG03, XAG04, XAG06, XAG11, XAG16, XAG17, XAG20, XAG21	794104-A-5	794104-B-25
	4-1/2"	7/8"	36	13,000		794105-A-5	794105-B-25
	4-1/2"	7/8"	50	13,000		794106-A-5	794106-B-25
	4-1/2"	7/8"	80	13,000		794107-A-5	794107-B-25
	4-1/2"	7/8"	120	13,000		794108-A-5	794108-B-25
	5"	1/2"	24	11,900	GV5010	742106-A	742106-B-25
	5"	1/2"	36	11,900		742107-A	742107-B-25
	5"	1/2"	50	11,900		742108-1	742108-B-25
	5"	1/2"	80	11,900		742109-9	742109-B-25
	5"	1/2"	120	11,900		742110-4	742110-B-25
	5"	7/8"	24	11,900	9558PB, 9565CV/PC, GA5010Z, GA5020Y, XAG04, XAG11, XAG16, XAG17, XAG20, XAG21	742072-A-5	742072-B-25
	5"	7/8"	36	11,900		742073-A-5	742073-B-25
	5"	7/8"	50	11,900		742074-A-5	742074-B-25
	5"	7/8"	80	11,900		742075-A-5	742075-B-25
	5"	7/8"	120	11,900		742076-A-5	742076-B-25
	7"	7/8"	16	8,550	GA7001L, GA7011C, GA7020, GA7021, GA7031Y, GA7040S, GA7060, XAG12	742067-A-5	742067-B-25
	7"	7/8"	24	8,550		742069-A-5	742069-B-25
	7"	7/8"	36	8,550		742089-A-5	742089-B-25
	7"	7/8"	50	8,550		742070-A-5	742070-B-25
	7"	7/8"	80	8,550		742071-A-5	742071-B-25
	7"	7/8"	120	8,550		742091-A-5	742091-B-25

DIE GRINDER ACCESSORIES

Collet Cone

- For securing wheels and points



Diameter	Model	Part #
1/8"	906H,	763626-6
1/4"	GD0600, XDG01	763625-8
1/8"	GD0800C,	192987-1
1/4"	GD0801C	192986-3
1/8"	LXDG01	763672-9
1/4"		763673-7

Wheel Point

- For hardened steel



Diameter	Model	Part #
1/4"	GD0600, GD0601, GD0800C, GD0810C, GD080K, XDG01T, GD0801C	741616-9
1/4"		741617-7

Vise Holder Set



Model	Part #
GD0800C	193141-0

Warning: Consult owner/operator manual and adhere to all safety precautions for accessory items. Always use recommended guards. Failure to do so may result in serious injury or death from exploding wheels. Refer to ANSI B7.1 and owner/operator manual for proper accessory mounting and grinding procedures. Always wear eye protection that meets ANSI Z87.1 requirements plus a face shield wherever possible. Tools must always be properly guarded.

ABRASIVE CUTTING WHEELS

Up to 30% more cuts per charge when compared to 7/64" thick abrasive wheels

Ultra-thin design is ideal for use with Cordless Cut-Off Saws

Extra long life when cutting lighter gauge metals when used with Cordless Cut-Off Saws

B-64705



Description	Diameter	Arbor	Material	Qty./Pkg.	Model	Part #
Power Cutter Abrasive Cut-Off Wheels	12"	1"	Concrete, Stone, Masonry and Asphalt	10	4112H, DPC6410, DPC7320	965-210-611
		1"	Ferrous Metals	10		965-210-621
	14"	1"	Concrete, Stone, Masonry and Asphalt	10	4114, EK7651H, EK7301, EK6101	965-210-222
		1"	Ferrous Metals	10		965-210-212
Chop Saw Abrasive Cut-Off Wheels	12"	20mm	Concrete, Stone, Masonry and Asphalt	1	EK8100	966-161-020
		1"	Steel, Studs, Angle Iron, Channel and Steel Pipe	5		2412N
	1"		Steel, Studs, Angle Iron, Channel and Steel Pipe	5	2414NB, 2414DB, LW1400, LW1401	
		1"	Steel, Studs, Angle Iron, Channel and Steel Pipe	25		A-93859-25
	14"		1"	Steel, Studs, Angle Iron, Channel and Steel Pipe	5	2414NB, 2414DB, LW1400, LW1401
		Steel, Studs, Angle Iron, Channel and Steel Pipe		25	B-10849-25	
		1"	Angle Iron, Steel Pipe	5	2414NB, 2414DB, LW1400, LW1401, XWL01	B-57598-5
			Angle Iron, Steel Pipe	25		B-57598-25
	16"	1"	Studs	5	2416S	B-64705-5
			Studs	25		B-64705-25

METAL CUTTING DIAMOND BLADES

Description	Diameter	Arbor	Material	Qty./Pkg.	Model	Part #
Metal Cutting Diamond Blade for Power Cutters	14"	1"	Steel, Studs, Angle Iron, Channel, Steel Pipe	1	EK7651H, EK7301, EK6101	A-96229

NIBBLER & SHEAR ACCESSORIES

Shear Blades



Description	Model	Part #
Right Blade		725092-5
Center Blade	JS1300, XSJ01T	725094-1
Left Blade		725093-3
Left & Right Blade Set	JS1670	792536-0
Center Blade		792537-8
Blade Set	JS1600, JS1602	191383-0
Blade Set	JS3201	792287-5
Side Blade Set		725130-3
Center Blade Set	JS8000	725129-8
Shear Blade Kit		135168-4
Side Blade Set	JS1600, JS1602	792533-6
Center Blade Set		792534-4

Punch



Model	Part #
JN1600	792265-5
JN1601, XNJ01	A-83951
JN3200, JN3201	792728-1

Die



Model	Part #
JN1600	792264-7
JN1601, XNJ01	A-15051
JN3200, JN3201	792292-2

COMPACT BAND SAW ACCESSORIES

Bi-Metal Band Saw Blades 32-7/8" x 1/2" x 0.020"

Workpiece Thickness	TPI	1/Pkg. Part #	5/Pkg. Part #
1/4" - 1/2"	14	-	B-40543
1/8" - 1/4"	18	A-97570	

- Improved welding process for longer life
- Durable bi-metal construction

- Designed to cut non-ferrous metal, mild steel, cast steel, cast iron and stainless steel



Workpiece Thickness	TPI	1/Pkg. Part #
1/2" +	10	792557-B
1/4" - 1/2"	14	792557-A
1/8" - 1/4"	18	792556-A
- 1/8"	24	792555-A

44-7/8" x 1/2" x .020"

- Bi-metal construction for up to 3x longer life than carbon blades
- Ideal for cutting a wide variety of materials including, rebar, pipe, all thread, and channel



Cutting Wax

- Extends blade life with easier cutting



Model	Part #
2107F/K, XBP01, XBP01T, XBP02, XBP02TX, 2107FZ, 2107FZK,	191897-9

METAL CUTTING BLADES / CARBIDE METAL CUTTING BLADES

STEEL / FERROUS METALS

BURR-FREE CUTTING

Cool to the Touch & Less Cost Per Cut

Carbide tooth Design for longer cutting life



Ultra Thin Kerf for faster more efficient cutting

Modified Triple Chip Grind for increased efficiency and life

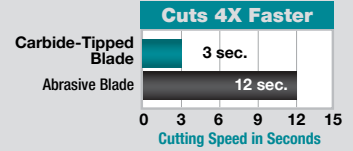
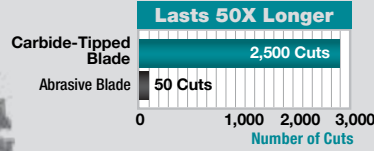

Cutting test performed in 2" x 2" x 1/4" Angle Iron

Diameter	Blade Type	No. Teeth	Arbor	Max. RPM	Application	Model	Part #
5-3/8"	Ferrous Metal	30		4,500	For cutting pipe, angle iron and channel		A-95037
	Ferrous Metal	36		4,500	For cutting spiral duct, conduit pipe, strut, and threaded rod	XSC01T	NEW B-64179
	Ferrous Metal - Thin Gauge	50		4,500	For cutting thin gauge corrugated sheet, metal studs, and more		A-94524
5-7/8"	Ferrous Metal	32		4,680	For cutting pipe, angle iron and channel	XSC02T	A-96095
	Ferrous Metal - Thin Gauge	52		4,680	For cutting thin gauge corrugated sheet, metal studs, and more		A-96104
6-1/4"	Ferrous Metal	46	5/8"	4,770	For cutting pipe, angle iron and channel	5046DWDE	A-90685
	Ferrous Metal - Thin Gauge	56		4,770	For cutting thin gauge corrugated sheet, metal studs, and more		A-90691
7-1/4"	Ferrous Metal	38		5,800	For cutting sheet, metal studs, angle iron, rebar, pipe and tubing	4131	A-93821
	Ferrous Metal	48			For cutting sheet, corrugated, metal studs, angle iron, rebar, pipe and tubing		A-93837
	Ferrous Metal - Thin Gauge	70		For cutting thin gauge sheet, corrugated and metal studs	A-93843		
	Ferrous Metal	36		For cutting sheet, metal studs, angle iron, rebar, pipe and tubing	A-93815*		
12"	Ferrous Metal	60		2,000	For cutting tubing, angle iron, channel and pipe	LC1230	A-90532
	Ferrous Metal	60	1"		For quiet cutting tubing, angle iron, channel and pipe		A-90722
	Ferrous Metal - Thin Gauge	78		For cutting thin gauge tubing, angle iron, channel and pipe	A-90875		
14"	Ferrous Metal - Thin Gauge	70		1,700	For cutting tubing, angle iron, channel and pipe	-	A-97592
14"	Ferrous Metal - Thin Gauge	90	1"	1,700	For cutting thin gauge tubing, angle iron, channel and pipe	-	A-97601 <small>*Cermet tipped</small>

STAINLESS STEEL

Diameter	Blade Type	No. Teeth	Arbor	Max. RPM	Application	Model	Part #
5-3/8"	Stainless Steel - Thin Gauge	56		4,500	For cutting thin gauge tubing, angle iron, channel and sheet	XSC01T	A-95794
5-7/8"	Stainless Steel	60	5/8"	4,680		XSC02T	A-96110
7-1/4"	Stainless Steel - Thin Gauge	64		5,800		4131	A-95875
12"	Stainless Steel	76	1"	1,500		LC1230	A-91039

ALUMINUM

Diameter	Blade Type	No. Teeth	Arbor	Max. RPM	Application	Model	Part #
5-3/8"	Aluminum	50		4,500	For cutting thin gauge tubing, angle iron, channel and sheet	XSC01T	A-95940
		52	5/8"	4,680		XSC02T	A-96126
4-5/8"	Aluminum	6	20 mm	12,940	Cuts a 90° groove in aluminum sheet materials (3 mm)		A-96132
			20 mm	12,940	Cuts a 135° groove in aluminum sheet materials	CA5000X	A-96148
			20 mm	12,940	Cuts a 90° groove in aluminum sheet materials (2 mm)		A-99926

CARBIDE-TIPPED

Diameter	Blade Type	No. Teeth	Arbor	Max. RPM	Application	Model	Part #
4-5/16"	Carbide-Tipped	24	-	-	For cutting rebar and steel rod	XCS02	SC19002890

NEW

MAX EFFICIENCY

CUTS FASTER | MORE CUTS PER CHARGE

The new Max Efficiency saw blade features high grade Tungsten Carbide tips that are engineered for longer blade life and up to 70% faster cutting and run time compared to standard blades.

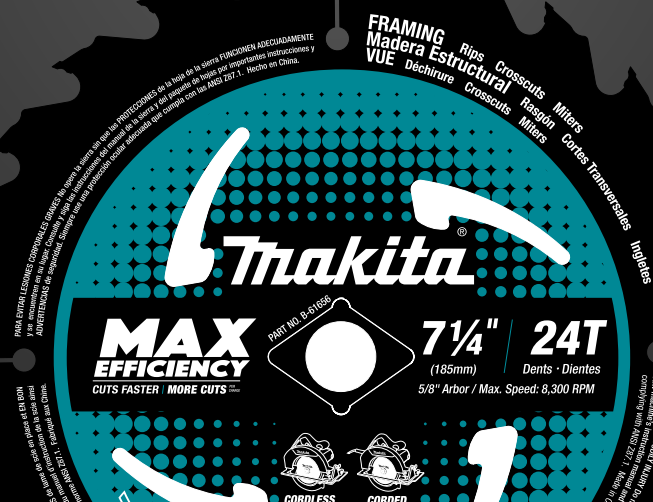

Reduced swing width allows for smoother material removal with less cutting resistance



Ultra-thin 0.057" kerf reduces the load put on the tool



General Contractor



Framing



Framing

Diameter	Blade Type	No. Teeth	Arbor	Grind	Hook	Plate	Kerf	Max. RPM	Model	Part #
3-3/8"	General Purpose	20T	15mm	ATB	20°	.028"	.039"	2,240	SH01W, SH01ZW	A-95021
3-3/8"	General Purpose	24T	15mm	ATB	24°	.039"	.078"	2,240		721005-A
4-3/8"	General Purpose	12T	20mm	ATB	22°	.049"	.073"	13,890		A-90093
4-3/8"	General Purpose	24T	20mm	ATB	10°	.055"	.078"	13,890	4200NH	721107-6A
5-3/8"	General Purpose	16T	5/8"	ATAF	20°	.039"	.059"	4,500	XSS03	A-94904
5-1/2"	General Purpose	18T	5/8"	ATB	20°	.055"	.078"	10,900	5005BA	792335-0
For Use with Cordless Plunge Saws										
6-1/2"	Crosscutting	48T	20mm	ATB	8°	.062"	.087"	9,250	SP6000J/J1, XPS01/2	B-07353*
6-1/2"	General Purpose	28T	20mm	ATB	23°	.055"	.079"	9,250		A-99960
6-1/2"	Corian®	48T	20mm	TCG	5°	.055"	.079"	9,250	XPS01PTJ, XPS02ZU	A-98809
6-1/2"	Crosscutting	48T	20mm	ATB	8°	.049"	.073"	9,250		A-99932
6-1/2"	Aluminum	56T	20mm	TCG	-3°	.055"	.079"	9,250		A-99976
6-1/2"	Crosscutting	56T	20mm	ATAF	23°	.039"	.057"	9,250	XPS01PTJ, XPS02ZU	B-57342
6-1/2"	Crosscutting	60T	20mm	ATB	5°	.055"	.079"	9,250		A-99982
6-1/2"	Crosscutting	60T	20mm	TCG	5°	.055"	.079"	9,250		A-99998
6-1/2"	General Purpose	16T	5/8"	ATAF	20°	.039"	.059"	4,770		T-01395
6-1/2"	General Purpose	24T	5/8"	ATB	20°	.039"	.059"	6,500		A-85092
6-1/2"	Framing	24T	5/8"	ATAF	20°	.039"	.059"	4,770	XSH03, XSS01	T-01404
6-1/2"	Framing	25T	5/8"	ATAFR	23°	0.039"	.055"	9,250		B-62963
6-1/2"	Crosscutting	40T	5/8"	ATB	18°	.039"	.063"	4,770		A-90314
6-1/2"	General Purpose	40T	5/8"	ATAF	18°	.039"	.059"	4,770		T-01410
7-1/4"	Framing	24T	5/8"	ATAFR	23°	0.039"	.057"	8,300		B-61656 / B-61656-10 (10/pk)
7-1/4"	General Contractor	16T	5/8"	ATB	25°	.049"	.073"	8,300		A-90009-B-10 (10/pk)
7-1/4"	General Contractor	24T	5/8"	ATB	15°	.047"	.071"	8,300	XSR01, XSH06, 5007F, 5007FA, 5007MG, 5007MGA, 5377MG, HS7600, 5477 NB, XSH01, XSR01, 5007NK	D-45989-10 (10/pk)
7-1/4"	Framing	24T	5/8"	"M"	15°	.047"	.071"	8,300		A-94839-10 (10/pk)
7-1/4"	Ultra-Coated Framing	24T	5/8"	"M"	15°	.047"	.071"	8,300		A-94530-10 (10/pk)
7-1/4"	Fine Crosscutting	40T	5/8"	ATB	20°	.049"	.073"	8,500		721251-A
8-1/4"	Framing	24T	5/8"	ATB	20°	.051"	.078"	5,700		D-21521
8-1/4"	Fine Crosscutting	40T	5/8"	ATB	20°	.055"	.079"	5,700	5008MGA	792377-A
10-1/4"	Framing	24T	5/8"	ATB	20°	.063"	.091"	5,870	5104, HS0600	A-94910
16-5/16"	Beam & Timber	32T	1"	ATB	20°	.07"	.109"	3,500		A-90956
16-5/16"	Beam & Timber	60T	1"	ATB	20°	.078"	.109"	3,500	5402NA	792118-8

2-Pc. 6-1/2" Carbide-Tipped Circular Saw Blade Set

- Ultra-Thin Kerf carbide-tipped design provides smoother cuts with less drag on the motor and minimal material loss
- 1 ea. 16T and 24T 6-1/2" Carbide-Tipped Circular Saw Blade



Model	Part #
XSH03, XSS01	T-01426

*Indicates cordless models
*Can be used with both corded and cordless models

STEEL SAW BLADES

Diameter	Blade Type	No. Teeth	Arbor	Grind	Hook	Plate	Kerf	Max. RPM	Model	Part #
3-3/8"	General Purpose	50T	15mm	—	—	.031"	.046"	2,240	SH01W	721003-8
3-3/8"	Thin Materials	50T	15mm	—	—	.015"	.031"	2,240	SH01W	792299-8
16-5/16"	General Purpose	50T	1"	Chisel	20°	.062"	.093"	2,760	5402NA	792116-8



MITER SAW BLADES

MAX EFFICIENCY
CUTS FASTER | MORE CUTS PER CHARGE



THE NEXT GENERATION OF ACCESSORIES

ENGINEERED TO DELIVER OPTIMAL & EFFICIENT CUTTING SOLUTIONS

Max Efficiency



Diameter	Blade Type	No. Teeth	Arbor	Grind	Hook	Plate	Kerf	Max. RPM	Model	Part #
10"	Ultra Plus Premium Ripping/Crosscutting	45T	5/8"	ATAFR	10°	0.065"	.085"	5,870		B-62103
10"	Ultra Plus Premium Smooth Crosscutting	60T	5/8"	ATAFR	10°	0.065"	.085"	5,870	LS1018, LS101L, LS1040	B-66961
10"	Ultra Plus Premium Fine Finish Crosscutting	80T	5/8"	ATAFR	10°	0.065"	.085"	5,870		B-66977
12"	Ultra Plus Premium Ripping/Crosscutting	60T	1"	ATAFR	10°	0.065"	.085"	5,000		B-66983
12"	Ultra Plus Premium Smooth Crosscutting	80T	1"	ATAFR	10°	0.065"	.085"	5,000	LS1216L, LS1219L, LS1221	B-66999
12"	Ultra Plus Premium Fine Finish Crosscutting	100T	1"	ATAFR	10°	0.065"	.085"	5,000		B-67000

Premium Ultra-Coated



Diameter	Blade Type	Application	No. Teeth	Arbor	Grind	Hook	Plate	Kerf	Max. RPM	Model	Part#
7-1/2"	Crosscutting	Hardwood, Softwood, Plywood, Fine Finish	40	5/8"	ATB	-18°	.055"	.075"	3,000	XSL01	A-90912
7-1/2"	Crosscutting	Hardwood, Softwood, Plywood	40	5/8"	ATAF	10°	.055"	.079"	8,040	XSL01, XSC02	A-90629
7-1/2"	Crosscutting	Hardwood, Softwood, Plywood	72	5/8"	ATAF	15°	.055"	.079"	8,040		A-94487
8-1/2"	Crosscutting	Hardwood, Softwood, Plywood	48	5/8"	ATB	5°	—	.094"	7,070	LS0815F	A-95934
10"	Premium Crosscutting (Ultra-Coated)	Construction, Lumber, Plastics	40	5/8"	ATAF	5°	.071"	.091"	5,870		A-94758
10"	Premium Smooth Crosscutting (Ultra-Coated)	Particleboard, Laminates	60	5/8"	ATAF	5°	.071"	.091"	5,870	LS1018, LS101L, LS1040	A-94764
10"	Premium Fine Crosscutting (Ultra-Coated)	Hardwood, Softwood, Plywood	80	5/8"	ATAF	5°	.071"	.091"	5,870		A-94770
12"	Premium Crosscutting (Ultra-Coated)	Construction, Lumber, Plastics	40	1"	ATAF	5°	.071"	.091"	5,000		A-94786
12"	Premium Crosscutting (Ultra-Coated)	Construction, Lumber, Plastics	60	1"	ATAF	5°	.071"	.091"	5,000		A-94792
12"	Premium Smooth Crosscutting (Ultra-Coated)	Hardwood, Softwood, Plywood	80	1"	ATAF	5°	.071"	.091"	5,000	LS1216L, LS1219L, LS1221	A-94801
12"	Premium Ultra-Fine Crosscutting (Ultra-Coated)	Hardwood	100	1"	ATAF	5°	.071"	.091"	5,000		A-94817
12"	Premium Crosscutting (Ultra-Coated)	Hardwood, Softwood, Plywood	70	1"	ATB	0°	.075"	.098"	5,000		A-94443
14"	Crosscutting	Hardwood, Softwood, Plywood	80	1"	ATAF	20°	.094"	.134"	4,300	LS1440	792297-7A

◀ Indicates cordless models

Micro-Polished



Diameter	Blade Type	Application	No. Teeth	Arbor	Grind	Hook	Plate	Kerf	Max. RPM	Model	Part #
10"	Crosscutting (Micro-Polished)	Construction Lumber, Plastics	40	5/8"	ATAF	5°	.071"	.091"	5,870		A-93669
10"	Smooth Crosscutting (Micro-Polished)	Particleboard, Laminates	60	5/8"	ATAF	5°	.071"	.091"	5,870	LS1018, LS1019L, LS1040	A-93675
10"	Fine Crosscutting (Micro-Polished)	Hardwood, Softwood, Plywood	70	5/8"	ATAF	5°	.071"	.091"	5,870		A-93550
10"	Fine Crosscutting (Micro-Polished)	Hardwood, Softwood, Plywood	80	5/8"	ATAF	5°	.071"	.091"	5,870		A-93681
12"	Crosscutting (Micro-Polished)	Construction Lumber, Plastics	40	1"	ATAF	5°	.071"	.091"	5,000		A-93706
12"	Smooth Crosscutting (Micro-Polish)	Particleboard, Laminates	60	1"	ATAF	5°	.071"	.091"	5,000	LS1216L, LS1219L, LS1221	A-93712
12"	Fine Crosscutting (Micro-Polished)	Hardwood, Softwood, Plywood	80	1"	ATAF	5°	.071"	.091"	5,000		A-93728
12"	Ultra-Fine Crosscutting (Micro-Polished)	Hardwood	100	1"	ATAF	5°	.071"	.091"	5,000		A-93734

TABLE SAW BLADES



Diameter	Blade Type	Application	No. Teeth	Arbor	Grind	Hook	Plate	Kerf	Max. RPM	Model	Part #
10"	Ripping	General Purpose	24	5/8"	ATB	20°	.071"	.098"	5,990	2703, 2704, 2705	792736-2
10"	Ripping, Crosscutting	Thick/Thin, Hard/Soft Wood	32	5/8"	ATAF	20°	.071"	.102"	5,870	2703, 2704, 2705	A-94948

- Fully hardened and expertly hand-tensioned steel saw plates for true cuts

FIBER-CEMENT SAW BLADES



Diameter	Blade Type	No. Teeth	Arbor	Grind	Hook	Plate	Kerf	Max. RPM	Application	Model	Part #
4"	Carbide-Tipped	16T	20mm	ATAF	10°	.046"	.062"	15,200	Fiber-Cement Siding, Roofing, Backerboard	5044KB	A-90439
7-1/4"	Carbide-Tipped	28T	5/8"	ATB	10°	.059"	.079"	8,250	Fiber-Cement Siding, Roofing, Backerboard		A-90451
7-1/4"	Diamond-Tipped	4T	5/8"	FTG	12°	.063"	.087"	8,000	Fiber-Cement Siding, Roofing, Backerboard	5057KB	A-95124
10"	Diamond-Tipped	6T	5/8"	FTG	8°	.071"	.090"	5,870	Multi-Plank	LS1016L, LS1019L, LS1018, LS1040	A-95130
12"	Diamond-Tipped	8T	1"	FTG	8°	.071"	.098"	5,000	Multi-Plank	LS1216L, LS1219L, LS1221	A-95146

- Designed for cutting fiber-cement materials
- Exclusive Makita heat vents reduce heat that causes build-up

INDUSTRIAL RECIPROCATING SAW BLADES

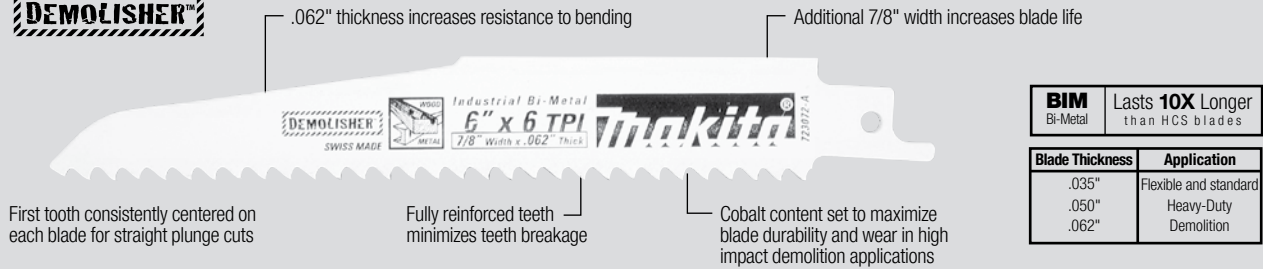

BIM Bi-Metal	Lasts 10X Longer than HCS blades
Blade Thickness	Application
.035"	Flexible and standard
.050"	Heavy-Duty
.062"	Demolition

Demolition

Length	TPI	Width	Thickness	Material	Type	Application	3/Pkg. Part #	25/Pkg. Part #	100/Pkg. Part #
6"	6	7/8"	.062"	BIM	Taper Back	Demolition without blades bending in nail embedded wood, drywall	723072-A-3	-	-
9"	6	7/8"	.062"	BIM	Taper Back	Demolition without blades bending in nail embedded wood, drywall	723073-A-3	723073-A-25	-
12"	6	7/8"	.062"	BIM	Taper Back	Demolition without blades bending in nail embedded wood, drywall	723074-A-3	-	-
6"	8/10	7/8"	.062"	BIM	Taper Back	Demolition without blades bending in metal, pipe, channels, angle iron	723075-A-3	-	-
9"	8/10	7/8"	.062"	BIM	Taper Back	Demolition without blades bending in metal, pipe, channels, angle iron	723076-A-3	723076-A-25	-
12"	8/10	7/8"	.062"	BIM	Taper Back	Demolition without blades bending in metal, pipe, channels, angle iron	T-02048	-	T-02054

Wood Cutting

Length	TPI	Width	Thickness	Material	Type	Application	5/Pkg. Part #	25/Pkg. Part #	100/Pkg. Part #
4"	6	3/4"	.035"	BIM	Taper Back	Nail embedded wood, plastic, composite materials	B-20432	-	-
9"	3	3/4"	.050"	HCS	Taper Back	Very fast & aggressive cuts in green wood, firewood from 5/8" - 6"	723053-A-5	-	-
9"	6	3/4"	.050"	HCS	Taper Back	Fast aggressive cuts in green wood, pruning tree branches, firewood from 5/8" - 6"	723052-A-5	-	-
6"	6	3/4"	.050"	BIM	Straight Back	Fast cutting, nail embedded wood, insulating board, composition, light metal	723058-A-5	-	-
6"	6	3/4"	.050"	BIM	Taper Back	Nail embedded wood, hard & soft wood, particleboard, plastic pipe from 1/4" - 4"	723054-A-5	-	723054-A-100
9"	6	3/4"	.050"	BIM	Taper Back	Fast cutting, nail embedded wood, insulating board, plywood, plastic pipe from 1/4" - 7"	723055-A-5	723055-A-25	723055-A-100
12"	6	3/4"	.050"	BIM	Taper Back	Fast cutting, nail embedded wood, insulating board, plywood, plastic pipe from 1/4" - 10"	723056-A-5	723056-A-25	723056-A-100
6"	6	3/4"	.050"	HCS	Taper Back	Fast & rough-in cuts in wood, plywood, particleboard, plastic from 1/4" - 4"	723050-A-5	-	-
12"	6	3/4"	.050"	HCS	Taper Back	Fast & rough-in cuts in wood, plywood, particleboard, plastic from 1/4" - 10"	723051-A-5	-	-

All-Purpose

Length	TPI	Width	Thickness	Material	Type	Application	5/Pkg. Part #	25/Pkg. Part #	100/Pkg. Part #
6"	10	3/4"	.035"	BIM	Straight Back	Nail embedded wood, metal, bar & pipe over 1/4"	723064-A-5	723064-A-25	-
6"	10/14	3/4"	.035"	BIM	Straight Back	Nail embedded wood, composition, metal, plastic	723068-A-5	-	-
9"	10/14	3/4"	.035"	BIM	Straight Back	Nail embedded wood, composition, metal, plastic	723070-A-5	723070-A-25	723070-A-100
12"	10/14	3/4"	.035"	BIM	Straight Back	Nail embedded wood, composition, metal, plastic	723071-A-5	723071-A-25	-

Metal Cutting

Length	TPI	Width	Thickness	Material	Type	Application	5/Pkg. Part #	25/Pkg. Part #	100/Pkg. Part #
3-1/2"	18	Scroll	.035"	BIM	Scroll	Pipe, conduit, channel, metal from 3/16" - 1/4"	723061-A-5	-	-
4"	14	3/4"	.035"	BIM	Straight Back	Irregular cuts in metal under 1/8"	723062-A-5	-	-
6"	14	3/4"	.035"	BIM	Straight Back	Pipe, conduit, channel, metal from 3/16" - 1/4"	723065-A-5	-	723065-A-100
4"	18	3/4"	.035"	BIM	Straight Back	Heavy gauge metal from 1/8" - 3/16", hard rubber	723063-A-5	-	-
6"	18	3/4"	.035"	BIM	Straight Back	Pipe, conduit, channels, metal from 1/8" - 3/16"	723066-A-5	723066-A-25	723066-A-100
9"	18	3/4"	.035"	BIM	Straight Back	Bar & angle stock, galvanized pipe, stainless, metal from 1/8" - 3/16"	723069-A-5	-	-
6"	24	3/4"	.035"	BIM	Straight Back	Pipe, conduit, channel, thin gauge metal from 18 gauge to 1/8"	723067-A-5	723067-A-25	-

Specialty

Length	TPI	Width	Thickness	Material	Type	Application	2/Pkg. Part #	5/Pkg. Part #
6"	6	3/4"	.050"	BIM	Taper Back	Drywall, plaster, plastic from 5/16" - 4"	-	723060-A-5
8"	Coarse	3/4"	.040"	GRIT	Straight Back	Brick, tile, marble, stone, chalkboard, cast iron pipe, melamine, veneer, fiberglass	723077-A-2	-

Cordless

Length	TPI	Width	Thickness	Material	Type	Application	5/Pkg. Part #
6"	Progressive	3/4"	.035"	BIM	Taper Back	Progressive tooth spacing for fast cuts in metal, conduit, plastic	723079-A-5
6"	Progressive	3/4"	.050"	BIM	Taper Back	Progressive tooth spacing for all-purpose fast cuts in variety of wood, metal, plastic	723080-A-5
6"	Progressive	3/4"	.035"	BIM	Taper Back	Fast cuts in metal, conduit and plastic	723082-A-5
6"	Progressive	3/4"	.035"	BIM	Taper Back	Fast cuts in a variety of materials including wood and metal	723083-A-5
8"	Progressive	3/4"	.050"	HCS	Taper Back	Progressive tooth spacing for fast & clean cuts in thick & thin wood from 1/4" - 4"	723078-A-5
8"	Progressive	3/4"	.035"	HCS	Taper Back	Fast cuts in thick and thin wood from 1/4" to 4"	723081-A-5

Reciprocating Blade Sets

Description	Part #
-------------	--------

6-Pc. Bi-Metal Pack - (1) each: 6723054-A, 723064-A, 723066-A, 723061-A, 723079-A, 723080-A

723086-A-A

RECIPROCATING / JIG-SAW / CUT-OUT SAW BLADES

INDUSTRIAL RECIPROCATING SAW BLADES

Exclusively for use with Makita Shank Cordless Reciprocating Saw



Thin kerf for faster cuts and longer battery life

Length	TPI	Type	Application	Model	Part #
4"	24	Taper Back	Mild steel, plywood	4390D/DW	792540-9
4-3/4"	9	Taper Back	General purpose wood cutting		792541-7
5-7/8"	9	Taper Back	General purpose wood cutting		792616-2
5-7/8"	24	Taper Back	Masonite, formica, plastics		792615-4

CUT-OUT SAW BLADES

Description	Model	Part #	Description	Model	Part #
<p>Cut-Out Saw Blade, Drywall</p> <ul style="list-style-type: none"> For making precision cuts in drywall Cuts drywall up to 1-3/16" thick 	XDS01	B-49703	<p>Cut-Out Saw Blade, Wood</p> <ul style="list-style-type: none"> For making precision cuts in wood Cuts drywall up to 9/16" thick 	XDS01	B-49719

JIG SAW BLADES

"T" (Tang) Shank

Fits all "T" (Tang) Shank Jig Saws



Expertly ground, reinforced teeth engineered for clean, fast cuts and reduced blade stress

Overall Length	Cutting Length	TPI	Material	Blade No.	Application	Wood	Plastic	Aluminum	Stainless	Mild Steel	5/Pkg. Part #
3"	1-3/4"	14	HCS	B-18	Scroll cutting of wood and plastics	1/8" to 1-3/8"	1/8" to 1-3/8"				792470-4
3"	2"	14	HSS	B-23	Decorative veneers	1/8" to 1-3/8"	1/8" to 1-3/8"	1/8" to 1/4"		1/16" to 1/4"	792474-6
3"	2"	18	HCS	B14	Thin materials	1/16" to 1-3/8"	1/16" to 1-3/8"				792466-5
3"	2"	18	HCS	B-15	Thin materials	1/8" to 1-3/8"	1/8" to 1-3/8"				792467-3
3"	2"	24	HSS	B-22	Mild steel, stainless steel & tough plastics		3/64" to 15/64"	1/16" to 1/8"	1/16" to 1/8"	1/16" to 1/8"	792473-8
3"	2"	24	HSS	B-27	Scroll cutting in mild steel		1/16" to 1/4"	1/16" to 1/8"	1/16" to 1/8"	1/16" to 1/8"	792478-8
3"	2"	32	HSS	B-24	Thin mild & stainless steel		3/64" to 1/8"	1/16" to 1/8"	1/16" to 1/8"	1/16" to 1/8"	792475-4
3-1/2"	2-1/2"	12	HSS	B-19	Decorative veneers with splinter-free down cutting teeth	1/8" to 2"	1/8" to 2"				792471-2
3-1/2"	2-1/2"	24	HSS	#51	Mild steel		1/16" to 3/16"	1/16" to 3/16"	1/16" to 1/8"	1/16" to 1/8"	792428-3
3-7/8"	2-3/4"	6	HCS	B-17	Scroll cutting in wood & plastics (Fast cutting)	3/16" to 2-3/8"	3/16" to 2-3/8"				792469-9
3-7/8"	2-3/4"	9	HSS	B-26	Scroll cutting in hardwoods & plastics	1/8" to 2-3/8"	1/8" to 2-3/8"	1/8" to 3/8"		1/8" to 3/8"	792477-0
3-7/8"	3"	9	HCS	B-11	Fast finish work in wood and plastics	1/8" to 2-3/8"	1/8" to 2-3/8"				792463-1
3-7/8"	3"	9	HSS	B-25	Hardwood, thick mild steel plate and tough plastics	1/8" to 2-3/8"	1/8" to 2-3/8"	1/8" to 1/4"	1/8" to 1/4"		792476-2
3-7/8"	3"	12	HSS	B-21	Finish work, plastics & aluminum	1/8" to 2-3/8"	1/16" to 3/8"				792472-0
4-1/8"	2-3/4"	6	HCS	B-16	Fast cutting of wood and plastics	3/16" to 2-9/16"	3/16" to 2-9/16"				792468-1
4-1/8"	3-1/8"	6	HCS	B-12	Fast finish work in wood and plastics	3/16" to 2-9/16"	3/16" to 2-9/16"				792464-9
4-1/8"	3-1/8"	8	HCS	B-13	General cutting of wood and plastics	3/16" to 2-9/16"	3/16" to 2-9/16"				792465-7
4-1/8"	3-1/8"	8	HCS	#58	Fast cutting of wood and plastics	3/16" to 2-9/16"	3/16" to 2-9/16"				792429-1
4-1/8"	3-1/8"	8	HCS	#59	Fast finish work in wood and plastics	3/16" to 2-9/16"	3/16" to 2-9/16"				792430-6
4-1/8"	2-1/2"	9	HCS	BR-13	Splinter-free cuts in wood with no sanding	3/16" to 2-9/16"					792729-9
4-1/8"	3-1/8"	9	HCS	B-10	Fast finish work, especially in plywood	1/8" to 2-9/16"	1/8" to 2-9/16"				792529-7
7-1/8"	5-7/8"	6	HCS	B-16L	Thick materials	3/16" to 5-1/4"	3/16" to 5-1/4"				792730-4

JIG SAW BLADES (MAKITA® SHANK)

Exclusively for use with Makita Shank Jig Saws



Blade designed for clean cuts and reduced deflection

Makita Shank

Overall Length	Cutting Length	TPI	Material	Blade No.	Application	Wood	Plastic	Aluminum	Stainless	Mild Steel	Model	2/Pkg. Part #
2-3/8"	1-5/8"	24	HSS	#5	Mild steel		1/16" to 1/4"	1/16" to 1/8"	1/16" to 1/8"	1/16" to 1/8"		723008-4-2
3-1/8"	2-3/8"	8	HCS	#8	Fast finish scroll cutting of wood & plastics	3/16" to 2"	3/16" to 2"					723023-8-2
3-1/8"	2-3/8"	8	HCS	#9	Fast finish work in wood & plastics	3/16" to 2"	3/16" to 2"					723024-6-2
3-1/8"	2-3/8"	8	HCS	#10	Fast finish work, good in plywood	3/16" to 2"	3/16" to 2"					723025-4-2
3-1/8"	2-3/8"	9	HCS	#3	General cutting of wood & plastics	1/8" to 2"	1/8" to 2"				4301BV,	723010-7-2
3-1/8"	2-3/8"	9	HCS	#16	Scroll cutting of wood & plastics	1/8" to 2"	1/8" to 2"				4304/T,	792211-8-2
3-1/8"	2-3/8"	9	HSS	#4	Hardwood/thick mild steel plate & tough plastics	1/8" to 2"	1/8" to 2"	1/8" to 1/4"		1/8" to 1/4"	4305/T,	723011-5-2
3-1/8"	2-3/8"	12	HSS	#41	Plastics & decorative veneers (Splinter-free down cutting teeth)	1/8" to 2"	1/8" to 2"				4300D/DW,	792396-0-2
3-1/8"	2-3/8"	12	HSS	#39	General cutting of wood	1/8" to 2"					4307D/DW	792222-3 (5/pkg)
3-1/8"	2-3/8"	14	HSS	#17	Scroll cutting of decorative veneer	1/16" to 2"	1/16" to 2"	1/16" to 1/4"		1/16" to 1/4"		792214-2-2
3-1/8"	2-3/8"	14	HSS	#2	Decorative veneers	1/8" to 2"	1/8" to 2"	1/16" to 1/4"		1/16" to 1/4"		723009-2-2
3-1/8"	2-1/8"	15	HSS	#42	Decorative veneers	1/16" to 2"	1/16" to 2"					792395-2-2
3-1/8"	2-1/8"	24	HSS	#1	Mild steel, stainless steel Also for corrugated plastics and tough plastics	1/16" to 1/4"	1/16" to 1/8"	1/16" to 1/8"		1/16" to 1/8"		723012-3-2

STRAIGHT & GROOVE FORMING BITS

Straight - Single Flute

For rough routing, grooving and general stock removal. Single flute gives more efficient chip clearance for improved feed rates. 1/2" shank bits are for maximum strength production use.

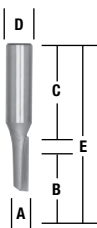

Solid Carbide*

A	B	C	D	E	Part #
1/8	7/16	1-3/8	1/4	2	733003-1A

*Solid carbide cutting edge

Carbide-Tipped

A	B	C	D	E	Part #
1/4	1	1-3/16	1/4	2	733001-0A
1/2	2	2-1/16	1/2	4-1/4	733002-6A

Straight - 2 Flute

For general purpose routing and grooving where smoothness of cut and minimal vibration are desired.

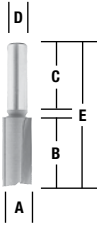

Solid Carbide*

A	B	C	D	E	Part #
1/16	3/16	1-1/8	1/4	1-5/8	733250-A

*Solid carbide cutting edge

Carbide-Tipped

A	B	C	D	E	Part #
3/16	7/16	1-3/8	1/4	2	733003-2A
1/4	3/4	1-3/16	1/4	2	733003-4A
1/4	1	1-3/16	1/4	2-1/4	733003-6A
5/16	1	1-1/8	1/4	2-1/4	733003-8A
3/8	1	1-1/8	1/4	2-1/4	733004-0A
3/8	1	1-1/4	1/2	2-3/4	733005-4A
7/16	1	1	1/4	2-1/8	733004-1A
1/2	1	1-1/8	1/4	2-1/8	733004-2A
1/2	1	1-5/16	1/2	2-5/8	733252-A
1/2	1-1/4	1-7/16	1/2	2-7/8	733005-6A
1/2	1-1/2	1-1/4	1/2	3-1/8	733005-8A
1/2	2	2	1/2	4-1/4	733005-9A
1/2	2-1/2	1-1/16	1/2	4-1/2	733254-A
5/8	3/4	1-1/8	1/4	2	733004-4A
3/4	3/4	1-1/8	1/4	2	733004-6A
3/4	1-1/4	1-1/4	1/2	2-7/8	733006-4A
7/8	1-1/4	1-3/16	1/2	2-7/8	733006-6A
1	1-1/4	1-3/16	1/2	2-7/8	733006-8A
1-1/4	1-1/4	1-7/16	1/2	2-7/8	733257-A

Hinge Mortising - 2 Flute

For fast stock removal, grooving, dados and hinge butt template work. Deep center gullet provides good chip clearance.

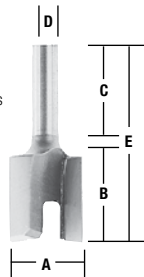

Carbide-Tipped

A	B	C	D	E	Part #
1/2	3/4	1-1/16	1/4	2	733006-9A

Core Box

For high-quality radius cuts, rounded grooves, letter cutting, beading, fluting and general ornamentation.

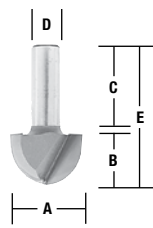

Carbide-Tipped

Radius	A	B	C	D	E	Part #
1/8	1/4	1/4	1-1/4	1/4	1-5/8	733008-2A
3/16	3/8	1/4	1-1/4	1/4	1-1/2	733008-4A
1/4	1/2	3/8	1-1/4	1/4	1-1/2	733008-6A
5/16	5/8	7/16	1-1/4	1/4	1-1/2	733008-8A
3/8	3/4	7/16	1-1/4	1/4	1-1/2	733009-0A
1/2	1	5/8	15/16	1/4	1-3/4	733270-A

90° Vee Grooving - 2 Flute

For sign lettering, decorative work, plank simulation on panels, and cabinet door grooving. Recommended maximum depth of cut is not greater than half of the cutting diameter, F.

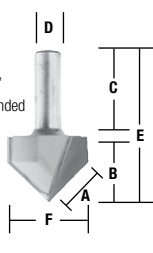

Carbide-Tipped

A	B	C	D	E	F	Part #
1/4	7/16	1-3/16	1/4	1-5/8	3/8	733009-2A
7/16	1/2	1-5/16	1/4	1-5/8	5/8	733009-4A
9/16	5/8	1	1/4	1-7/8	7/8	733009-5A

Dovetail Flute

For smooth dovetail joints and drawer fingers.

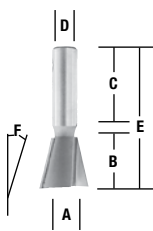

Carbide-Tipped

A	B	C	D	E	F	Part #
1/2	1/2	1-3/16	1/4	1-1/4	14°	733009-6A

Panel Pilot - Single Flute

For fast door and window cutouts through covering sheets. Drill-thru pilot point allows fast plunging and acts as pilot for guiding on framing after panels have been mounted.

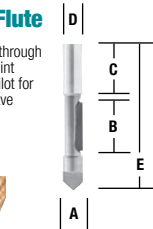

Carbide-Tipped

A	B	C	D	E	Part #
1/4	3/4	1	1/4	2-1/2	733030-2A
3/8	1	1	3/8	3	733030-4A
1/2	1-3/16	1-1/2	1/2	3-1/2	733030-6A

Top Bearing (Straight) - 2 Flute

For cutting grooves, dados and rabbets where template is on top of the workpiece. Cuts flush with bearing to give exact duplication of template.

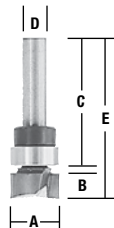

Carbide-Tipped

A	B	C	D	E	Part #
1/2	1/4	1	1/4	1-5/8	733325-A
1/2	1	1-1/4	1/4	2-1/2	733012-1A
5/8	1	7/8	1/2	2-3/4	733258-A
3/4	1	13/16	1/4	2-1/2	733259-A

Keyhole Slot

Plunge cut followed by a side movement of router produces the slot for screw and nail heads for mounting picture frames, plaques, etc.

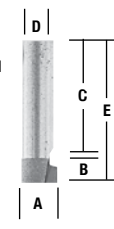

Carbide-Tipped

A	B	C	D	E	Part #
3/8	3/8	1	1/4	1-1/2	733010-1A

EDGE FORMING BITS

Corner Rounding - 2 Flute

For smooth decorative edge rounding or molding. Lower depth setting produces a rounded corner with a decorative bead.



1 MAX. RPM: 14,000

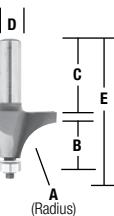

Carbide-Tipped Ball Bearing Pilot

A	B	C	D	E	Dia	Part #
1/8	3/8	1-1/4	1/4	2	3/4	733120-1A
3/16	1/2	1-1/4	1/4	2	7/8	733120-0A
1/4	1/2	1-1/4	1/4	2	1	733120-2A
1/4	1/2	1-5/16	1/2	2-1/8	1	733291-A
5/16	1/2	1-1/4	1/4	2-1/16	1-1/8	733120-4A
3/8	5/8	1-1/4	1/4	2-3/16	1-1/4	733120-6A
1/2	3/4	1-1/4	1/4	2-1/4	1-1/2	733120-8A
3/8	5/8	1-1/2	1/2	2-9/16	1-1/4	733121-0A
1/2	3/4	1-1/2	1/2	2-5/8	1-1/2	733121-2A
5/8	7/8	1-5/16	1/2	2-3/8	1-3/4	733292-A
3/4	1	1-5/16	1/2	2-3/8	2	733293-A
1	1-1/4	1-3/8	1/2	2-3/16	2-1/2	733329-A

Beading - 2 Flute

For decorative molding or edging. Rounds corners and produces small edge beads. Shallower depth setting eliminates top edge bead.

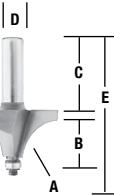

Carbide-Tipped Ball Bearing Pilot

A	B	C	D	E	Dia	Part #
3/16	1/2	1-1/4	1/4	2	7/8	733121-4A
1/4	1/2	1-1/4	1/4	2	1	733121-6A
5/16	1/2	1-1/4	1/4	2-1/16	1-1/8	733121-8A
3/8	5/8	1-1/4	1/4	2-3/16	1-1/4	733122-0A
1/2	3/4	1-1/4	1/4	2-1/4	1-1/2	733122-2A

EDGE FORMING BITS (CONT'D)

Cove - 2 Flute

For decorative molding or edging. Produces inverted radii.

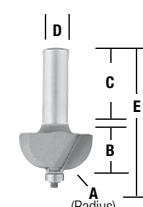

Carbide-Tipped Ball Bearing Pilot

A	B	C	D	E	Dia	Part #
1/4	9/16	1	1/4	2	7/8	733122-6A
3/8	9/16	1	1/4	2	1-1/8	733122-8A
1/2	3/4	1	1/4	2-1/4	1-3/8	733123-0A

Chamfering

For decorative molding bevel edging and mitered edging of panel joints.

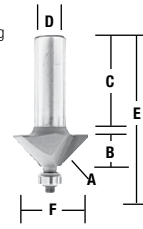

Carbide-Tipped Ball Bearing Pilot

A	B	C	D	E	Degree	F	Part #
5/8	1/2	1-1/4	1/4	2	45°	1-1/4	733124-4A
5/8	1/2	1-15/16	1/2	2-3/8	45°	1-1/4	733285-A
1-1/8	3/4	1-1/4	1/2	2-5/8	45°	2	733286-A
7/8	15/16	1-5/16	1/2	2-7/8	22-1/2°	1-1/4	733288-A

Rabbeting - 2 Flute

For rabbeting or step cutting edges without the use of router edge guides. Self-piloting. Popular in cabinet shops and boat yards.

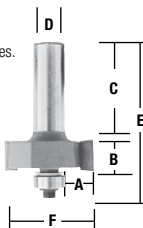

Carbide-Tipped Ball Bearing Pilot

A	B	C	D	E	F	Part #
3/8	1/2	1-7/16	1/4	2	1-1/4	733124-2A
3/8	1/2	1-5/16	1/2	2-3/8	1-1/4	733282-A

Multi-Rabbeting - 2 Flute with 4 Ball Bearings

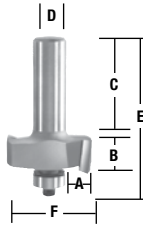

Carbide-Tipped Ball Bearing Pilot

A	B	C	D	E	F	Part #
*	1/2	1-5/16	1/4	2	1-3/8	733283-A
*	1/2	1-5/16	1/2	2-3/8	1-3/8	733284-A

*4 Different Depths of Rabbet: 1/2", 7/16", 3/8" and 5/16"

EDGE FORMING BITS (CONT'D)

Roman Ogee - 2 Flute

For decorative molding or edging. Popular for furniture and cabinet work.

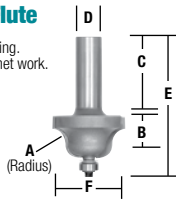

Carbide-Tipped Ball Bearing Pilot

A	B	C	D	E	F	Part #
5/32	5/8	1-1/4	1/4	2-1/8	—	733123-2A
5/32	5/8	1-5/16	1/2	2-1/2	1	733279-A
1/4	7/8	1-1/4	1/4	2-1/4	—	733123-4A
1/4	7/8	1-5/16	1/2	2-5/8	1-3/8	733280-A

Double Roman Ogee - 2 Flute

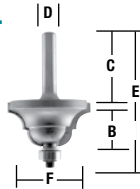

Carbide-Tipped Ball Bearing Pilot

A	B	C	D	E	F	Part #
1/4	7/8	15/16	1/4	2-1/4	1-3/8	733281-A

Classical Bead and Cove

Gives a classical beauty to decorative edging or molding cuts.

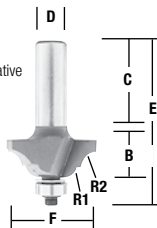

Carbide-Tipped Ball Bearing Pilot

R1	R2	B	C	D	E	F	Part #
13/64	5/16	1/2	1	1/4	2	1-1/4	733125-0A
15/64	7/32	5/8	1	1/4	2-1/8	1-1/2	733125-2A

Classical Cove and Bead

For attractive decorative edges or molding cuts.

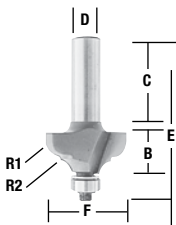

Carbide-Tipped Ball Bearing Pilot

R1	R2	B	C	D	E	F	Part #
5/32	5/32	1/2	1	1/4	2	1-1/8	733126-0A

Ogee with Fillet

Graceful ogee cut for decorative edging and molding cuts. Lower depth setting produces fillet for accent.

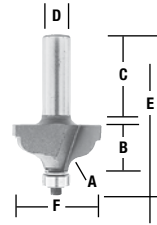

C.T. Ball Bearing Pilot

A	B	C	D	E	F	Part #
5/32	1/2	1	1/4	2-1/16	1-3/8	733125-4A

Wavy Edge

Continuously rounded steps for decorative edging and molding cuts. Resulting surfaces tend to remain dust free in usage.

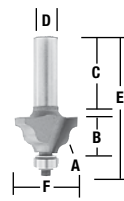

A	B	C	D	E	F	Part #
5/32	11/16	1	1/4	2-1/4	1-1/4	733125-6A

Corner Bead

Attractive edge cut matches many older molding designs. Varying depth setting and more passes create different designs.

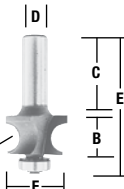

Carbide-Tipped Ball Bearing Pilot

A	B	C	D	E	F	Part #
1/8	9/16	1	1/4	2-1/8	7/8	733125-8A

Bull Nose Bit - 2 Flute

Routs full rounds on edge of workpiece. Can be used on thicker workpieces for full round nose with flats.

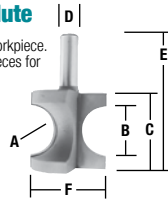

Carbide-Tipped

MAX. RPM: 20,000

A	B	C	D	E	F	Part #
3/8	3/4	1-5/16	1/2	2-3/4	1-1/4	733295-A

Raised Panel Bit (Ogee) - 2 Flute

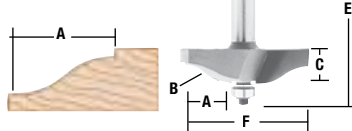

Max. RPM: 14,000 (733305-A)
Max. RPM: 20,000 (733303-A)

Carbide-Tipped Ball Bearing Pilot

A	B	C	D	E	F	Part #
1-1/16	3/4	5/8	1/2	2-1/2	2-5/8	733303-A
1-7/16	7/8	5/8	1/2	2-1/2	3-3/8	733305-A

JOINERY / SLOT CUTTERS

45° Lock Miter Bit

First piece is cut flat and the second is cut perpendicular to the first for a perfect fit. There is no need to realign the router depth, provided that the wood is centered to the cutting edge of the bit.

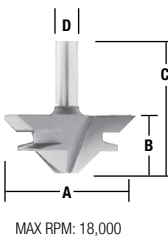

MAX RPM: 18,000

Carbide-Tipped

A	B	C	D	Part #
2-11/16	7/8	2-5/8	1/2	733335-A

JOINERY / SLOT CUTTERS (CONT'D)

2-Pc. Ogee Stile and Rail

Includes two complete assemblies consisting of cutters, arbors, bearings.

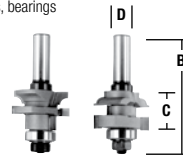
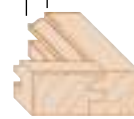

Carbide-Tipped Ball Bearing Pilot

A	B	C	D	Part #
3/8	3-5/16	1-1/16	1/2	733336-A

2-Pc. Bead Stile and Rail

Includes two complete assemblies consisting of cutters, arbors, bearings.

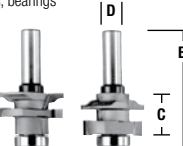
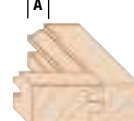

Carbide-Tipped Ball Bearing Pilot

A	B	C	D	Part #
3/8	3-5/16	1-1/16	1/2	733337-A

Reversible 2-Wing Tongue & Groove Assembly

Makes both tongue and groove cut by reversing the assembly. Shims included for perfect alignment for 1/2" - 3/4" material.

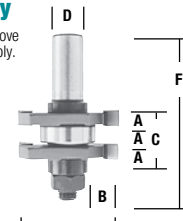

Carbide-Tipped Ball Bearing Pilot

A	B	C	D	E	F	Part #
1/4	3/8	3/4	1/2	1-5/8	3	733307-A

Slotting Cutting Assemblies - 3 Flute

1/2" depth of cut. Smooth cutting slotting bit for weather stripping, "T" molding and splining.

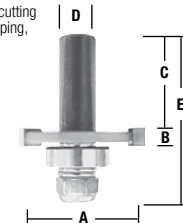

Carbide-Tipped Ball Bearing Pilot

A	B	C	D	E	Part #
1-7/8	5/32	1-1/4	1/4	2-1/8	733300-A
1-7/8	1/8	1-1/4	1/4	2-1/8	733126-4A
1-7/8	3/16	1-1/4	1/4	2-1/8	733126-5A
1-7/8	1/4	1-1/4	1/4	2-1/8	733126-6A

LAMINATE TRIMMING BITS

Supertrim™ Flush Trim

New upshear trim bits for exceptional speed and super-fine finish. Furnished with steel bearing.

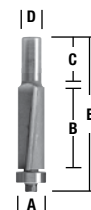

A	B	C	D	E	Part #
3/4	1-1/2	1-1/4	1/2	3-7/8	733326-A

LAMINATE TRIMMING BITS (CONT'D)

Flush Trimmer - Self-Piloting

For flush, square edges on plastic laminates. Small diameter allows intricate and close quarter cuts. No router guides are necessary.

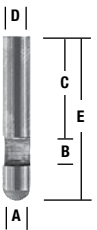

Solid Carbide

A	B	C	D	E	Part #
1/4	1/4	1-1/16	1/4	1-1/2	733128-0A

Flush Trimmer - 2 Flute

For fast, smooth and accurate 90° flush trimming applications. Non marring ball bearing pilot.

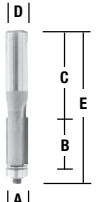

Carbide-Tipped Ball Bearing Pilot

A	B	C	D	E	Part #
1/4	1/2	1	1/4	2-1/4	733128-1A
1/2	9/32	1	1/4	1-7/8	733128-3A
3/8	1/2	1	1/4	2-1/8	733128-7A
3/8	1	1-1/4	1/4	2-5/8	733128-8A
1/2	1/2	1-1/4	1/4	2-1/4	733128-9A
1/2	1	1-1/4	1/4	2-5/8	733129-0A
1/2	1	1-1/4	1/2	3-1/4	733129-1A
1/2	2	1-1/4	1/2	4-1/4	733274-A

Flush Trimmer - 3 Flute

For extra smooth flush 90° trimming and chatter free cuts.

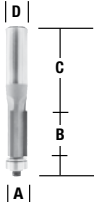

Carbide-Tipped Ball Bearing Pilot

A	B	C	D	E	Part #
1/2	1	1	1/4	2-5/8	733129-3A

No File™ Trimmer

Eliminates hand filing of laminates that normally follows trimming. These specially designed tools will flush trim the laminate and break the sharp edge all in one pass.

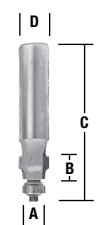

Carbide-Tipped Ball Bearing Pilot

A	B	C	D	Part #
1/2	3/8	1-7/8	1/4	733327-A

7° Bevel Trimmer - Self-Piloting

For 7° bevel edging on plastic laminates. Small diameter allows intricate and close quarter cuts. No router guides are necessary.

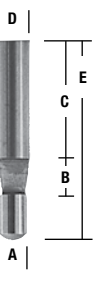

Solid Carbide

A	B	C	D	E	Part #
3/16	1/4	1-1/16	1/4	1-1/2	733128-2A
1/2	9/32	1	1/4	1-7/8	733128-3A

BASES / SUB BASES / DUST NOZZLE

Description	Model	Part #
Standard Base Assembly		193103-8
D-Handle Base Assembly		193104-6
Plunge Base Assembly	RD1101, RF1101, RP1101	193457-3
1" Sub Base		193373-9*
2-1/2" Clear Sub Base		193155-9
Plunge Base Assembly		196094-2
Tilt Base	RT0700C, RT0701C, XTR01	198987-9
Offset Base		196093-4
Fixed Base Handles	RT0700C, RT0701C, XTR01	196924-7

*Accepts 2-pc. Template Guides

Description	Model	Part #
Tilt Base	3700B, 3708FC	122390-2, 153351-1
Fixed Base	3707FC, 3708FC	417748-1
Trimmer Shoe	3700B	155263-4
Trimmer Guide	RT0700C, RT0701C, XTR01	122703-7

TEMPLATE GUIDES & ADAPTER

Description	Size A	Size B	Size C	Model	Part #
2-Pc. Template Guide					
Template Guide	57/64	1	7/16	3606*, 3621*, 3707FC, 3708FC, RD1101, RF1101, RP1101, RT0700C, RT0701C, XTR01	193235-1, 193261-0, 193262-8, 193263-6, 193264-4, 193265-2, 193266-0, 193366-6
Template Guide Nut sold separately *Use with corresponding Template Guide Adaptor					

Description	Part #
Template Guide Nut (Use with above Template Guides)	252627-4

Description	Size A	Size B	Size C	Model	Part #
1-Pc. Template Guide Adapter					
Template Guide Adapter	1-3/16	1-3/8	9/32	3612, 3612C, 3621, 3707FC, 3708FC, RP1800, RP0900, RP2301FC	321492-3

Size A	Size B	Size C	Model	Part #
1-Pc. Template Guide				
19/64	3/8	29/64	3606, 3612, 3612C, 3621, RP0900K,	164379-4, 164775-6, 164776-4,
23/64	7/16	33/64	3612C, 3621, RP0900K,	164835-4,
7/16	1/2	33/64	RP2301FC,	164393-0,
9/16	5/8	33/64	RT0700CX3	164470-8
45/64	25/32	33/64		
15/16	1-1/16	33/64		

PORTABLE TRIPOD LIGHT STAND

Description	Model	Part #
Portable Tripod Light Stand	DML805	GM00001381

Flood Light sold separately

- Durable, lightweight metal construction for long life and easy portability
- Includes attachment for utilizing two lights
- Sturdy three legged design for maximum stability
- Tripod telescopes to 58"
- Collapsible design for optimal portability

GUIDES / HOLDERS

Description	Model	Part #
Straight Guide	RD1101, RF1101, RP1101	193073-1
	3606	123058-3
	3621, RP0900K, RT0701C	164834-6
	3612/C, RP1800, RP2301FC	342428-9*
	3709, RT0700C	122704-5
	3601B	123029-0
Guide Holder	RP1800, RP2301FC	122700-3
Guide Holder Set	RT0700C	195564-8
Trimmer Guide	3612/C, RP1800, RP2301	123022-4*
Trimmer Guide Assembly	RP0900K	STEX122385
Router Guide	RP2301FC, RP1800, RD1101, RP0900K, 3606, RT0700CX3	194579-2
Guide Rail: 39" 55" 118"	Use with 194579-2	194140-0, 199368-5, 194367-7
Guide Rail Adapter	Use with 4100K	198673-2
Clamp Set	Use with 194368-5 and 194367-6	194385-5
Protective Guide Rail Bag: 39" 57-1/2"	-	B-66905, B-57613

*For use with corresponding guide holder

COLLETS

Description	Diameter	Model	Part #
Collet w/Nut	1/4"	RD1101	193214-9
Collet only	1/2"	3601B	763623-2
Collet only	1/2"	RF1101	763643-6
Nut only (For use with 1/2" Collet)		RP1101	763642-8
Collet Cone	1/8"	XOC01	763677-9
	1/4"	3621, RP0900K, RT0700C, RT0701C, XTR01	763637-1
	1/4"	3606, 3700B, 3707FC, 3708FC	763608-8
	3/8"	RT0700C, RT0701C, XTR01	763619-3
	1/2"	3601B	763623-2
	1/2"	3612/C, RP1800, RP2301FC	763622-4
Collet Sleeve	1/4" (I.D.)	3612/C, RD1101, RF1101, RP1800, RP2301FC	763803-0
	3/8" (I.D.)	RP1101	763805-6
	1/2" (O.D.)	RP1101	763805-6

VACUUM ADAPTERS

Description	Model	Part #
Adapter For connection to vacuum hose	RD1101, RF1101/KIT, RP1101	193379-7
	RP0900K, RT0700CX3, RT0701CX3	194733-8
	RT0700C, RT0701C, XTR01	195559-1
	RP2301FC, RP1800	P-80023
	3606, 3612/C, 3621	192035-6

INTERLOCKING CASES

SMARTER FEATURES Convenient. Customizable.

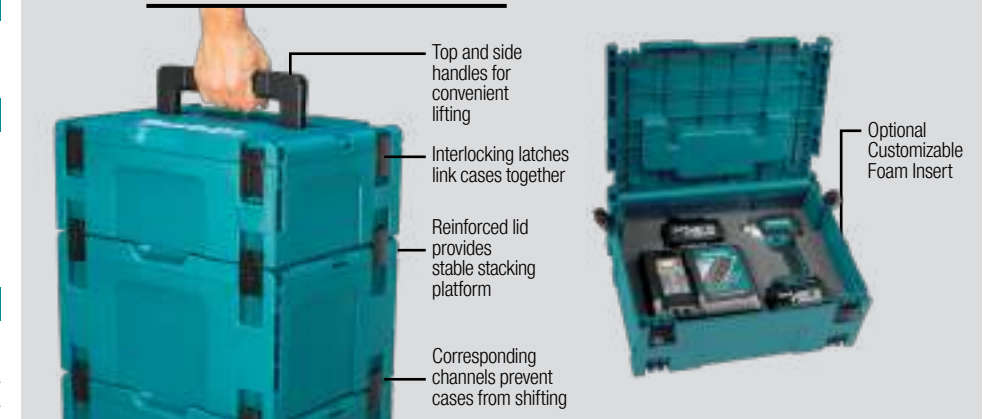



Description	Size	Part #
W	4-3/8"x15-1/2"x11-5/8"	197210-9
Medium	6-1/2"x15-1/2"x11-5/8"	197211-7
Large	8-1/2"x15-1/2"x11-5/8"	197212-5
X-Large	12-1/2"x15-1/2"x11-5/8"	197213-3
Insulated Cooler Box	8-1/2" x 15-1/2" x 11-5/8"	198276-2
Foam Insert	2-1/2"x15-1/8"x11-1/4"	T-02571
Replacement Latch	-	453974-8

TOOL BAGS

Description	Model	Part #
Tool Bag	XT250, XT32814, XSH01X, XSR01PT	831271-6
Tool Bag	LCT200W, LCT300W, LCT400W, CT225R, CT320R, CX200RB	831274-0
Tool Bag	XT405, XT406, XT407, XT440, XT442	831284-7
Tool Bag with Wheels	LXT601, LXT702, LXT902, LXT1500, XT610, XT704, XT902, XT1501	831269-3
14" Contractor Tool Bag		831253-8
21" Contractor Tool Bag		831303-9

MULTI-TOOL ACCESSORIES

Description	Part #
 <p>3-1/4" Round Saw Blade A-95168 BiM-TiN Titanium nitride (TiN) coated teeth for increased performance and improved durability Applications:</p> <ul style="list-style-type: none"> Plunge cutting in drywall, plasterboard (installing electrical outlets) Cutting crownmolding, case & base, wood flooring, wood trim 	
 <p>3-1/4" Segmented Saw Blade A-95227 High carbon steel (HCS) for more aggressive cutting Applications:</p> <ul style="list-style-type: none"> Plunge cutting in soft and hard woods (installing vents on wood floors) Flush cutting wood (case and base) Cutting off plastic pipe (PVC) to length 	
 <p>1-1/4" Plunge Blade A-95255 Bi-metal (BiM) construction for increased performance and improved durability Japanese tooth style for improved flush cutting Applications:</p> <ul style="list-style-type: none"> Plunge cutting in soft and hard woods (installing vents on wood floors) Flush cutting wood (case and base) Flush cutting wooden components (cutting dowels and tenons to length) 	
 <p>1-1/4" Plunge Blade A-95277 High carbon steel (HCS) for more aggressive cutting Applications:</p> <ul style="list-style-type: none"> Plunge cutting in soft and hard woods (installing vents on wood floors) Flush cutting wood (case and base) Flush cutting wooden components (cutting dowels and tenons to length) 	
 <p>2" Scraper A-95342 High carbon steel (HCS) for more aggressive applications Applications:</p> <ul style="list-style-type: none"> Removing soft carpet adhesive residues Removing paint residues Removing silicone joints from glass windows and doors 	
 <p>3-1/4" Grout Removal Blade A-95386 Tungsten carbide 30 grit for aggressive material removal TC grit for increased performance and improved durability Applications:</p> <ul style="list-style-type: none"> Routing joints on walls and floor tiles Smaller cutouts in soft wall tiles 	
 <p>3" Scraping Plate A-95401 Tungsten carbide 30 grit for aggressive material removal TC grit for increased performance and improved durability Applications:</p> <ul style="list-style-type: none"> Removing mortar or tile adhesive (e.g. when replacing damaged tiles) Removing carpet adhesive residues from a mineral surface 	

Description	Part #
 <p>Adapter 196271-6 • Fits most Fein® and other competitive multi-tool accessories</p>	
 <p>Adapter 313249-6 • Fits Dremel® and Bosch® accessories Fein® is a registered trademark of C. & E. Fein GmbH Dremel® & Bosch® are registered trademarks of Robert Bosch Tool Corporation</p>	

Description	Part #
 <p>Sanding Pad A-96089 6-hole design engineered for increased dust extraction Multi-purpose sanding pad to be used with hook-and-loop sandpaper Applications:</p> <ul style="list-style-type: none"> Detail sanding and hard to reach areas Paint removal on wood and metal surfaces 	

Grit	Qty.	Part #
#80	10	A-95526
#100	10	A-95744
#120	10	A-95532
#150	10	A-95750
#180	10	A-95548
Assortment Pack 2 ea.: #80, #100, #120, #150, #180	10	A-95853

Sandpaper
High-quality aluminum oxide grain
Open-coat grain distribution and resin glue coating reduces grain clogging and improves finish on wood surfaces
6-hole design engineered for increased dust extraction
Applications:

- Sanding on hardwood, softwood and other building materials
- Ideal for use on bare wood, paint, varnish, fillers, plastic and other materials

Description	Model	Part #
Dust Extraction		
Dust extracting attachment	TM3010C	196550-2
Dust extracting attachment	LXMT02	195965-0
Dust extracting attachment	XMT03	196765-1

HOOK AND LOOP ABRASIVE PAPER

Grit	Model	5/Pkg. Part #
#60		742529-7
#80		742520-A
#100		742530-2
#150	B04551	742531-0
#240		742521-A
#320		742528-A
Assortment		742529-7-A

Grit	Model	5/Pkg. Part #
#60		794566-7
#80		794567-5
#120	B03710	794568-3
#180		794569-1

Grit	Model	5/Pkg. Part #	50/Pkg. Part #
#40		742137-A	742137-A-50
#60		794518-8	794518-8-50
#80		794519-6	794519-6-50
#100	B05030/K, B05031K, B05041K, X0B01	794523-A	794523-A-50
#120		794520-1	794520-1-50
#180		794521-9	794521-9-50
#240		794522-7	794522-7-50
#320		742526-A	742526-A-50
#400		742527-A	742527-A-50

Grit	Model	10/Pkg. Part #
#40		794607-9
#60		794608-7
#80	B05060J, B06030, B06040	794609-5
#120		794610-0
#180		794611-8
#240		794612-6

ABRASIVE PAPER

4-1/2" x 5-1/2" Sheets



Grit	Model	5/Pkg. Part #	10/Pkg. Part #
#60	B04556/K	742509-3-5	
#80		742523-9-5	
#100		742510-8-5	
#150		742511-6-5	
#180		742512-A-5	742512-A
#240		742513-A-5	742513-A

PSA (PRESSURE SENSITIVE ADHESIVE) PAPER

5" Round Disc

Use with Pad #743056-7



Grit	Model	Qty.	Part #
#60	B05030/K, B05031K, B05041K	5	742131-A
#80		5	742132-A
#80		50	742132-A-50
#100		5	742133-A
#120		5	742134-A
#180		5	742135-A
#240	5	742136-A	

PSA (PRESSURE SENSITIVE ADHESIVE) DISCS

5" Round Disc

Use with Pad #743031-3



Grit	Model	5/Pkg. Part #
#60	B04530	742095-4
#80		742095-8A
#100		742096-2
#120		742096-6A
#150		742097-0
#180		742097-7A

6" Round Disc

Use with Pad #743032-1



Grit	Model	5/Pkg. Part #
#60	B04530	742098-8
#100		742099-6
#120		742101-5
#150		742100-7
#180		742102-3

REPLACEMENT PADS

Hook & Loop Backing Pad

Use with Hook & Loop abrasive paper



Size	Type	Model	Part #
4-1/2" x 9"	General Purpose	B04900V	193522-8
5" Round	Flat Sanding	B05030/K, B05031K,	743081-8
5" Round	Contour Sanding	B05041K, X0B01	743022-A
6" Round	General Purpose	B05060J, B06030,	A-91207
6" Round	Flat Sanding	B06040,	A-91198

4-3/8" x 4" Backing Pad



Type	Model	Part #
Finishing	B04556K	158324-9

Pressure Sensitive Pad

Use with PSA (Self Adhesive)



Size	Model	Part #
5" Round	B05030/K, B05031K, B05041K	743031-3
6" Round		743032-1
4" x 4-3/8"		743030-5
5" Round		743056-7

ABRASIVE BELTS

3/8" x 21"



Size	Grit	Model	10/Pkg. Part #
3/8" x 21"	#40	9032	A-34447
	#60		A-34453
	#80		A-34469
	#100		A-34475
	#120		A-34481

1/2" x 21"



Size	Grit	Model	10/Pkg. Part #
1/2" x 21"	#40	9032	A-34562
	#60		A-34578
	#80		A-34584
	#100		A-34590
	#120		A-34609

1-1/8" x 21"



Size	Grit	Model	10/Pkg. Part #
1-1/8" x 21"	#40	9031	742301-7
	#60		742302-5
	#80		742303-3
	#100		742304-1
	#120		742305-9
	#150		742334-2
	#180		742336-A
	#220		742337-A
	#240		742335-A

- General-purpose aluminum-oxide construction
- For wood, plastics, resins and metals

Arm Assembly



Size	Model	Part #
1/4"	9032	125157-7
3/8"		125158-5
1/2"		125159-3

3" x 18"



Grit	Model	2/Pkg. Part #	10/Pkg. Part #
#40	9910, 9911	794552-A-2	794552-A
#60		794553-A-2	794553-A
#80		794551-A-2	794551-A
#100		794554-A-2	794554-A
#120		742313-A-2	742313-A

3" x 21"



Grit	Model	2/Pkg. Part #	10/Pkg. Part #
#40	9901, 9903	794119-F-2	742306-7
#60		794119-A-2	742307-5
#80		794119-B-2	742308-3
#100		794119-C-2	742309-1
#120		794119-D-2	742310-6
#150		794119-E-2	742311-4

3" x 24"



Grit	Model	2/Pkg. Part #	10/Pkg. Part #
#40	9920, 9924DB	794237-A-2	742312-8A
#60		794237-B-2	742312-8B
#80		794237-C-2	742312-8C
#100		794237-D-2	742312-8D
#120		794237-E-2	742312-8E
#150		794237-F-2	742312-8F

4" x 24"



Grit	Model	2/Pkg. Part #	10/Pkg. Part #
#40	9403, 9404	794133-A-2	742320-3
#60		794133-B-2	742321-1
#80		794133-C-2	742322-9
#100		794133-D-2	742323-7
#120		794133-E-2	742324-5
#150		794133-F-2	742325-3

- High-quality aluminum-oxide grain abrasive for increased durability and sharpness
- Open-coat grain distribution and resin glue coating reduces grain clogging and improves finish on wood surfaces
- Heavyweight backing reduces edge tear-out for more sanding
- Ideal for quick removal of material on large sections of wood and metal

WHEEL SANDER ACCESSORIES

Wheels

Designed for many applications



Description	Model	Part #
Slit paper for sanding (#40 Grit)	9741	794380-1
Wire brush for metal finishing		794382-7
#80 Grit - Coarse		794384-3
#100 Grit - Medium		794379-6
#240 Grit - Fine		794383-5

Nylon Brush Wheels

Removes rust



AUTHORIZED MAKITA® DISTRIBUTORS

Makita® tools are sold through authorized Makita® distributors. They are established throughout the United States with well-balanced inventories to assure you fast delivery; and are staffed with experienced personnel to assist you in selecting the proper tools for your specific requirements.

LISTED

Any Makita® tool that bears the UL or CSAus mark has been evaluated by Underwriters Laboratories, Inc. or the Canadian Standards Association, (NRTL approved) to meet the OSHA requirements.



TRADE ASSOCIATIONS

Makita® U.S.A., Inc., is an associate member of the following trade and standards associations:



INSTRUCTION MANUAL

For your safety and best optimum tool performance, be sure to read, understand, and follow all the safety and operating procedures listed in the instruction manual before connecting your tool to a power source. An instruction manual is furnished with every Makita® tool. If yours is lost, stay safe! Contact the nearest Makita® Sales Office/Distribution Center for a replacement, or visit makitatools.com.

DOUBLE INSULATION

Most Makita® tools do not require 3-prong "grounded" plugs because they are "DOUBLE INSULATED". Double insulated tools protect the user by two independent insulation systems. These systems shield the electric motor components from the outer motor housing and gripping areas of the tools. All Double Insulated Makita® power tools are denoted by the double square safety mark.

UNITS OF MEASUREMENT

Amp Hour: (Ah) The standard measure of capacity for a rechargeable battery. The quantity of electricity that passes through a circuit in one hour when the rate of flow is one ampere.

Watt Hour: The practical unit of energy capacity. Equal to the battery voltage multiplied by the amp hours of that battery.

Maximum Watts Out: An accurate unit measurement of power from an electric motor. One watt equals the amount of power required to maintain a current of one ampere at a pressure of one volt.

Vibration: (m/s²) measurements are made in the direction of feed force and with three axes of a basicentric co-ordinate system. Measurements shall be carried out at a point halfway along the length of the handles or where an operator normally holds the tool. If the placing of the switch actuator makes this impossible then the accelerometer is placed as close as possible to the hand between the thumb and the index finger.

Joules: (J) The basic unit measuring impact energy. Equal to the amount of work done by force of one Newton acting through a distance of one meter in the direction of the force.

Newton Meters: (N•m) A unit of the meter-kilogram-second system equal to the energy expended, or work done, by a force of one newton acting through a distance of one meter and equal to one joule. N•m → ft. lbs., multiply by .7380.

EPTA Standard for Stated Net Weight Values: Makita® Industrial Power Tools are weighed in accordance to standards set by the European Power Tool Association (EPTA). In catalogs, the attribute is designated as weight without the cord, and for cordless products as weight including batteries, unless otherwise noted.

COMMON ABBREVIATED TERMS

The following abbreviations are used throughout this catalog:

Ah —Amp per hours	N•m —Newton•meters	RPM —Revolutions Per Minute
BPM —Blows Per Minute	Ni-Cd —Nickel Cadmium	SFPM —Surface Feet Per Minute
CFM —Cubic Feet per Minute	Ni-MH —Nickel Metal-Hydride	SPM —Strokes Per Minute
FPS —Feet Per Second	OPM —Orbits Per Minute	TPI —Teeth Per Inch
IPM —Impacts Per Minute	Pkg. —Package	VAC —Volts Alternating Current
Li-Ion —Lithium-Ion	Qty. —Quantity	VDC —Volts Direct Current

TRADEMARKS

The following are trademarks for Makita® Power Tools and Accessories:

Advanced Directional Air Flow™	Interna-Lok™	Rocket 6000™
Automatic Speed Change™	Impact X™	Sidewinder™
AVT®	LXT® Lithium-Ion	Stubby Finder/Driver™
Advanced AVT®	LXT® Brushless Lithium-Ion	SJS® - Super Joint System
AWS™ Auto-Start Wireless System	Makita®	SJSII™
BlueMaks™	Makstar™	Thruster®
CXT® Lithium-Ion	Maximum Cordless™	UltraFast®
CXT® Brushless Lithium-Ion	MForce™-SL	UltraLok™
Demolisher™	MM2™ - Makita® Mini 2-Stroke Engine	Vision Finder/Driver™
DXT®	MM4™ - Makita® Mini-4-Stroke Engine	The MAKITA Logo™
eLuminate™	More Power. Less Weight. Better Engineering®	18V POWER, 12V WEIGHT.™
Finder/Driver™	Oil Impulse™	XPT™ - Extreme Protection Technology
HP® - High Pressure	Push Drive™	XtractVac®
Impact GOLD®	Quick-Shift Mode™	

SYMBOLS USED IN THIS CATALOG

	7.2V Lithium-Ion		Interna-Lok™
	12V max Lithium-Ion		Laser
	36V Lithium-Ion		Laser Radiation – Caution
	Accepts 1-1/8" Hex		L.E.D.
	Accepts 3/4" Hex - 21/32" Round		LXT® Lithium-Ion
	Accepts Makita small		LXT® Lithium-Ion Brushless
	Accepts SDS-MAX		LXT® Lithium-Ion Compact
	Accepts SDS-PLUS		LXT® Lithium-Ion Compact Brushless
	Accepts Spline shank		LXT® Lithium-Ion Sub-Compact
	AC/DC		LXT® Lithium-Ion Sub-Compact Brushless
	Advanced Directional Air Flow™		Magnesium™
	2.0Ah BATTERY		Makita®
	3.0Ah BATTERY		MM4® - Makita® Mini 4-Stroke Engine
	4.0Ah BATTERY		Mossy Oak® Breakup Infinity
	5.0Ah BATTERY		Nailer Degrees: 15°, 21°
	6.0Ah BATTERY		New Product
	AMP – 11 AMP, 12 AMP, 13 AMP, 15 AMP		Oil Impulse™
			Pneumatics
			Push Drive™
			Quick-Shift Mode™
	Automatic Speed Change™		Ridgeline™
	Advanced AVT™		Sidewinder® Angle Drills
	AVT® - Anti-Vibration Technology		SJS® - Super Joint System
	AWS™ - Auto-Start Wireless System		SJSII™
	Big Bore™		Sync Lock™
	Bluetooth®		Tool-Less Chain Adjustment
	CXT® Lithium-Ion		Thruster® SDS-PLUS Rotary Bit
	CXT® Lithium-Ion Brushless		Thruster® Percussion
	Demolisher™ Recipro Blades		UltraFast®
	DXT® Deep and eXact Cutting Technology		USB Compatible Device
	Easy Start - Easy Starting System		X2 LXT® (36V) Lithium-Ion
	Electric Brake		X2 LXT® Lithium-Ion Brushless
	Gauge – 16, 18		XPT™ - Extreme Protection Technology
			Xtract Vac®
	HDF - Heavy-Duty Filter		Z-Tool Available
	HEPA		
	Heated Handle		
	High Pressure® Technology		
	Hook & Loop		
	Hybrid 4 Function		
	Impact GOLD®		
	Impact X™		
	Includes Battery, Charger, Tool Case, Tool Bag		

The Makita® TEAL COLOR is the trade dress of Makita Corporation and is protected under common law and registered with the U.S. Patent and Trademark Office. The Makita® Black & White color combination is the trade dress of Makita Corporation and is protected under common law and registered with the U.S. Patent and Trademark Office.



SAFETY PRECAUTIONS

Read, understand and follow all instructions and warnings in tool or charger instruction manual as well as those provided with recommended accessories.

Keep guards in place and in working order.
Use recommended accessories only.

Check damaged parts. (Before further use of the tool, a guard or other part that is damaged should be carefully checked to determine that it will operate properly and perform its intended function). A guard or other part that is damaged should be properly repaired or replaced by an authorized service center.

Keep work area clean. Cluttered areas and benches invite injuries. Consider work area environment. Do not use power tools in damp or wet locations. Keep work area well lit. Do not expose power tools to rain. Do not use tools or chargers in presence of flammable liquids or gases.

Keep children away. All visitors should be kept away from work area.

Store idle tools. When not in use, tools should be stored high or locked up out of reach of children.

Use the right tool. Do not force a small tool or attachment to do the job of a heavy duty tool. Do not use tool or accessories for purpose not intended. Only use proper, recommended accessories for the tool being used. Only use genuine Makita® batteries and chargers

Dress properly. Do not wear loose clothing or jewelry. They can be caught in moving parts. Wear protective hair covering to contain long hair.

Use safety glasses whenever operating any tool. Makita® safety goggles and glasses are available (part no. 191686-2, 191684-A and 191685-A). Also use face or dust mask if operation is dusty.

Don't abuse cord. Never carry tool by cord or yank it to disconnect from receptacle.

Secure work. Use clamps or a vise to hold workpiece. It can be safer and it frees both hands to operate and control tool.

Maintain tools with care. Keep tools sharp and clean for best and safest performance. Follow instructions for lubrication and changing accessories.

Unplug tools. When not in use, before servicing, and when changing accessories. Remove adjusting keys and wrenches. Form a habit of checking to see that keys and adjusting wrenches are removed from tool before turning it on.

Avoid unintentional starting. Don't carry plugged-in tool with finger on switch. Be sure switch is OFF when plugging in.

Outdoor use extension cords. When tool is used outdoors, use only extension cords intended for use outdoors and so marked.

Guard against electric shock. Prevent body contact with grounded surfaces. For example: pipes, radiators, ranges and refrigerator enclosures.

Replacement parts. When servicing, use only genuine Makita® replacement parts.

Never leave tool running unattended. Turn power off. Don't leave tool until it comes to a complete stop.

LIMITED WARRANTY

MAKITA® 30 DAY RETURN / REPLACEMENT GUARANTEE

Every Makita® product is thoroughly inspected and tested before leaving the factory. If you are not satisfied with any Makita® product within 30 days of purchase, return it and Makita® will provide, at Makita's option, a replacement or refund. This guarantee does not apply to Makita® Accessories and/or wearable items such as bits, blades or cutters.

MAKITA® GENERAL PRODUCT LIMITED WARRANTY

Every Makita® product is warranted to be free of defects from workmanship and materials for the period of ONE YEAR from the date of original purchase. Certain products referenced below have longer warranties. Should any trouble develop during the one-year period, return the COMPLETE product, freight prepaid by user, to one of Makita's Factory or Authorized Service Centers. If inspection shows the trouble is caused by defective workmanship or material, Makita® will repair (or at our option, replace) without charge.



*See below for limitations and exclusions applicable to all Makita® warranties

MAKITA® 3-YEAR LIMITED WARRANTY, PNEUMATIC NAILER, LITHIUM-ION TOOL, BATTERY AND CHARGER

Every Makita® Pneumatic Nailer and Lithium-Ion Tool, Battery and Charger is warranted to be free of defects from workmanship and materials for the period of THREE YEARS from the date of original purchase. Should any trouble develop during the three-year period, return the COMPLETE Lithium-Ion Tool, Battery, Charger or Pneumatic Nailer, freight prepaid by user, to one of Makita's Factory or Authorized Service Centers. If inspection shows the trouble is caused by defective workmanship or material, Makita® will repair (or at our option, replace) without charge.



*See below for limitations and exclusions applicable to all Makita® warranties

MAKITA® WARRANTY LIMITATIONS AND EXCLUSIONS

These warranties do not apply to Makita® Accessories or where:

- Repairs have been made or attempted by others
- Repairs are required because of normal wear and tear. With regard to Pneumatic Nailers, normal wear parts include the following and are not covered under this warranty: piston/driver assemblies, piston stops, driver blades, rubber o-rings, seals, isolators, air filters, and driver belts.
- The tool has been abused, misused, improperly maintained or operated. With regard to Pneumatic Nailers, improper operation includes the failure to use clean, dry regulated compressed air and/or air pressures exceeding the maximum indicated on the nailer casting. With regard to Lithium-Ion Tools, improper operation includes the use of a non-genuine or "knock-off" battery on a Lithium-Ion Tool or Charger. With regard to Laser Instruments, abuse includes liquid damage or physical damage caused by impact.
- Alterations have been made to the tool

IN NO EVENT SHALL MAKITA® BE LIABLE FOR (A) ANY INDIRECT, INCIDENTAL, PUNITIVE OR CONSEQUENTIAL DAMAGES ARISING FROM THE SALE OR USE OF THE PRODUCTS SOLD UNDER THESE WARRANTIES, OR (B) ANY AMOUNT IN EXCESS OF THE AMOUNT ACTUALLY PAID TO MAKITA® FOR THE PRODUCTS SOLD HEREUNDER. THIS LIMITATION APPLIES BOTH DURING AND AFTER THE TERMS OF THE WARRANTY.

MAKITA® DISCLAIMS LIABILITY FOR ANY IMPLIED WARRANTIES, INCLUDING IMPLIED WARRANTIES OF "MERCHANTABILITY" AND "FITNESS FOR A SPECIFIC PURPOSE" AFTER THE EXPIRATION OF ANY EXPRESS WARRANTY.

This warranty gives you specific legal rights, and you may also have other rights which vary from state to state. Some states do not allow the exclusion or limitation of incidental or consequential damages, so the above limitation or exclusion may not apply to you. Some states do not allow limitation on how long an implied warranty lasts, so the above limitation may not apply to you.

DISCLAIMER

Makita® U.S.A., Inc., reserves the right to make changes or improvements on its products without incurring an additional obligation including any obligation to make corresponding changes or improvements to products previously manufactured or sold. Makita® reserves the right to discontinue products at any time without notice. All illustrations and photographs displayed in this catalog are the property of Makita® U.S.A., Inc., and shall not be duplicated or reproduced without the express written consent of Makita® U.S.A., Inc.

CONTACT MAKITA®

1-800-4MAKITA

1-800-462-5482
makitatools.com

“KNOCK-OFF” MAKITA® LITHIUM-ION BATTERIES MAY BURST CAUSING FIRES, PERSONAL INJURIES OR PROPERTY DAMAGE

⚠ CAUTION MAKITA® U.S.A., INC. NOTIFIES TOOL USERS OF THE HAZARDS AND RISKS OF USING NON-GENUINE (“KNOCK-OFF”) MAKITA® LITHIUM-ION BATTERIES.

Makita® Lithium-Ion batteries are manufactured to strict standards, and are engineered with internal electronic circuitry to monitor the battery conditions when in use with Makita® tools and chargers. By using a non-genuine Makita® “knock-off” battery or batteries that have been altered, the sophisticated electronic communication system between the battery and charger as well as between the battery and the tool may be defeated. This will result in:

- Voiding the Makita® Warranty for the Makita® tool and charger
- Voiding the UL/CSA Standards approval of the tool

When using non-genuine Makita® batteries, there is also a risk of:

- The battery bursting that may result in personal injury and/or property damage
- Possible fire damage to the tool, the battery and/or the charger
- Unknown tool performance

Makita® bears no liability for accidents, personal injury or property damage (or damage to batteries, tools or chargers) that occurs as a result of the use of “knock-off” batteries, or batteries that have been repaired or altered in any way.

Don't be fooled! Genuine Makita® batteries are black in color, have the Makita® trademark logo with Lithium-Ion identification on both sides, and have the Makita® trademark logo on the bottom of the battery. “Knock-off” batteries may appear to be similar to genuine Makita® batteries but have no Makita® branding on them. Makita® only approves the use of genuine parts and accessories with Makita® tools. Makita® does not approve the use of non-genuine or “knock-off” Lithium-Ion batteries which are marketed and sold by third parties for use in Makita® Lithium-Ion cordless tools.



IF THERE IS ANY QUESTION WHETHER YOUR BATTERY IS A GENUINE MAKITA® PRODUCT, OR IF YOU HAVE A PERFORMANCE ISSUE WITH YOUR MAKITA® BATTERY, TOOL, OR CHARGER, CONTACT A MAKITA® FACTORY SERVICE CENTER OR AUTHORIZED SERVICE CENTER, OR CALL (800)4-MAKITA.



DRIVING INNOVATION TOUR™

LEARN MORE
MAKITATOOLS.COM/DRIVINGINNOVATION

DRIVING INNOVATION TOUR™

The Driving Innovation Tour™ is an interactive tool demonstration on wheels. The Makita® fleet of fully-custom vehicles is traveling across America, bringing users ONE SYSTEM and the world's largest 18V lithium-ion cordless tool system. Each Tour event features over 100 LXT tools and power equipment with interactive displays and hands-on demonstrations focusing on construction trades, dust management, landscaping, and more. Driving Innovation delivers high-energy events and a 360-degree experience with the very latest in cordless innovation as well as sweepstakes, giveaways, and sales promotions. Experience the Makita® Advantage at a Driving Innovation Tour™ event.

DRIVING INNOVATION TOUR FINDER



Use our Tour Finder and search where you can experience the Makita® Advantage at a Driving Innovation Tour Event.

FACTORY SERVICE CENTERS

Makita® manufactures best-in-class industrial power tools for the professional user. Our tools work hard and stand up to brutal working conditions, but last even longer with periodic service and repairs. That's why we offer a comprehensive national service network. **Makita® Factory Service Centers** deliver world-class service for the complete care of all Makita® products. We are also proud to offer a coast to coast network of **Authorized Service Centers**. Makita® Authorized Service Centers meet our high-quality standards and provide the same distinguished service experienced at any of our Makita® Factory Service Centers.

MAKITA® FACTORY SERVICE CENTERS



QUALITY SERVICE

- Factory trained repair technicians
- Genuine Makita® replacement parts
- Safety Certification Check performed on all electric power tools
- Maximum cost repair program



FAST REPAIR TIME

- Most tools repaired within two working days



FREE

- Repair estimates
- Labor for qualified trade schools
- Pick-up and delivery (select markets)



CALIFORNIA

3226 Arden Rd.
Hayward, CA 94545

14930 Northam St.
La Mirada, CA 90638

COLORADO

5855 Stapleton Drive North, Unit A-160
Denver, CO 80216

FLORIDA

2101 NW 33rd St., #800A
Pompano Beach, FL 33069-1061

GEORGIA

2660 Buford Highway
Buford, GA 30518

ILLINOIS

1450 Feehanville Dr.
Mt. Prospect, IL 60056

MASSACHUSETTS

346 Vanderbilt Avenue
Norwood, MA 02062

NEW JERSEY

1075 Cranbury South River Rd., Suite. 3
Jamesburg, NJ 08831

NEVADA

5720 South Arville St., STE. 114
Las Vegas, NV 89118

OREGON

4908 Northeast 122nd Ave.
Portland, OR 97230

TEXAS

13370 Branchview Lane, Suite 125
Farmers Branch, TX 75234-5773

5219 Langfield Rd.
Houston, TX 77040

Locate a Makita® Factory Service Center or an Authorized Service Center



makitatools.com/service

ONLINE PRODUCT REGISTRATION



Register all your Makita® products and keep them in one safe place; your own online Tool Box. It's where you can go to obtain your tool model numbers and serial numbers in the event your tool is stolen or needs service.



REGISTER YOUR PRODUCTS ONLINE
makitatools.com/productregistration

ONLINE PARTS & ENVIRONMENTAL RESPONSIBILITY

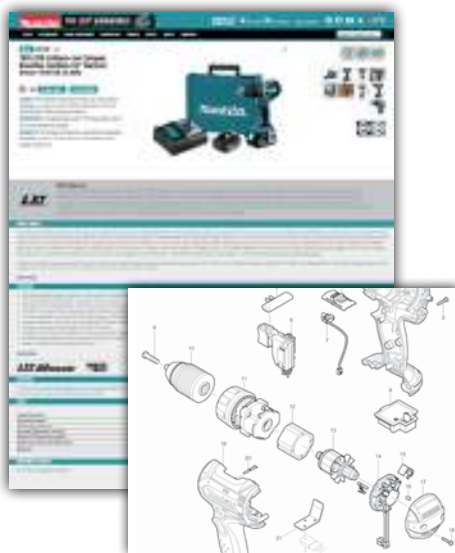

Battery Recycling

Makita® is continuing our sustainability efforts and support for the environment by responsibly recycling rechargeable batteries through the call2recycle® program. The program is no-cost, no-hassle and available at Makita® Service Centers. call2recycle® follows the strictest standards in safety and compliance, including being the first program of its kind to receive Responsible Recycling (R2) certification and e-Steward recognition from the Basel Action Network (BAN).

Go online to makitatools.com, enter the model number in the search field, scroll down the product page to locate the corresponding parts Breakdown and Instruction Manual.

NATIONAL CALL CENTER AND LOCATIONS



For more information or questions regarding Makita® products, parts, accessories or technical assistance, call us at the National Call Center:

1-800-4MAKITA (1-800-462-5482)
 Hours: Monday – Friday 8 a.m. – 6 p.m. (EST)

CORPORATE OFFICE

14930 Northam St.
 La Mirada, CA 90638-5753
 (714) 522-8088 / Fax: (866) 522-8133

MAKITA CORPORATION OF AMERICA

(Manufacturing Facility)
 2650 Buford Hwy.
 Buford, GA 30518
 (770) 932-2901 / Fax: (770) 932-2905

SALES BRANCHES AND DISTRIBUTION CENTERS

Southern Regional Office and Distribution Center

910 E. Pleasant Run Road
 Wilmer, TX 75172-2720
 (972) 441-8101 / Fax: (855) 231-0468

Southeastern Regional Office and Distribution Center

2660 Buford Hwy.
 Buford, GA 30518
 (800) 637-3603 / Fax: (866) 521-3541

Western Regional Office and Distribution Center

14930 Northam St.
 La Mirada, CA 90638
 (714) 522-8088 / Fax: (866) 521-3532

Central Regional Office and Distribution Center

1450 Feehanville Dr.
 Mount Prospect, IL 60056-6011
 (847) 297-3100 / Fax: (866) 521-3532

1 - 5

1002BA	102
1806B	103
1912B	102
2012NB	96
2107FZ	82
2107FZK	82
2414DB	83
2705	96
2705X1	96
3706	72
3706K	72
3709	100
4100KB	60
4100NH	60
4101RH	60
4114	59
4131	83
4329K	92
4350FCT	92
4351FCT	92
5005BA	90
5007F	88
5007FA	88
5007MG	88
5007MGA	88
5007NK	88
5008MGA	88
5057KB	88
5104	91
5377MG	88
5402NA	91
5477NB	89

6 - 9

6302H	68
6407	68
6408	68
6408K	68
6906	72
6922NB	72
6952	72
6953	72
7104L	104
9005B	77
9005BZ	77
9031	101
9032	101
9227C	86
9237C	86
9237CX3	86
9403	102
9404	102
9557NB	74
9557PB	74
9558PB	76
9564CV	74
9564P	74
9564PC	74
9565CV	76
9565PC	77
9565PCV	76
9566CV	77
9566PC	77
9566PCX1	77
9741	102
9903	101
9920	101
9924DB	101
98202	104

A - B

AC001	106
AC310H	106
AD03R1	43

AD04R1	44
AF353	108
AF506	108
AF601	107
AF635	107
AN454	107
AN611	107
AN635H	106
AN902	107
AN924	107
AT638A	108
AT1150A	108
AT2550A	108
BHX2500CA	115
BO3710	101
BO4556	100
BO4556K	100
BO4900V	101
BO5030	100
BO5030K	100
BO5031K	100
BO5041	100
BO5041K	100
BO6030	100
BO6050J	100

C - D

CA5000X	83
CC02R1	45
CF100DZ	47
CJ102DZS	47
CT225R	13
CT226	42
CT226RX	42
CT227R	42
CT320R	12
CT321RX	42
CT323	42
CT324	42
CT409R	42
CT410	42
CX201RB	13
CX202RB	13
CX300RB	12
CX301RB	12
CX303TRB	12
DA3010F	69
DA4000LR	69
DA4031	69
DCF102Z	38
DCF201Z	38
DCF300Z	38
DCJ201Z	40
DCJ205Z	40
DCJ206Z	40
DCL501Z	36, 66
DCM500Z	38
DCV200Z	40
DF012DSE	47
DFJ304Z	40
DFJ405Z	40
DML185	39
DML800	39
DML801	39
DML802	39
DML805	38
DML806	39
DML807	39
DML808	39
DP4000	68
DP4002	68
DRC200PT	36, 66
DS4000	68
DS4011	68

DS4012	68
DT03R1	43
DT04R1	43
DUB182T1	33, 112
DUB183Z	33, 112

E

EA3200SR	118
EA3201SR	118
EA3500SR	118
EA3601FR	118
EA4300FR	118
EA5000PR	118
EA5001PR	118
EA5600FR	119
EA6100PR	119
EA7300PR	119
EA7301PR	119
EA7900PR	119
EA7901PR	119
EB5300TH	115
EB5300WH	115
EB7660TH	115
EB7660WH	115
EE2650H	116
EK6101	59
EK7301	59
EK7651H	58
EK8100	59
EM2650LH	116
EM2650UH	116
EM2652LHN	116
EN4950H	116
EN4951SH	117
EN5950SH	117
EN7350SH	117
EX2650LH	116
EY2650H25H	117

F - G

FD05R1	43
FD06R1	43
FD07R1	43
FS2200	70
FS2500	70
FS2701	70
FS4200	70
FS6200	70
GA4030	74
GA4030K	74
GA4530	74
GA4534	74
GA4542C	75
GA5010Z	77
GA5020	77
GA5020Y	77
GA5040X1	59
GA5042C	76
GA5042CX1	59
GA6010Z	78
GA6010ZX2	78
GA6020	78
GA6020YX1	78
GA7001L	80
GA7011C	78
GA7021	78
GA7031Y	78
GA7040S	79
GA7060	78
GA7061	78
GA7911	80
GA9031Y	79
GA9040S	79
GA9060	79

GC01ZA	44
GC01ZB	44
GC01ZC	44
GD0600	80
GD0601	80
GD0603	80
GD0800C	80
GD0801C	80
GS5000	80
GV5010	81
GV7000C	81

H

HG6031VK	104
HG6530VK	104
HK1810	53
HM0810B	53
HM0870C	53
HM1111C	53
HM1203C	52
HM1211B	53
HM1214C	52
HM1307CB	52
HM1317CB	52
HM1810X3	52
HM1812X3	52
HP1640	57
HP1641K	57
HP2010N	57
HP2050	57
HP2050F	57
HP2070F	57
HR1840	57
HR2475	56
HR2631F	56
HR2641	55
HR2651	56
HR2661	56
HR2811F	54
HR3210C	54
HR4002	54
HR4013C	54
HR4041C	54
HR4510C	53
HR5000	53
HR5212C	53
HS0600	90
HS7600	88
HS7610	88
HU06Z	46

J - K

JN1601	82
JN3201	82
JR3050T	91
JR3070CT	91
JR3070CTH	91
JR3070CTZ	91
JS1300	81
JS1602	81
JS3201	81
JS8000	82
JV0600K	92
KP312	103
KP0800K	102
KP0810	102

L

LC06ZW	47
LC08ZW	46
LC1230	83
LD050P	50
LD080P	50
LS0815F	95



MAX EFFICIENCY

THE NEXT GENERATION OF ACCESSORIES ENGINEERED TO DELIVER OPTIMAL & EFFICIENT CORDED & CORDLESS CUTTING SOLUTIONS



UP TO 70% FASTER CUTTING & 70% MORE CUTS PER CHARGE*

*7-1/4" 24T FRAMING BLADE (B-61656)

6-1/2" 25T
FRAMING BLADE
(B-62963)



10" 80T
CROSSCUTTING BLADE
(B-66977)



12" 100T
CROSSCUTTING BLADE
(B-67000)

