

KESON[®]

MAKE YOUR MARK[®]



PRODUCT CATALOG
VOLUME 21

KESON[®]

MAKE YOUR MARK[®]

Our grandfather and Keson's founder, Roy Nosek, often said:

"If a job is worth doing, it's worth doing right."

We know he didn't say it first, but he said it first to our fathers who said it first to us. He showed us what it means through the way he lived his life and the way he treated people.

Be Positive.

Work Hard.

Respect Others.

Have Fun.

Act Ethically.

Do Good.

Make your mark.



We believe in these principles.

We strive to practice them in all that we do.

Keson products are for people who are passionate about their work and getting it done right.

Aaron Nosek
President

Jude Nosek
Marketing

Dave Nosek
Human Resources

TABLE OF CONTENTS

NEW PRODUCTS FOR 2021

MEASURING

4
6
7
8
10
13
17
18
20
22
24
25
26
27
28
28
32
33
37
38
38
40
41
42
43
44
45
46
46
47
47
48
50
50
50
51
51
52
53
55
56
57
58
59
63
64
65
65
65
65
65
65
66
67
67
68
73

MEASURING WHEELS

SUMMARY
METAL
PLASTIC
PAINT APPLICATORS

LEVELS

OVERVIEW
BOX BEAM
DIGITAL
I-BEAM
SCREED
SHORT

LONG TAPE MEASURES

OPEN CASE STEEL BLADE
CLOSED CASE STEEL BLADE
OPEN CASE FIBERGLASS BLADE
CLOSED CASE FIBERGLASS BLADE

SHORT TAPE MEASURES

SUMMARY
CHROME SERIES
TOGGLE SERIES
ULTRA BRIGHT SERIES
WIDE BLADE SERIES
AUTOMATIC LOCK SERIES
PROFESSIONAL SERIES
MAGNETIC TIP SERIES
ECONOMY SERIES

SPECIALTY MEASURES

KEY CHAIN: 6 FT TAPE
WOOD RULERS
DIAMETER TAPES
POCKET TAPES
POCKET RODS
SURVEYOR'S ROPES
DEPTH GAUGES

MARKING

CHALK LINE REELS

PRECISION
STANDARD
BOLD
GIANT

CHALK

TWINE

PAINT

SPECIALTY MARKING

VALVE PAING
LUMBER CRAYONS
PENCILS
CHINA MARKERS
HALF MOON CHALK
SOAPSTONE

FLAGGING AND BARRICADE TAPE

SPECIALTY TAPES
FLAGS

BLADE MEASURES

INDEX

*"This product is used by many cavers as **the number one measuring tool** for underground survey of caves. We have taken these tapes well over 500 ft underground and have dragged them through some of the worst mud, grit and grime you can imagine. We have gone to the point of completely covering the tape with mud—so much mud you cannot even see the numbers. We just washed the tape in water and it's like new again. Nowhere above ground are you ever going to encounter conditions like what we put these tapes through. You get what you pay for and **Keson tapes are just that indestructible!**"*

Cave Surveyor, Kelly

NEW PRODUCTS FOR 2021



INTRODUCING KESON LEVELS FEATURING SOLA PATENTED TECHNOLOGY!

KESON is thrilled to be partnered with SOLA. Our new line of levels all feature Austrian-made SOLA vials, the most accurate in the world. The majority of our levels feature the FOCUS Vial, which offers a 20% magnification to ensure an accurate reading.



LKTFM
Magnetic Torpedo Level



LKTSF
Plastic Squared Level



LKTPRM
Small Plastic Level



LKTRF
Plastic Rounded Level



LKGOM
GO! Magnetic



LKL3
String Level

MAGNETIC TAPES



PG1835VMAG



PG1825VMAG



PG1816ALVMAG

PG1816ALVMAG	16 ft.	Ft & In - Autolock
PG1825VMAG	25 ft.	Ft & In
PG18M26VMAG	26 ft	Ft/In & Metric
PG1835VMAG	35 ft.	Ft & In

6 FT. KEYCHAIN TAPES



PG18M6KC



PG186KC

PG186KC	6 ft.	Ft/In
PG18M6KC	6ft/2m	Ft/In & Metric

Now Available! 6 foot Keychain tape measures. Feet & Inches and a 2m/6ft metric version as well.

CHALK LINE REELS

Keson has two new MADE IN THE USA chalk line reels.

The new K3XPRO, 3x1 speed chalk reel, comes in a heavy duty ABS/METAL housing, and offers a PRECISION braided string that snaps a pencil thin line. The K3X, 3x1 speed chalk reel, has a heavy duty ABS housing with our STANDARD twisted string. Both feature the Keson BigMouth chalk port for easy fill up and a protected seal.

New to the Giant CLR Series are the G150BOLD and G3X150BOLD reels. Both have 150 feet of the BOLD braided string (same as the popular, smaller P100 reel), which leaves a thick, crisp line. The G150BOLD comes in the heavy duty ABS Little Giant housing, while the G3X150BOLD is in the ergonomically designed G3X housing. Both come with the patented BigMouth fill port that enables convenient loading of chalk and a protected seal.



K3XPRO



K3X



K3X4R



G150BOLD



G3X150BOLD

OPEN HOUSE OPTIONS

Keson has put together a bucket of Keson equipment including Keson hats, chalk line reels, a long tape, and short tapes.

At a reduced price: 30 P100 or 25 K3X CLR's in a reusable bucket. Great for counter display or used at open houses.

Contact your sales representative for ordering information.



P100BKT



K3XBKT



GEAR BUCKET

MEASURING

MEASURING
WHEELS

LONG TAPE
MEASURES

SHORT TAPE
MEASURES

SPECIALTY

LEVELS



MEASURING WHEELS

BEST VALUE AND BIGGEST VARIETY



We work hard to make sure our measuring wheels are **the best in the world**. We are the new standard, leading the industry in the development of wheels with better features and more valuable benefits.

- Our counters are the **sturdiest and the most reliable**. Our wheels are designed to protect the counter, the most valuable component of the wheel.
- With the industry's **strongest frames**, the MP wheels have become the professional's choice.
- **Longest Warranties** — Limited Lifetime Warranty on all but 3 models (2-year limited wheel warranty for MP401E and RRT series).
- **Safety** — All of our large wheels come with a reflector to help keep you safe while you work.

ACCURACY

99.7% accurate on a flat, even track.

MADE IN THE USA

All of our wheels (except the RRT series) are molded, assembled, and tested in Aurora, IL.



VARIETY

MP SERIES Metal Professional Series of high-end durable wheels. We even have Steel Frame Electronic and Decimeter wheels, the only ones of their kind.

RRT SERIES New models with a trigger brake and a counter reset on the pistol grip handle.

RR KESONITE SERIES Our metal/resin compound wheels with the durability and shape memory of molded composite and the weight of metal.

RR SERIES LARGE AND SMALL Original RoadRunner Series of contractor grade, more economically-priced wheels.

PAINT APPLICATORS Various upside down spray paint applicators for any job.

Available in English, 10ths, and Metric.

DESIGN

We listen. We create new products and improve current models based on your feedback and our own expertise. We're continuously improving our products and processes to provide better service.

METAL WHEEL MODEL SUMMARY



MP401E

MP401

MP301

MP415

MP315M

MP201

METAL PROFESSIONAL WHEELS

These Metal Professional (MP) wheels are durable enough to stand up to the harshest field conditions. All feature the industry's best counters with the best counter protection.

FEATURES

- Innovative design — simple, center-line functionality. Great balance.
- Huge numbers make for easy reading. Superior protection and placement of the counter — the metal shelf keeps dirt and debris from coming into contact with the counter (5 digits, up to 99,999).
- Rugged 3/4 inch steel frame — tough enough to handle any terrain.
- Compact fold-down — easily folds in half for storage and portability.

Limited lifetime warranty / MP401E: 2-year limited warranty.

MODEL	UPC 052837	UNITS	DIA.	CIRC.	SPECIAL FEATURE
MP401E	026715	ft., in & ft, 10ths, metric, continous in.	15-1/2 in.	4 ft.	Steel frame, Electronic brain: area add radius, memory and more
MP401	025756	ft.	15-1/2 in.	4 ft.	Best seller!
MP415	026449	ft. & in. & 10ths	15-1/2 in.	4 ft	Solid plastic wheel, dual scale
MP401P	026111	ft.	15-1/2 in.	4 ft	Plastic spoked wheel
MP301	026128	ft.	11-1/2 in.	3 ft	Best seller!
MP315M	027040	m & dm	.318 m	1 m	Solid wheel, metric
MP301M	025763	m	.318 m	1 m	Steel spoked, metric wheel
MP301DM	026265	m & dm	.318 m	1 m	Steel, decimeter
MP201	008315	ft.	7-1/2 in.	2 ft.	Solid molded wheel



RRT6

RRT12

RR30

RR318N

RR182

RR112

RRPA18

RRPA182

PLASTIC MEASURING WHEELS

Innovative wheels make measuring quick and easy. Balanced and lightweight, and extremely durable.

MODEL	UPC 052837	UNITS	DIA.	CIRC.	SPECIAL FEATURE	WARRANTY
RRT6	027422	ft. & in.	6 in.	18 in.	Handle trigger reset and brake	2 Yr. Limited
RRT610	027576	ft. & 10ths	6 in.	18 in.		
RRT6M	027569	m, dm	15.2 cm	45.7 cm		
RRT12	027415	ft. & in.	12 in.	3 ft.	Handle trigger reset and brake	2 Yr. Limited
RRT1210	027460	ft. & 10ths	12 in.	3 ft.		
RRT12M	027477	m, dm	.318 m	1 m		
RR30	026425	ft., in.	11-1/2 in.	3 ft.	Increased strength & weight	Limited Lifetime
RR3010	026524	ft., 10ths	11-1/2 in.	3 ft.		
RR30M	026500	m, dm	.318 m	1 m		
RR40	026463	ft., in.	15-1/2 in.	4 ft.		
RR318N	008506	ft., in.	12-1/2 in.	3 ft.	Best seller!	Limited Lifetime
RR318N-2	008506	ft., in.	12-1/2 in.	3 ft.	No assembly	
RR310	010172	ft., 10ths	12-1/2 in.	3 ft.		
RR3M	010189	m, dm	.318 m	1 m		
RR418	010196	ft., in.	15-1/2 in.	4 ft.	Great for rough terrain	
RR410	010202	ft., 10ths	15-1/2 in.	4 ft.	Great for rough terrain	Limited Lifetime
RR112	020058	ft., in.	4 in.	1 ft.	Best seller!	
RR110	020065	ft., 10ths	4 in.	1 ft.		
RR10M	020072	m, dm	.097 m	.305 m		Limited Lifetime
RR182	010592	ft., in.	4 in.	1 ft.	Dual-wheel stability	
RR102	010608	ft., 10ths	4 in.	1 ft.	Dual-wheel stability	Limited Lifetime
RRPA18	022298	ft. & in.	12 in.	1 ft.	Single wheel & applicator	
RRPA182	020768	ft. & in.	12 in.	1 ft.	Dual wheel & applicator	

All wheels are made in USA except RRT

MP401E

**MP-ELECTRONIC,
1 SKU**

WORLD'S STRONGEST ELECTRONIC MEASURING WHEEL

The MP401E is Keson's only electronic wheel with a steel frame. It is the world's sturdiest electronic measuring wheel and the easiest and most comfortable to use. It will stand up to the harshest conditions.

Our easy-to-read digital counter is in the most protected spot on the wheel. With the handle up, it is nearly impossible for the counter to come into contact with the ground. With the handle down, the roll bar offers solid protection. Counter requires 2 AA batteries (not included).



50% OF ACTUAL SIZE

Backlit 7 Digit LCD display for low-light usage. Up to 99,999 feet, 11 inches or 99,999.9 in tenths and metric.

FEATURES < MP401E

1. Swan-Neck Ergonomic Handle

Our patent-pending "thumb-up" grip ensures less wrist strain and superior control.

2. Reliable Input System: Magnetic Sensors

Dust, dirt and other particles can disrupt a light beam used in competitive units. Our magnetic pick-up avoids these problems.

3. Sealed Counter Encasement

Designed to NEMA Class III standards, our counter housing ensures that it will not be damaged by rain. What's more, you can safely clean the entire wheel with a damp cloth.



MP401E

MPLGCASE

2-year limited warranty.

MODEL	UPC 052837	UNITS	DIA.	CIRC.	SPECIAL FEATURE
MP401E	026715	ft., in. & ft., 10ths, m, dm, continous in.	15-1/2 in.	4 ft.	Steel frame. Electronic brain: area, add radius, memory, and more
MPLGCASE	026876				Carrying case for wheel

MP SERIES

METAL PROFESSIONAL SPOKED WHEELS

**MP-SPOKED,
5 SKUS, 3 SIZES**



ACTUAL SIZE

Our geared Mechanical Clicker Counter features large, bold 3/4-inch numbers

FEATURES < MP SERIES SPOKED

MP401

Our best selling metal wheel. The 4-foot circumference wheel levels out uneven ground by spanning divets that smaller wheels would dip in to. The wheel's size enables it to roll and register feet clicks at the best pace in the industry.

MP301

Not far behind the MP401 in popularity, this slightly more compact wheel is a little lower in price without compromising any durability.

MP301M

Our 1 meter circumference wheel registers a single meter click per revolution. It's about the same size as the MP301.

MP301DM

This is an industry first — we have 10 evenly spaced pins around the 1 meter circumference of this wheel. The result is a metal wheel that registers in decimeters.

MP401P

We mold 4-foot wheels for our RR series and for a less expensive alternative to the spoked wheels, we offer this model.

Limited lifetime warranty.

MODEL	UPC 052837	UNITS	DIA.	CIRC.	SPECIAL FEATURE
MP301	026128	ft.	11-1/2 in.	3 ft.	Best seller!
MP301M	025763	m	.318 m	1 m	Steel metric wheel
MP301DM	026265	m, dm	.318 m	1 m	Most accurate decimeter wheel
MP401	025756	ft.	15-1/2 in.	4 ft.	Best seller!
MP401P	026111	ft.	15-1/2 in.	4 ft.	Plastic wheel, metal frame
MPLGCASE	026876				Carrying case for wheel



3/4-inch steel frame for superior durability

Heavy-duty barrel clamp, unit folds to 1/2 size

Metal spoked wheel



MP401



MPLGCASE

Measuring Wheels

Levels

Long Tapes

Short Tapes

Specialty Measures

Chalk Line Reels

Chalk

Twine/Paint

Flagging Tape Etc. Specialty Marking

MP SERIES

METAL PROFESSIONAL SOLID WHEELS

There are advantages to solid wheels. A sliding tool box or a shovel in the back of a truck has destroyed the precision of many a spoked wheel. Solid plastic wheels are not nearly as susceptible to these impacts. Also, solid Keson wheels do not go “out of round.” You cannot bend them or flatten a portion of them. Lastly, twigs, sticks, tall grasses, and other brush do not get caught up in the spokes or lock these wheels up. If your job takes you through fields or trails, consider a solid wheel option.



Our geared Mechanical Clicker Counter features easy-to-read numbers.

FEATURES < MP SERIES SOLID

- 1. No Spokes** to catch grass or sticks and won't bend or snap.
- 2. Solid Molded Wheels** do not bend or go “out of round.”

MP415

The counter measures feet and there are two scales molded into the hub of the wheel itself: inches on one side and 10ths on the other.

MP315M

On our metric version, decimeter graduations are molded into the hub of the wheel.

MP201

Strong, rigid, 1-piece steel handle — strongest in the industry. Without a collapsing point in the handle, there is no weak point on this frame. This solid wheel is two inches wide, giving it better traction on sand, loose gravel and wet ground; a favorite among landscapers.

Limited lifetime warranty.

MODEL	UPC 052837	UNITS	DIA.	CIRC.	SPECIAL FEATURE
MP201	008315	ft.	7-1/2 in.	2 ft.	Solid molded wheel
MP315M	027040	m, dm	.318 m	1 m	Solid, metric
MP415	026449	ft., in & ft., 10ths	15-1/2 in.	4 ft.	Solid, two scales wheel
MPLGCASE	026876				Carrying case for wheel
MPSMCASE	026883				Carrying case for wheel

MP-SOLID 3 SKUS, 3 SIZES



3/4-inch steel frame for superior durability



Heavy-duty barrel clamp, unit folds to 1/2 size



MPLGCASE

MPSMCASE



MP201



KESON
MEASURING WHEELS

RRT SERIES

RRT6 / RRT12

The RRT Series focuses on control and comfort. Resetting has never been easier with two options, a reset on the handle AND on the unit housing. The center-line handle design makes this unit well balanced. Our compact fold-down uses a collapsing hinge and handle lock to reduce the unit to half its original size.

5-Digit, Easy read counte measures 9,999 feet, 11 inches (9,999.9 ft. on the engineers' models and 9,999.9 meters on metric).



FEATURES < RRT SERIES

- Enhanced Grip Pistol-type Handle** increases control and comfort.
- Brake on Pistol Grip** stops counting instantly. Stop adding lengths accidentally by putting the brake on exactly when you need it.
- Gear and Shaft Transmission** for highest measurement accuracy and strength. No belts to stretch or fail.
- Reset on the Handle and Unit Housing** no more bending over, lifting the wheel or stepping on it to reset to zero. Additionally, the reset on the housing is reinforced to protect it when resetting the counter with your foot.

2-year limited warranty.

MODEL	UPC 052837	UNITS	DIA.	CIRC.	SPECIAL FEATURE
RRT6	027422	ft. & in.	6 in.	18 in.	Handle trigger reset and brake
RRT610	027576	ft. & 10ths	6 in.	18 in.	
RRT6M	027569	m, dm	15.2 cm	45.7 cm	
RRT12	027415	ft. & in.	12 in.	3 ft.	Handle trigger reset and brake
RRT1210	027460	ft. & 10ths	12 in.	3 ft.	
RRT12M	027477	m, dm	.318 m	1 m	
RRT6BAG	028214				Carrying case for wheel
RRT12BAG	028207				Carrying case for wheel

RRT-BASIC 6 SKUS, 4 SIZES



Measuring Wheels

Levels

Long Tapes

Short Tapes

Specialty Measures

Chalk Line Reels

Chalk

Twine/Paint

Flagging Tape Etc. Specialty Marking

PLASTIC MEASURING WHEELS

KESONITE™ WHEEL SERIES

RRT-KESONITE
4 SKUS, 3 SIZES



There are inherent vulnerabilities of die cast and metal spoked wheels. Everyday use requires that a wheel handle some rough treatment without dents and without bending.

Not all wheels are up to this. Our solution? Invent a new material. Kesonite is a strong, dense metal/resin composite. It holds its shape better than metal and it's stronger than a spoked or die cast wheel. The weight of the wheel makes it easier to use and more accurate on rough terrain.

Based on the design of the RR Series Large, a model with over 20 years of continuous improvement, including wheel design, material, and safety reflector!

Easy-to-read, Magnified Counter 5-digit, easy-read, magnified counter measures 9,999 feet, 11 inches (9,999.9 ft on engineers' model and 9,999.9 meters on metric)



FEATURES < KESONITE™ SERIES

- 1. Pistol Grip Handle** increases control and comfort.
- 2. Quick Snap Cam Locks** to store and transport the wheel with minimal effort.
- 3. Telescopes down to 23 inches** cam locks make the unit simple to operate when preparing for storage or transportation.
- 4. Flip-Down Kickstand** keeps the wheel upright when you need your hands free to perform other tasks and stays out of the way as you measure.
- 5. Safety Reflector**



RR30



RRLGCASE

Limited lifetime warranty.

MODEL	UPC 052837	UNITS	DIA.	CIRC.	SPECIAL FEATURE
RR30	026425	ft., in.	11-1/2 in.	3 ft.	Increased strength & weight
RR3010	026524	ft., 10ths	11-1/2 in.	3 ft.	
RR30M	026500	m, dm	.318 m	1 m	
RR40	026463	ft., in.	15-1/2 in.	4 ft.	
RRLGCASE	026890				Carrying case for wheel

ROADRUNNER SERIES

CONTRACTOR GRADE

Over 20 years of continuous improvement — such as the new wheel design, kickstand and safety reflector! Extremely popular — tens of thousands sold every year.

The reset on the unit housing is reinforced to protect the unit when using feet. Heavy-duty polycast wheel has clean three-spoke design.

Easy-to-read, Magnified Counter 5-digit, easy-read, magnified counter measures 9,999 feet, 11 inches (9,999.9 ft on engineers' model and 9,999.9 meters on metric)



FEATURES < ROADRUNNER SERIES

- 1. Pistol Grip Handle** increases control and comfort.
- 2. Quick Snap Cam Locks** to store and transport the wheel with minimal effort.
- 3. Telescopes down to 23 inches** cam locks make the unit simple to operate when preparing for storage or transportation.
- 4. Flip-Down Kickstand** keeps the wheel upright when you need your hands free to perform other tasks and stays out of the way as you measure.
- 5. Safety Reflector**

RRT-CONTRACTOR 6 SKUS, 3 SIZES

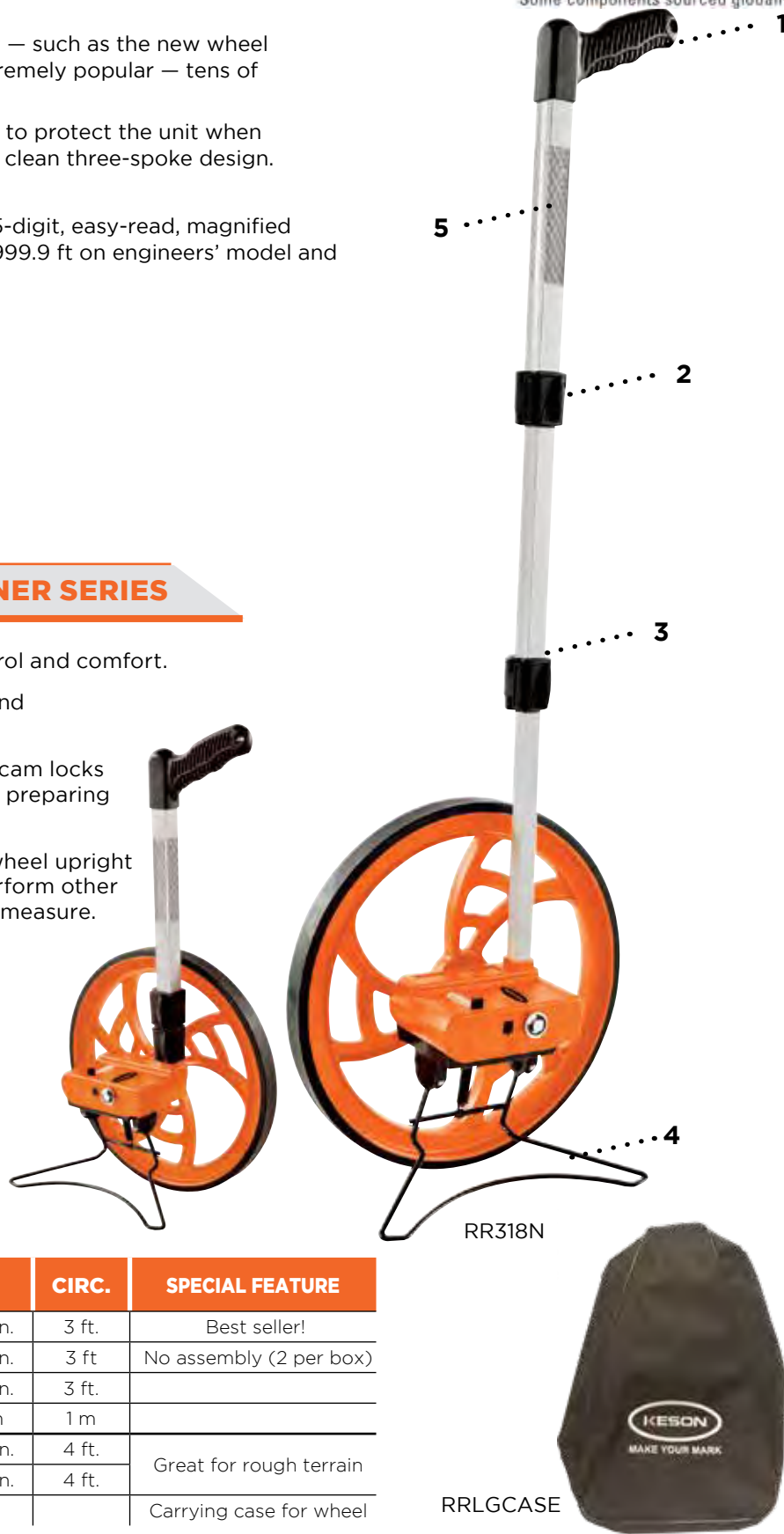

Limited lifetime warranty.

MODEL	UPC 052837	UNITS	DIA.	CIRC.	SPECIAL FEATURE
* RR318N	008506	ft., in.	12-1/2 in.	3 ft.	Best seller!
RR318N-2	008506	ft., in.	12-1/2 in.	3 ft.	No assembly (2 per box)
RR310	010172	ft., 10ths	12-1/2 in.	3 ft.	
RR3M	010189	m, dm	.318 m	1 m	
RR418	010196	ft., in.	15-1/2 in.	4 ft.	Great for rough terrain
RR410	010202	ft., 10ths	15-1/2 in.	4 ft.	
RRLGCASE	026890				Carrying case for wheel

* Some assembly required.

Measuring Wheels

Levels

Long Tapes

Short Tapes

Specialty Measures

Chalk Line Reels

Chalk

Twine/Paint

Flagging Tape Etc. Specialty Marking

ROADRUNNER SERIES

**RR-INDOOR
5 SKUS, 2 SIZES**



INDOOR/SHORT RUN WHEELS

Smaller 1-foot wheels combine Keson quality and reliability with convenient size and lightweight. Typically used in short run and indoor applications these products are compact and very reliable. It's easy to measure curved, horizontal, and asymmetrical surfaces.

These products are popular with realtors, appraisers, police officers and homeowners. You can measure alone, and you can measure faster than two people with a tape measure. Many of our customers keep one of these wheels as an emergency backup to their regular wheels.

Easy-to-read, Magnified Counter 5-digit, easy-read, magnified counter measures 9,999 feet, 11 inches (9,999.9 ft on engineers' model and 9,999.9 meters on metric)



SINGLE WHEEL
RR112



DUAL WHEEL
RR182

RRSMCASE

FEATURES < RR INDOOR SINGLE WHEEL

- 1. Weighs Less than 2 Pounds**
- 2. Telescopes Down to 17 Inches** fits into a toolbox or briefcase.
- 3. 38 Inches Tall when Fully Extended**

FEATURES < RR INDOOR DOUBLE WHEEL

- 1. Reset with Foot** a raised reset button that enables you to reset the counter with your foot. We have improved the supporting structure around the reset so that it can handle foot taps to zero the counter.
- 2. Greater Stability** when measuring, making it easier to maintain a straight line as you walk.
- 3. Telescopes Down to 20 Inches** fits into a toolbox or briefcase.
- 4. 42 Inches Tall when Fully Extended**

Limited lifetime warranty.

MODEL	UPC 052837	UNITS	DIAMETER	CIRC.	SPECIAL FEATURE
RR112	020058	ft., in.	4 in.	1 ft.	Best seller! One Wheel
RR110	020065	ft., 10ths	4 in.	1 ft.	
RR10M	020072	m, dm	.097 m	.305 m	
RR182	010592	ft., in.	4 in.	1 ft.	Dual-wheel stability
RR102	010608	ft., 10ths	4 in.	1 ft.	
RRSMCASE	026906				Carrying Case for Wheel

PAINT APPLICATORS

MEASURE AND MARK

Measure and mark simultaneously with **RRPA18** and **RRPA182**. These lightweight tools feature a trigger just under the pistol grip. Engaging the trigger fires off a burst of upside-down spray paint precisely where it's needed.

Easy-to-read, Magnified Counter The single wheel and dual wheel both have a 5-digit, easy-read, magnified counter that measures 9,999 feet, 11 inches without resetting. That's almost two miles.



FEATURES < PAINT APPLICATOR SERIES

- 1. Pistol Grip and Trigger** to spray paint exactly where you want it.
- 2. Paint Can Sleeve** fits all standard US-style inverted aerosol paint cans.
- 3. Reset with Foot** when using the RRPA18 or RRPA182.
- 4. Handheld Applicator**
- 5. Optional Wheel** PA35 comes with an attachable wheel.



Limited lifetime warranty.

MODEL	UPC 052837	UNITS	CIRC.	SPECIAL FEATURE
RRPA18	022298	ft. & in.	12 in.	Single wheel with applicator
RRPA182	020768	ft. & in.	12 in.	Dual wheel with applicator
PA14	010066			Handheld applicator
PA35	010059			Spray as you walk applicator

A LITTLE ABOUT LEVELS

Keson levels are among the best performing levels on the planet. We are very excited to utilize SOLA's long history of manufacturing excellence and cutting-edge innovation to provide an affordable version of high quality levels under the Keson brand. All Keson levels are made in either Austria or Hungary.

Keson Box Beam, Screed, and Torpedo Levels all contain the SOLA FOCUS vial.

WWW.SOLA.US



VIALS

Simply put, the vial is the heart of the level. Keson's box beam levels all come with FOCUS vials. These vials incorporate the superior contrast of all SOLA FOCUS vials, and have 20% greater magnification than a typical ring vial.

Vial Features

- Greater Contrast & 20% magnification
- Superior fluid
 - Anti-static
 - Extreme temperature ranges
 - Anti-shock action
- Luminous Strip

Benefits

- Easier to see the bubble and determine its position, for faster measurement
- Ensures you can work in any environment without interruption
- Bubble is unaffected by electricity
- Bubble is unaffected by too cold or too hot temperatures
- Bubble retains its integrity or returns to its shape more readily
- Allows visibility in low light conditions



SOLA vials in full light

SOLA vials in low light

PROFILES

A level's profile impacts the overall quality of the level. Better levels have more robust profiles—that is, they are heavier. How the vials are held in place is also critically important. In general, there are two types of profiles for general construction levels: Box Beam and I-Beam.

Box Beam Levels

Strongest profiles, best vials. Box Beam levels are the best levels for general construction. They combine the highest available accuracy, acrylic vials, durability, and ease of use. Box Beam levels are higher quality, and significantly more durable than I-Beam levels.

I-Beam Levels

Good general purpose, light use levels that need to be checked more regularly for accuracy. I-Beam levels are less durable by design. If treated carefully these levels can provide a long life; however, they do not have the robustness of Box Beam levels.



Screeding Levels

A specialty level that is designed for landscaping and concrete work. Our special H-beam design provides superior strength. They can also be used as a check rod. Built with the vial included in the tool, our screed level provides an extremely high degree of accuracy and consistency.



Box Beam Profile



I-Beam Profile



Screed Profile

PROFESSIONAL LEVELS FEATURING SOLA FOCUS VIALS

The most accurate vial available

KESON is thrilled to be partnered with SOLA Measuring Tools. Our new line of levels all feature Austrian-made SOLA vials, named the most accurate in the world. The majority of our levels feature the FOCUS-20 Vial, and include a 20% magnification to ensure an accurate reading.

Multiple styles and lengths are available, with options sure to perform well in every situation.



LKB
Box Beam



LKBM
Magnetic
Box Beam



LKBD
Digital Box Beam
(Also Available in
Magnetic)



LKI *
I-Beam



LKS
Screed Level

NOTE: All levels are made in Austria except * are made in Hungary.



LKTFM *
Magnetic
Torpedo Level



LKTSF
Plastic
Squared
Level



LKTRF
Plastic
Rounded
Level



LKTprm
Small Plastic
Magnetic Level



Actual Size

LKGOM
GO!
Magnetic



Actual Size

LKL3
Small Line
Level

Measuring Wheels

Levels

Long Tapes

Short Tapes

Specialty Measures

Chalk Line Reels

Chalk

Twine/Paint

Flagging Tape Etc. Specialty Marking

KESON BOX BEAM SERIES

Strong Profiles, Best Vials

For the price, Keson Box Beam levels are the best levels for construction available in North America. The new Keson Box Beam series provides professional grade levels for construction, and contain the SOLA FOCUS vial.

LKB SERIES 7 SKUS, 6 LENGTHS



FOCUS VIAL
by SOLA
⊕+20%

LKB SERIES

BOX BEAM LEVEL

SOLA FOCUS 20% Magnification Vial

Keson Box Beam Features

Heavy profile weight

Two material end caps

Single Measuring Surface

Tension Wedge vial mount in method

Vial Features

Greater Contrast and 20% magnification

Superior fluid

Anti-static

Extreme temperature ranges

Anti-shock action

Luminous Strip

Benefits

Ensures heavy usage

(and accidental abuse) does not compromise the performance of the level

Protect the level from damage due to drops

Highest accuracy and best user experience.

Users are cued to which surface to use with a single milled surface

Self-compensates for temperature changes

Among the two best methods for mounting vials within a level profile

Benefits

Easier to see the bubble and determine its position, for faster measurement

Ensures you can work in any environment without interruption

Bubble is unaffected by electricity

Bubble is unaffected by too cold or too hot temps

Bubble retains its integrity or returns to its shape more readily

Allows visibility in low light conditions

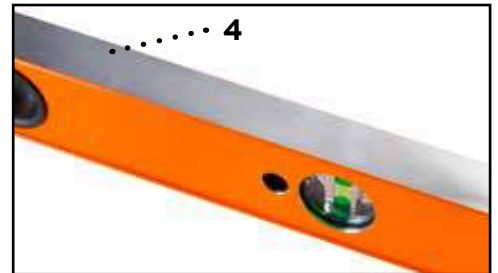

MODEL	UPC 052837	LENGTH	# VIALS	SPECIAL FEATURE
LKB24	028818	24 in.	3	no hand holds
LKB32	028825	32 in.	3	2 hand holds
LKB48	028832	48 in.	3	
LKB72	028849	72 in.	3	
LKB78	028856	78 in.	3	
LKB96	028863	96 in.	3	Jamb set
LKB7832	028870	32 in. & 78 in.	3 each	



≤0.0005 in./in. /
≤0.5 mm/m / ≤0.029°



≤0.00075 in./in. /
≤0.75 mm/m / ≤0.043°



860 G/M STRENGTH

BOX BEAM MAGNETIC SERIES

LKBM SERIES
6 SKUS, 5 LENGTHS



LKBM SERIES

MAGNETIC BOX BEAM LEVEL

SOLA FOCUS 20% Magnification Vial

All of the same features and benefits of the Keson Box Beam, with the addition of an extra strong magnetic hold.



FOCUS VIAL
by SOLA
Ø +20%

FEATURES < LKB/M SERIES

1. SOLA FOCUS Vial
2. Molded Hand Holds - levels 48" and longer
3. Rubber End Caps
4. Measuring Surface
5. Strong Magnetic Hold



MODEL	UPC 052837	LENGTH	# VIALS	SPECIAL FEATURE
LKB24M	028962	24 in.	3	Strong Hold Magnet
LKB32M	028979	32 in.	3	
LKB48M	028986	48 in.	3	Strong Hold Magnet 2 hand holds
LKB72M	028993	72 in.	3	
LKB78M	029006	78 in.	3	
LKB7832M	029013	32 in. & 78 in.	3 each	Jamb set



≤0.0005 in./in. /
≤0.5 mm/m / ≤0.029°



≤0.00075 in./in. /
≤0.75 mm/m / ≤0.043°



860 G/M STRENGTH



MAGNETIC

DIGITAL LEVEL SERIES

All the features and benefits of the standard box beam levels with digital read-out. Our Digital version is great for confirming ADA compliance, and comes with:

- Measuring tolerance module:
 - 0.05° at 0° and 90°
 - 0.1° between 1° and 89°
- Adjustable inclination display in °, %, mm/m and in/ft.
 - “Hold” function for storing measured values and for transferring angles.
 - Audible signal guidance available in difficult visible conditions.
 - Easy to see with reversible display for inverted measurements.
 - Protection class IP65 keeps the electronics safe from the environment.

LKBD SERIES 3 SKUS, 2 LENGTHS



FOCUS VIAL
by SOLA
⊕+20%

LKBD SERIES

DIGITAL

Digital readout on general construction levels

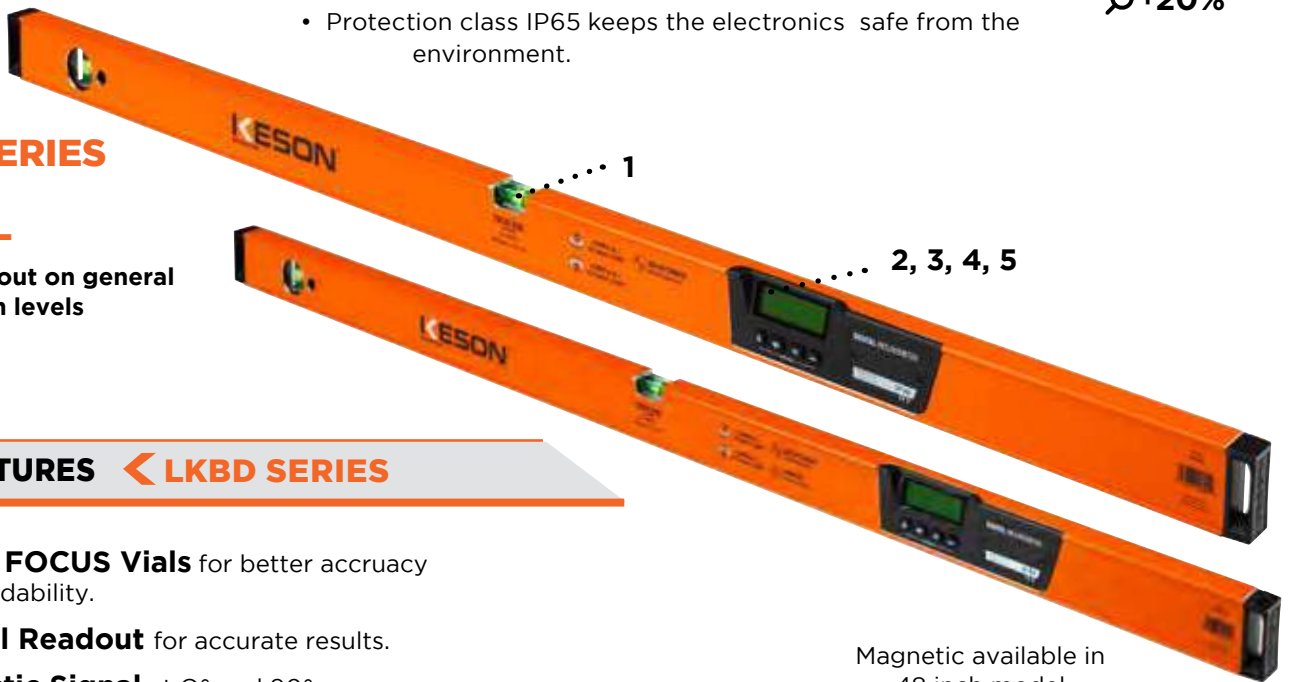

FEATURES < LKBD SERIES

1. **SOLA FOCUS Vials** for better accuracy and readability.
2. **Digital Readout** for accurate results.
3. **Acoustic Signal** at 0° and 90°.
4. **Mode Options** °, mm/m, %, in/ft.
5. **Display Options: ABS** (absolute) and **INC** (incremental).

Magnetic available in 48 inch model



MODEL	UPC 052837	LENGTH	# VIALS	SPECIAL FEATURE
LKB24D	028917	24 in.	2	Digital Readout
LKB48D	028924	48 in.	2	
LKB48DM	029020	48 in.	3	Magnetic



≤0.0005 in./in. /
≤0.5 mm/m / ≤0.029°



≤0.00075 in./in. /
≤0.75 mm/m / ≤0.043°



860 G/M STRENGTH

I-BEAM SERIES

General purpose levels for construction. The I-Beam level is a less expensive option for levels. By design, they are lighter and less durable than our Box Beam levels. If treated carefully these levels can provide a long life; however, they do not have the robustness of the Box Beam level. These lighter use levels need to be checked more regularly for accuracy.

Tube vials used in I-Beams are more susceptible to damage than an acrylic vial. One-material end caps provide some protection from accidental drops and misuse.

LKI SERIES 3 SKUS, 3 LENGTHS

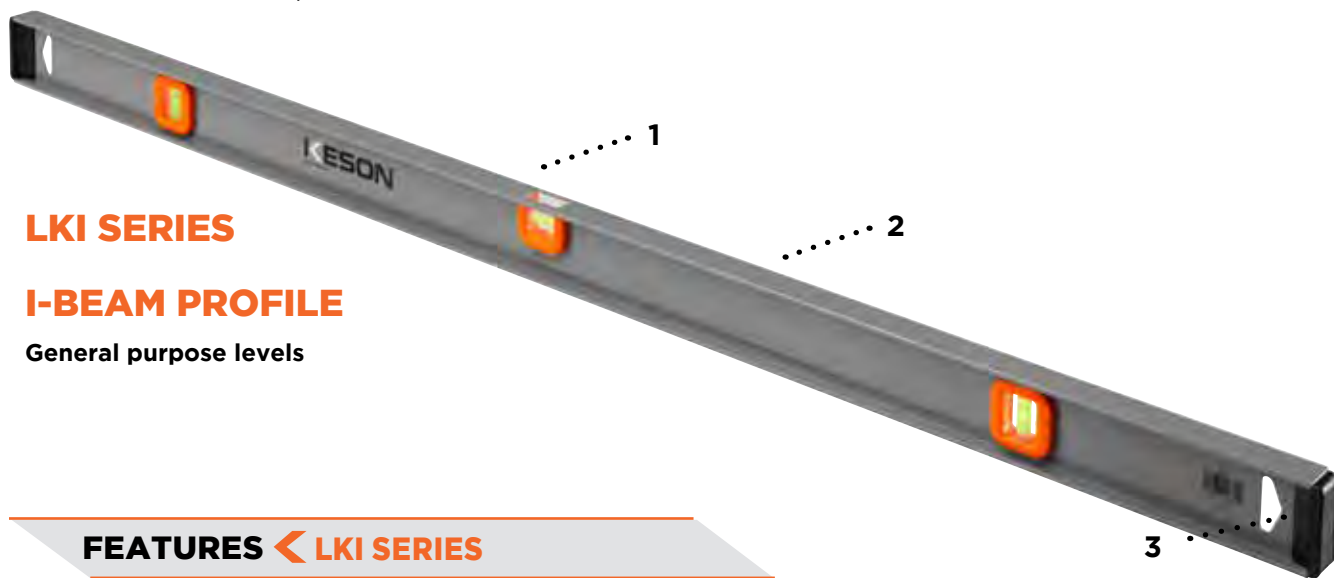
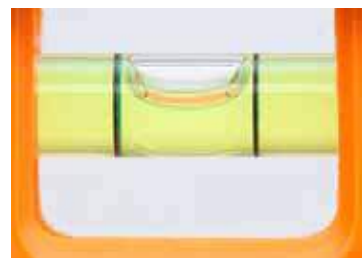

LKI SERIES

I-BEAM PROFILE

General purpose levels

FEATURES < LKI SERIES

1. **Ring Vials** made by SOLA.
2. **Profile weighs less than Box Beam.**
3. **End Caps** for protection.



I-Beam Profile without end cap

MODEL	UPC 052837	LENGTH	# VIALS	SPECIAL FEATURE
LKI24	028887	24 in.	3	Light weight
LKI48	028894	48 in.	3	
LKI72	028900	72 in.	3	

Measuring Wheels

Levels

Long Tapes

Short Tapes

Specialty Measures

Chalk Line Reels

Chalk

Twine/Paint

Flagging Tape Etc. Specialty Marking

SCREEDING SERIES

A specialty level that is the best level for landscaping and concrete work. Our special H-beam design provides superior strength. They can also be used as a check rod to ensure the flatness of whatever surface you're working on. The vial is built directly into the tool, providing a degree of accuracy and consistency not achievable with levels clipped onto screeds. No adjustments needed for clipped or screwed on vials.

LKS SERIES 6 SKUS, 5 LENGTHS



FOCUS VIAL
by SOLA

Keson Aluminum Screeding levels are designed for use in leveling cement, sand or paving stones in driveways, sidewalks and patios. This level has a high wall construction. Keson Screed levels are made to the most exacting European specifications. Will withstand rugged daily use and temperature changes. Easy to read Focus vial is made of shockproof acrylic for durability. Made in Austria.

LKS SERIES

Robust Outdoor Use Construction

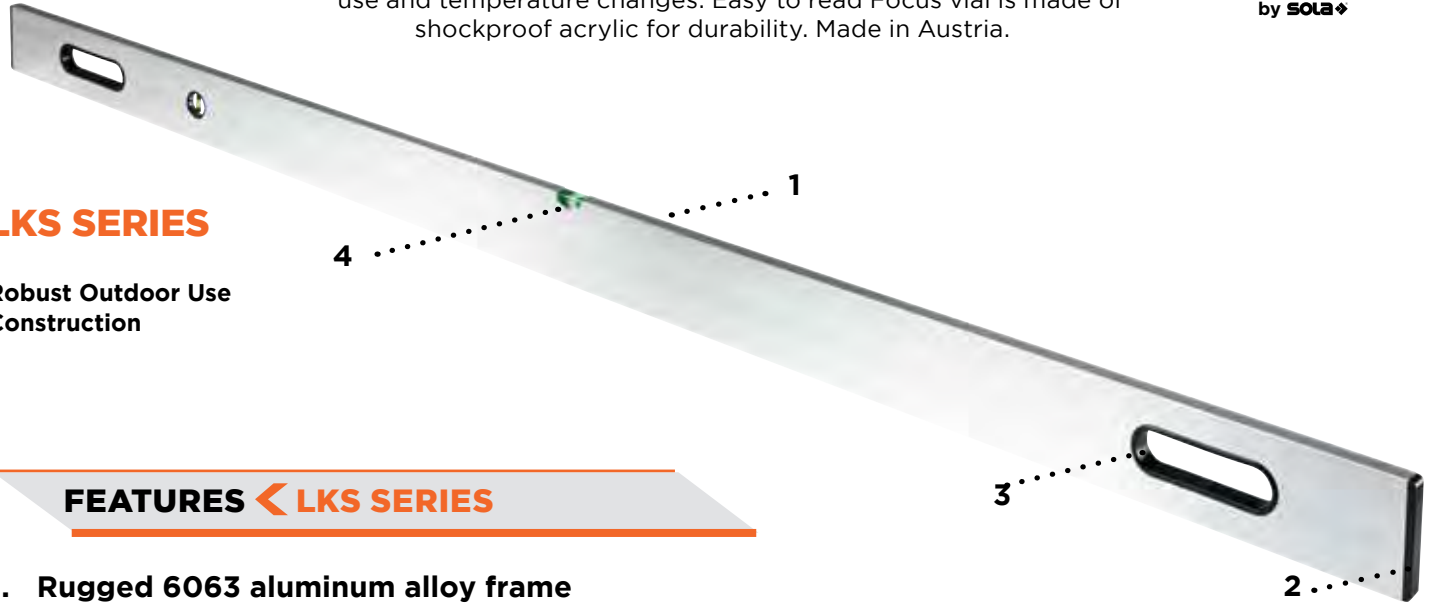

FEATURES < LKS SERIES

- 1. Rugged 6063 aluminum alloy frame** provides the highest accuracy for perfect measuring result.
- 2. End Caps** are shock absorbing, allowing the level to withstand use and abuse.
- 3. Wide handles** for use outside of the screeding area.
- 4. SOLA FOCUS Vials** for better accuracy and readability.

MODEL	UPC 052837	LENGTH	# VIALS	SPECIAL FEATURE
LKS39	029075	39 inches	2	No hand holds
LKS59	029082	59 inches	2	
LKS78	029099	78 inches	2	2 hand holes
LKS98	029105	98 inches	2	
LKS118	029112	118 inches	2	
LKS7839	029129	39 in. & 78 in.	2 each	

SHORT LEVELS/TORPEDOES

**SHORT LEVELS
6 SKUS**

Among the most popular levels we sell, short torpedo-style levels are great for quick checks and essential for some trades.



MODEL	UPC 052837	SPECIAL	VIAL	SPECIAL FEATURES
* LKTFM	029037	Die Cast	FOCUS-60	Extremely sturdy aluminum die-cast spirit level with a milled measuring surface and V-groove for scaffolding and steel pipes. FOCUS-60 vial for better, faster, and more accurate reading. .
* LKTSF	028948	Straight Edge	FOCUS-20	The classic torpedo with a FOCUS-20 vial.
* LKTRF	028931	Round Edge	FOCUS-20	A rounded edge on one side of this torpedo enables a builder to get flush against walls that have a bevel in the corner. We have yet to find it's equal.
* LKTPRM	029051	Straight Edge	Standard Ring	This is a no frills, magnetic torpedo.
LKGOM	029044	GO!	FOCUS-20	A magnetic, portable level with belt clip. Perfect for quick checks and spot-on accuracy.
LKL3	028955	Line Level	Standard Ring	Our 3-inch line level is perfect for keeping your wall, fence or grading level when attached to a taut string line.

* Display package available

Measuring Wheels

Levels

Long Tapes

Short Tapes

Specialty Measures

Chalk Line Reels

Chalk

Twine/Paint

Flagging Tape Etc. Specialty Marking

OPEN CASE STEEL BLADE TAPES



DOUBLE NYLON-COATED STEEL LONG TAPES

SILVER CRANK HANDLES = STEEL BLADES
BLACK CRANK HANDLES = FIBERGLASS BLADES

Since 1968, Keson steel tapes have met the **highest standards of accuracy** for surveyor quality measurements. They resist breakage and damage under the toughest field conditions. We understand that these tapes are critical to your profession. That's something we take very seriously, which is why we supply the best possible tapes we can.

Keson nylon-coated steel tapes are constructed with a double layered .2mm nylon, permanently bonded over a center core of 13mm steel. Our multi-layer construction assures corrosion resistance (even to salt water) and provides at least three times the usual tape life.

We have designed a variety of housing types for our customers: Stainless Steel (SNR), 3X High-Speed Rewind (NRS) and standard 1X rewind (NR). Double riveted or screwed cases, metal reinforced handles and shovel-style, rubber grips are standard on all of our offerings.

3/8-inch wide blades are about 10-20% lighter than 1/2-inch wide blades, without sacrificing durability. The thinner blades are also less likely to drift if the wind kicks up.

Keson offers the widest product selection of double nylon-coated blades. Units, attachments and zero points vary because of the precise needs of our many customers.

ZERO POINTS Where do the numbers start?

▼ Hook End, most common

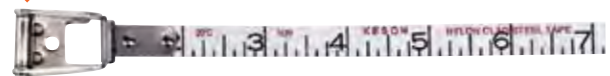

▼ Tape End, typical with ring attachment

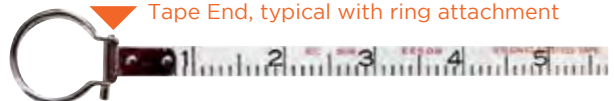

Ring Dead Foot — on the tape about 1-ft. from ring end ▼

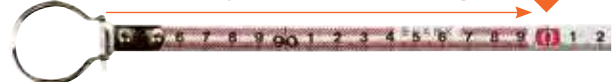

SNR SERIES

SNR SERIES
13 SKUS, 4 LENGTHS

STAINLESS STEEL HOUSING, NYLON-REINFORCED STEEL BLADE

The world's best steel long tape in a housing that's built to last!

The strongest housing (stainless steel!) on the market. There is no better housing available for our double nylon-coated steel blade. Both case and blades are built to ensure a long life under field abuse. Our rubber-grip shovel handle offers a comfortable, secure grip. The crank arm is metal as well.

FEATURES < SNR SERIES

1. **Rubber-Grip Shovel Handle** for comfortable, rapid reeling.
2. **Metal Crank Handle** for durability.
3. **Tough, Double Nylon-Coated Steel Blade** assures long life under field abuse.
4. **Housing Reinforced with Rivets** for superior strength.
5. **Strongest Housing on the Market!**



SNR10300

Limited lifetime warranty.

MODEL	UPC 052837	LENGTH	UNITS	ZERO POINT	ATTACHMENT	BLADE*
SNR18100	025985	100 ft.	ft, in, 1/8	Hook End	Hook	E1
SNR10100	026050	100 ft.	ft, 1/10, 1/100	Tape End + 1 ft	Ring	E19
SNR10100H	026197	100 ft.	ft, 1/10, 1/100	Hook End	Hook	E22
SNR18200	025992	200 ft.	ft, in, 1/8	Hook End	Hook	E1
SNR10200	026067	200 ft.	ft, 1/10, 1/100	Tape End + 1 ft	Ring	E19
SNR10200H	026258	200 ft.	ft, 1/10, 1/100	Hook End	Hook	E22
SNR18300	003501	300 ft.	ft, in, 1/8	Hook End	Hook	E1
SNR10300	003600	300 ft.	ft, 1/10, 1/100	Tape End + 1 ft	Ring	E19
SNR10300E	022854	300 ft.	ft, 1/10, 1/100	Tape End	Ring	E2
SNR10300H	003624	300 ft.	ft, 1/10, 1/100	Hook End	Hook	E22
SNR100M	003808	100m	m, cm, mm	Tape End + .3m	Ring	E17
SNR100ME	003907	100m	m, cm, mm	Tape End	Ring	E23
SNR100MH	022779	100m	m, cm, mm	Hook End	Hook	E3

*See Page 68

NRS SERIES

NYLON-REINFORCED STEEL BLADE, 3X HIGH-SPEED REWIND

3X rewind, high-visibility housing!

This 3X rewind series has the strongest gearing available. With metal, planetary gears, you can bring your steel tape back swiftly. Even with the weight of 300 feet or 100 meters of steel laying on a rough surface, our gears and metal-reinforced crank handle enables you to overcome the tape's inertia with ease.

**NRS SERIES
12 SKUS, 7 LENGTHS**

FEATURES < NRS SERIES

1. **Rubber-Grip Shovel Handle** for comfortable, rapid reeling.
2. **High-Visibility Orange Polycarbonate Case**
3. **Metal, Planetary Gearing** for super-fast rewind & no more stripped gears.
4. **Tough, Double Nylon-Coated Steel Blade** assures long life under field abuse.
5. **Metal Reinforced Handle** for superior strength.
6. **3X Rewind**



Limited lifetime warranty.

MODEL	UPC 052837	LENGTH	UNITS	ZERO POINT	ATTACHMENT	BLADE*
NRS18100	020980	100 ft.	ft, in, 1/8	Hook End	Hook	E1
NRS10100H	022687	100 ft.	ft, 1/10, 1/100	Hook End	Hook	E22
NRS18M100	028061	100 ft./30m	ft, in, 1/8 & m, cm, mm	Hook End	Double Hook	E1 & E15
NRS18200	021000	200 ft.	ft, in, 1/8	Hook End	Hook	E1
NRS10200H	022694	200 ft.	ft, 1/10, 1/100	Hook End	Hook	E22
NRS18M200	028078	200 ft./60m	ft, in, 1/8 & m, cm, mm	Hook End	Double Hook	E1 & E15
NRS18300	021017	300 ft.	ft, in, 1/8	Hook End	Hook	E1
NRS10300H	022700	300 ft.	ft, 1/10, 1/100	Hook End	Hook	E22
NRS18M330	028368	330 ft./100m	ft, in, 1/8 & m, cm, mm	Hook End	Double Hook	E1 & E15
NRS30M	027484	30m	m, cm, mm	Tape End + .3m	Ring	E17
NRS50M	027491	50m	m, cm, mm	Tape End + .3m	Ring	E17
NRS100M	027507	100m	m, cm, mm	Tape End + .3m	Ring	E17

*See Page 68

NR SERIES

NYLON-REINFORCED STEEL BLADE, STANDARD REWIND

A Keson best seller! Since 1968 this style of Keson steel tape has been providing customers with accurate measurements. They are used in the harshest conditions in which people measure, and they stand up to the only test that matters: field performance.

FEATURES < NR SERIES

- 1. Double Screws** hold housing together in case of an accidental drop.
- 2. Improved Plastic and Molding Shape** for increased durability and long life.
- 3. Tough, Double Nylon-Coated, 3/8-Inch Steel Blade** assures long life under field abuse, with reduced weight and wind drift.
- 4. Metal Reinforced Handle** for superior strength.
- 5. Break-Resistant Polycarbonate Case**



Limited lifetime warranty.

MODEL	UPC 052837	LENGTH	UNITS	ZERO POINT	ATTACHMENT	BLADE*
NR18100	001903	100 ft.	ft, in, 1/8	Hook End	Hook	E1
NR10100	002207	100 ft.	ft, 1/10, 1/100	Tape End + 1 ft	Ring	E19
NR10100E	022823	100 ft.	ft, 1/10, 1/100	Tape End	Ring	E2
NR10100H	002504	100 ft.	ft, 1/10, 1/100	Hook End	Hook	E22
NR18165	009916	165 ft.	ft, in, 1/8	Hook End	Hook	E1
NR18200	001927	200 ft.	ft, in, 1/8	Hook End	Hook	E1
NR10200	002221	200 ft.	ft, 1/10, 1/100	Tape End + 1 ft	Ring	E19
NR10200E	022847	200 ft.	ft, 1/10, 1/100	Tape End	Ring	E2
NR10200H	002528	200 ft.	ft, 1/10, 1/100	Hook End	Hook	E22
NR30M	002801	30m	m, cm, mm	Tape End + 1 ft	Ring	E17
NR30ME	003105	30m	m, cm, mm	Tape End	Ring	E23
NR30MH	022740	30m	m, cm, mm	Hook End	Hook	E3
NR50M	002825	50m	m, cm, mm	Tape End + .3m	Ring	E17
NR50ME	003129	50m	m, cm, mm	Tape End	Ring	E23
NR50MH	002757	50m	m, cm, mm	Hook End	Hook	E3
NR60M	002818	60m	m, cm, mm	Tape End + .3m	Ring	E17
NR60ME	003112	60m	m, cm, mm	Tape End	Ring	E23
NR60MH	002764	60m	m, cm, mm	Hook End	Hook	E3

*See Page 68

Measuring Wheels

Levels

Long Tapes

Short Tapes

Specialty Measures

Chalk Line Reels

Chalk

Twine/Paint

Flagging Tape Etc. Specialty Marking

CLOSED CASE STEEL BLADE TAPES

ST SERIES
5 SKUS, 2 LENGTHS

ST SERIES

Our standard Steel Tape (ST) series tapes come in the industry's most durable metal housing. These long, steel tapes have a compact, closed, metal case that fits nicely in your hand. The flush-folding crank pops up for easy rewinding. The graduations are painted black on a durable, bright-yellow steel blade.

FEATURES < ST SERIES

1. **Closed, Metal Housing** protects the tape.
2. **Rewind Handle** Folds Flush
3. **Compact**, fits easily into briefcase or a pocket.

Limited lifetime warranty.

MODEL	UPC 052837	LENGTH	UNITS	ZERO POINT	ATTACHMENT	BLADE*
ST5018	010394	50 ft.	ft, in, 1/8	Hook End	Hook	G1
ST5010	010721	50 ft.	ft, 1/10, 1/100	Hook End	Hook	G2
ST10018	010387	100 ft.	ft, in, 1/8	Hook End	Hook	G1
ST10010	010738	100 ft.	ft, 1/10, 1/100	Hook End	Hook	G2
ST10018M	027651	100 ft./30m	ft, in, 1/8 & m, cm, 2mm	Hook End	Double Hook	G1 & G3



ST10018

*See Page 68

ST_3X & ST_Y SERIES

NYLON-REINFORCED STEEL BLADE, 3X HIGH-SPEED REWIND

3X rewind, high-visibility housing!

This Steel Tape (ST_3X and ST_Y) series is great for those who need a longer tape but like the blade protection that a closed house offers. The ST_Y versions come with a belt clip.

FEATURES < ST_3X & ST_Y SERIES

1. **High-Impact Resistant Case** with full-rubber non-slip grip.
2. **Lacquer-Coated, 3/8-Inch Steel Blade** for superior durability and rust resistance.
3. **3X Gearing (3X Series)** for super-fast rewind & no more stripped gears.

Limited lifetime warranty.

MODEL	UPC 052837	LENGTH	UNITS	ZERO POINT	ATTACHMENT	BLADE*
ST18503X	027248	50 ft.	ft, in, 1/8	Hook End	Hook	G1
ST10503X	027385	50 ft.	ft, 1/10, 1/100	Hook End	Hook	G2
ST181003X	026531	100 ft.	ft, in, 1/8	Hook End	Hook	G1
ST101003X	027118	100 ft.	ft, 1/10, 1/100	Hook End	Hook	G2
ST18M503X	027644	50 ft./15m	ft, in, 1/8 & m, cm, 2mm	Hook End	Double Hook	G1 & G3
ST18M1003X	027620	100 ft./30m	ft, in, 1/8 & m, cm, 2mm	Hook End	Double Hook	G1 & G3
ST1833Y						
ST1850Y	023509	50 ft.	ft, in, 1/8	Hook End	Hook	G1
ST18100Y	023516	100 ft.	ft, in, 1/8	Hook End	Hook	G1



ST18100Y

*See Page 68

OPEN CASE FIBERGLASS BLADE TAPES



SILVER CRANK HANDLES = STEEL BLADES
BLACK CRANK HANDLES = FIBERGLASS BLADES

HEAVY-DUTY

FIBERGLASS LONG TAPES

Since 1968, Keson fiberglass tapes have met the **highest standards of accuracy** for quality measurements. They resist breakage and damage under the toughest field conditions. We understand that these tapes are critical to your profession. That's something we take very seriously, and that is why we supply the best possible tapes we can. We cover each blade with two coats of PVC protected by double shield, one to bind the fiberglass strands and a second over the printed units, so the numbers don't wear away.

BLADES

Keson fiberglass reinforced tapes are designed to withstand more wear and tear than any other type of fiberglass measuring tape. They contain **40,000 fiberglass strands** for greater tensile strength and superior accuracy when tension is applied. Two coats of PVC protect the tapes from breaking, and a blade shield adds strength to the attachment (the point at which most fiberglass tapes break). These tapes have proven dielectric strength of 200,000 V/M to assure your safety from electrical hazards.

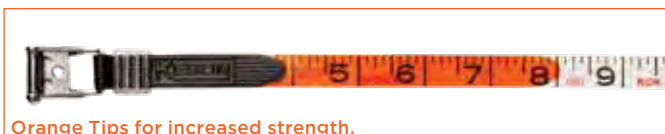

Orange Tips for increased strength.

FIBER COUNT & TAPE WEIGHT

The weight of a tape is a factor to consider if you do a great deal of measuring. With our heavy-duty fiberglass tapes, we pack the strongest possible fibers — and the greatest number — into the thinnest possible tapes to keep the weights down while keeping the blades strong.

ELONGATION

Tapes elongate (stretch) when excessive pulling force is applied. Keson heavy-duty fiberglass always returns to its proper length after the pulling stops. The reason is our high fiberglass strand count. To keep your fiberglass measurements as accurate as possible, don't pull too hard when making your measurements.

HOUSINGS

We have designed a variety of housing types for our customers: Freewheeling Long Tape (FLT), 3X High-Speed Rewind (OTRS) and Standard 1X Rewind (OTR). Double riveted or screwed cases, metal reinforced handles and shovel-style, rubber grips are standard on all of our offerings.

PRODUCT SELECTION

Keson offers the widest product selection of fiberglass blades. Units, attachments and zero points vary because of the precise needs of our many customers.

FLT SERIES

FREEWHEELING

3X rewind, high-visibility housing!

Our patented freewheeling release enables you to disengage the gearing, paying out the blade without a whirling handle.

Count on Keson Fiberglass Tapes for the strength and accuracy you expect on your job. Easy-to-read permanently bonded graduations. Folding end hook. The cross-arm open reel has a folding rewind handle and a “stake point.” Designed to withstand more wear and tear than any other kind of measuring tape! Given the roughest treatment possible... trampled underfoot, dragged through mud, dust, or rock abrasion, Keson fiberglass tapes go on taking abuse with little or no deterioration.

FLT SERIES 8 SKUS, 3 LENGTHS



FEATURES < FLT SERIES

1. Ergonomically Designed Housing

Handle with tactile rubber grip for balance and comfort.

2. Freewheeling Hub for fast pay out of blade without spinning crank. No more busted knuckles! Re-engage with the push of a button.

3. Locking Pawl enables proper blade tension during measurement.

4. Double PVC Coated Fiberglass Blade is nonconducting, top-quality, and won't shrink or deteriorate.

5. Massive Crank Arm with large, easy-grip knob for comfort and reliability.

6. Knob Folds Down for Storage



FLT18200

Limited lifetime warranty.

MODEL	UPC 052837	LENGTH	UNITS	ZERO POINT	ATTACHMENT	BLADE*
FLT18165	027170	165 ft.	ft, in, 1/8	Hook End	Hook	F1
FLT10165	027187	165 ft.	ft, 1/10, 1/100	Hook End	Hook	F2
FLT18M165	027163	165 ft./50m	ft, in, 1/8 & m, cm, 2mm	Hook End	Double Hook	F1 & F13
FLT18200	027156	200 ft.	ft, in, 1/8	Hook End	Hook	F1
FLT10200	027132	200 ft.	ft, 1/10, 1/100	Hook End	Hook	F2
FLT1810200	027316	200 ft.	ft, in, 1/8 & ft, 1/10, 1/100	Hook End	Double Hook	F1 & F14
FLT18M200	027149	200 ft./60m	ft, in, 1/8 & m, cm, 2mm	Hook End	Double Hook	F1 & F13
FLT50MM	027194	50m	m, cm, 5mm & m, cm, 2mm	Hook End	Hook	F12 & F13

*See Page 69

OTRS SERIES

3X HIGH-SPEED REWIND

3X rewind, high-visibility housing!

Our best offering in a fiberglass housing. The OTRS series pairs an incredibly durable housing with our excellent blades. End caps on the arms further protect the housing. We cover each blade with two coats of PVC protected by double shield, one to bind the fiberglass strands and a second over the printed units, so the numbers don't wear away.

The 3X high-speed rewind gearing is made up of metal, strip-proof gearing.

OTRS SERIES

14 SKUS, 4 LENGTHS

FEATURES < OTRS SERIES

1. **Rubber Shovel Handle** for a comfortable, "no-slip" grip.
2. **Metal, Strip-Proof Gearing**
3. **Double PVC Coated Fiberglass Blade** with additional tape end guard for ultimate tape protection.
4. **Metal Reinforced Crank Handle** lasts longer.
5. **End Caps** on the arms further protect the housing.



Metal reinforced handle

MODEL	UPC 052837	LENGTH	UNITS	ZERO POINT	ATTACHMENT	BLADE*
OTRS18100	027217	100 ft.	ft, in, 1/8	Hook End	Hook	F1
OTRS10100H	026746	100 ft.	ft, 1/10, 1/100	Hook End	Hook	F2
OTRS1810100	028085	100 ft.	ft, in, 1/8 & ft, 1/10, 1/100	Hook End	Double Hook	F1 & F14
OTRS1810100E	027675	100 ft.	ft, in, 1/8 & ft, 1/10, 1/100	Tape End	Ring	F20
OTRS18M100	028108	100 ft./30m	ft, in, 1/8 & m, cm, 2mm	Hook End	Double Hook	F1 & F13
OTRS18200	027224	200 ft.	ft, in, 1/8	Hook End	Hook	F1
OTRS10200H	026753	200 ft.	ft, 1/10, 1/100	Hook End	Hook	F2
OTRS1810200	028160	200 Ft.	ft, in, 1/8 & ft, 1/10, 1/100	Hook End	Double Hook	F1 & F14
OTRS1810200E	026005	200 ft.	ft, in, 1/8 & ft, 1/10, 1/100	Tape End	Ring	F20
OTRS18M200	028177	200 ft./60m	ft, in, 1/8 & m, cm, 2mm	Hook End	Double Hook	F1 & F13
OTRS18300	027231	300 ft.	ft, in, 1/8	Hook End	Hook	F1
OTRS10300H	026760	300 ft.	ft, 1/10, 1/100	Hook End	Hook	F2
OTRS1810300E	026012	300 ft.	ft, in, 1/8 & ft, 1/10, 1/100	Tape End	Ring	F20
OTRS1810330	028092	330 ft.	ft, in, 1/8 & ft, 1/10, 1/100	Hook End	Double Hook	F1 & F14

*See Page 69

OTR SERIES

OPEN-TYPE REEL, ULTRA-GLASS BLADE, STANDARD

A Keson best seller! Since 1968 this style of Keson fiberglass tape has been providing customers with accurate measurements. They are used in the harshest conditions in which people measure, and they stand to the only test that matters: field performance. We cover each blade with two coats of PVC protected by double shield, one to bind the fiberglass strands and a second over the printed units, so the numbers don't wear away.

OTR SERIES 32 SKUS, 9 LENGTHS

FEATURES < OTR SERIES

- 1. Tough, Molded Shovel Handle** is easy to grasp and is ideal for rapid reeling.
- 2. Double PVC Coated Fiberglass Blade** for ultimate tape protection.
- 3. Double Throat Rollers** guide the blade return and prevent the tape from twisting.
- 4. Crank Handle** is reinforced with metal to provide years of rugged use.
- 5. Better Blade Axle** to reduce breakage due to weight of the tape if dropped.



Metal reinforced handle



OTR18200

Limited lifetime warranty.

MODEL	UPC 052837	LENGTH	UNITS	ZERO POINT	ATTACHMENT	BLADE*
OTR1850	000203	50 ft.	ft, in, 1/8	Hook End	Hook	F1
OTR1050	001408	50 ft.	ft, 1/10, 1/100	Hook End	Hook	F2
OTR181050	000807	50 ft.	ft, in, 1/8 & ft, 1/10, 1/100	Hook End	Double Hook	F1 & F14
OTR18M50	000500	50 ft./15m	ft, in, 1/8 & m, cm, 2mm	Hook End	Double Hook	F1 & F13
OTR10M50	001101	50 ft./15m	ft, 1/10, 1/100 & m, cm, 2mm	Hook End	Double Hook	F2 & F13
OTR18100	000210	100 ft.	ft, in, 1/8	Hook End	Hook	F1
OTR10100	001415	100 ft.	ft, 1/10, 1/100	Hook End	Hook	F2
OTR1810100	000814	100 ft.	ft, in, 1/8 & ft, 1/10, 1/100	Hook End	Double Hook	F1 & F14
OTR18M100	000517	100 ft./30m	ft, in, 1/8 & m, cm, 2mm	Hook End	Double Hook	F1 & F13
OTR10M100	001118	100 ft./30m	ft, 1/10, 1/100 & m, cm, 2mm	Hook End	Double Hook	F2 & F13
OTR18165	000227	165 ft.	ft, in, 1/8	Hook End	Hook	F1
OTR10165	001422	165 ft.	ft, 1/10, 1/100	Hook End	Hook	F2
OTR18M165	000524	165 ft./50m	ft, in, 1/8 & m, cm, 2mm	Hook End	Double Hook	F1 & F13
OTR10M165	001125	165 ft./50m	ft, 1/10, 1/100 & m, cm, 2mm	Hook End	Double Hook	F2 & F13
OTR18200	000234	200 ft.	ft, in, 1/8	Hook End	Hook	F1
OTR10200	001439	200 ft.	ft, 1/10, 1/100	Hook End	Hook	F2
OTR1810200	000838	200 ft.	ft, in, 1/8 & ft, 1/10, 1/100	Hook End	Double Hook	F1 & F14
OTR18M200	000531	200 ft./60m	ft, in, 1/8 & m, cm, 2mm	Hook End	Double Hook	F1 & F13
OTR10M200	001132	200 ft./60m	ft, 1/10, 1/100 & m, cm, 2mm	Hook End	Double Hook	F2 & F13
OTR18300	000241	300 ft.	ft, in, 1/8	Hook End	Hook	F1
OTR10300	001446	300 ft.	ft, 1/10, 1/100	Hook End	Hook	F2
OTR1810300	000845	300 ft.	ft, in, 1/8 & ft, 1/10, 1/100	Hook End	Double Hook	F1 & F14
OTR18M300	000548	300 ft./100m	ft, in, 1/8 & m, cm, 2mm	Hook End	Double Hook	F1 & F13
OTR10M300	001149	300 ft./100m	ft, 1/10, 1/100 & m, cm, 2mm	Hook End	Double Hook	F2 & F13
OTR15M	001040	15m	m, cm, 2mm	Hook End	Hook	F3
OTR15MM	010448	15m	m, cm, 5mm & m, cm, 2mm	Hook End	Double Hook	F12 & F13
OTR30M	010417	30m	m, cm, 2mm	Hook End	Hook	F3
OTR30MM	010455	30m	m, cm, 5mm & m, cm, 2mm	Hook End	Double Hook	F12 & F13
OTR50M	010424	50m	m, cm, 2mm	Hook End	Hook	F3
OTR50MM	010462	50m	m, cm, 5mm & m, cm, 2mm	Hook End	Double Hook	F12 & F13
OTR100M	010431	100m	m, cm, 2mm	Hook End	Hook	F3
OTR100MM	020027	100m	m, cm, 5mm & m, cm, 2mm	Hook End	Double Hook	F12 & F13

*See Page 69

CLOSED CASE FIBERGLASS BLADE TAPES

"This is it! If you work with a tape measure every day, this is the tape. It's accurate and reliable. I have been working with one for the past 12 years."

Appraiser, Scott

MC SERIES

METAL CASE BLADE

We know that blade protection is key to a long tape life. Our metal case (MC) keeps the blades safe. These long, fiberglass tapes have a compact, closed metal case that fits nicely in your hand. The flush-folding crank pops up for easy rewinding. If you're measuring alone, the metal catch hook is set at zero, so there's no need for a correction. These are very popular with users that primarily do interior measurements.

MC SERIES 10 SKUS, 2 LENGTHS

FEATURES < MC SERIES

- 1. Metal Crank Handle** to provide years of rugged use.
- 2. Double-Throat Rollers** guide the blade return and prevent the tape from twisting.
- 3. Heavy-Duty 1/2-Inch Blades** with 40,000 strands of fiberglass ensures a long life under the most demanding field use.
- 4. Closed, Metal Housing** protects the tape.



MC18100

Limited lifetime warranty.

MODEL	UPC 052837	LENGTH	UNITS	ZERO POINT	ATTACHMENT	BLADE*
MC1850	000104	50 ft.	ft, in, 1/8	Hook End	Hook	F31
MC1050	001309	50 ft.	ft, 1/10, 1/100	Hook End	Hook	F32
MC181050	000708	50 ft.	ft, in, 1/8 & ft, 1/10, 1/100	Hook End	Double Hook	F31 & F44
MC18M50	000401	50 ft./15m	ft, in, 1/8 & m, cm, 2mm	Hook End	Double Hook	F31 & F43
MC10M50	001002	50 ft./15m	ft, 1/10, 1/100 & m, cm, 2mm	Hook End	Double Hook	F32 & F43
MC18100	000111	100 ft.	ft, in, 1/8	Hook End	Hook	F31
MC10100	001316	100 ft.	ft, 1/10, 1/100	Hook End	Hook	F32
MC1810100	000715	100 ft.	ft, in, 1/8 & ft, 1/10, 1/100	Hook End	Double Hook	F31 & F44
MC18M100	000418	100 ft./30m	ft, in, 1/8 & m, cm, 2mm	Hook End	Double Hook	F31 & F43
MC10M100	001019	100 ft./30m	ft, 1/10, 1/100 & m, cm, 2mm	Hook End	Double Hook	F32 & F43

*See Page 69

⚠ WARNING!

This product can expose you to chemicals including LEAD which is known to the State of California to cause cancer or birth defects or reproductive harm. For more information, visit www.p65Warnings.ca.gov.

SHORT TAPE MEASURES SUMMARY

CHROME SERIES

Our most popular model, this chrome coated, compact housing comes in more lengths and units than any of our other offerings.



TOGGLE SERIES

HV Toggle locking, brightly colored case in our second most numerous offering.

Fractional Decimal Tape: our specialty tapes that break inches into decimals on one edge and fractions along the other.



ULTRA BRIGHT BLADE

HV Ultra bright blade tapes are easy-to-read in low light environments and feature large-print and high-contrast numbers, and a vertical blade on the opposite side.



WIDE BLADE

HV Our redesigned wide blade tapes feature a 1-3/16 inch blade with bigger numbers and a standout up to 10 feet.

The new Wide Tape is highly visible.



AUTOMATIC LOCK

HV The blade lock automatically engages. Our second most popular tape retracts with the push of the button.



PROFESSIONAL

This stainless steel housing offers our highest impact resistance with an improved rubber grip.

HV A highly visible version of our Pro Tape.



NEW! MAGNETIC TIP

The magnetic hook end sticks to any metal surface, enabling up to 10 feet of tape extension.

HV A highly visible version of our Magnetic Tip Tape.



ECONOMY SERIES

HV Economically priced series.



CHROME SERIES

PG_ 18 SKUS, 10 LENGTHS

Our most popular model. Our chrome series features, chrome-coated, high-Impact ABS cases with a textured rubber grip. All blades are nylon coated for longer life and abrasion resistance. Along with our Toggle series, this style has been around for years and is among our most popular. That is why we offer all of our standard unit options in this family.

PLEASE NOTE: Our chrome tapes are going to be replaced with our PGPRO_V series. If the tape you are looking for is not available, consider the PGPRO_V or PGT_V series.

FEATURES < CHROME SERIES

- 1. Nylon-Coating** extends life of the blade.
- 2. High-Impact, Chrome-Coated, ABS Case** protects the blade and stands up to heavy use.
- 3. Textured Rubber Grip** is comfortable and helps prevent slipping.



A: 5/8-inch wide, nylon-coated, short tape

A1 = SAE: ft., in., 1/8, 1/16 (1/32 in. first ft.)

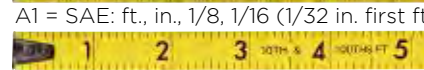

A2 = ENG: ft., 1/10, 1/100



A4 = ENG/SAE: ft., 1/10, 1/100 & ft., in., 1/8, 1/16



A5 = SAE/M: ft., in., 1/8, 1/16 & cm, mm



A20 = M: cm, mm

B: 1-inch wide, nylon-coated, short tape



B1 = SAE: ft., in., 1/8, 1/16 (1/32 in. first ft.)



B2 = ENG: ft., 1/10, 1/100



B3 = METRIC: cm, mm



B4 = ENG/SAE: ft., 1/10, 1/100 & ft., in., 1/8, 1/16



B5 = SAE/M: ft., in., 1/8, 1/16 & cm, mm



B6 = ENG/M: ft., 1/10, 1/100 & cm, mm

PRODUCT FEATURES & BENEFITS

Lock	Slide
Case	Chrome-coated ABS with Rubber Grip
Blade	Nylon-coated steel

MODEL	UPC 052837	LENGTH	UNITS	WIDTH (IN)	STAND OUT (FT)	BLADE*
PG1810	028191	10 ft.	ft, in, 1/8, 1/16 (1/32 first 12")	5/8"	N/A	A1
PG18M10	027842	10 ft./3m	ft, in, 1/8, 1/16 & cm, mm	5/8"	up to 8'	A5
PG1812	021987	12 ft.	ft, in, 1/8, 1/16 (1/32 first 12")	5/8"	up to 5'	A1
PG1012	027767	12 ft.	ft, 1/10, 1/100	5/8"	up to 5'	A2
PG181012	027699	12 ft.	ft, 1/10, 1/100 & ft, in, 1/8, 1/16	5/8"	up to 5'	A4
PG1816	004102	16 ft.	ft, in, 1/8, 1/16 (1/32 first 12")	1"	up to 8'	B1
PG1016	004300	16 ft.	ft, 1/10, 1/100	1"	up to 8'	B2
PG18M16	027859	16 ft./5m	ft, in, 1/8, 1/16 & cm, mm	1"	up to 8'	B5
PG18M25	004706	25 ft./7.5m	ft, in, 1/8, 1/16 & cm, mm	1"	up to 8'	B5
PG1825	004010	25 ft.	ft, in, 1/8, 1/16 (1/32 first with 12")	1"	up to 8'	B1
PG1025	004201	25 ft.	ft, 1/10, 1/100	1"	up to 8'	B2
PG181025	010349	25 ft.	ft, 1/10, 1/100 & ft, in, 1/8, 1/16	1"	up to 8'	B4
PG10M25	010356	25 ft./7.5m	ft, 1/10, 1/100 & cm, mm	1"	up to 8'	B6
PG1830	004355	30 ft.	ft, in, 1/8, 1/16 (1/32 first 12")	1"	up to 8'	B1
PG181033	027682	33 ft.	ft, 1/10, 1/100 & ft, in, 1/8, 1/16	1"	up to 8'	B4
PG1835	021994	35 ft.	ft, in, 1/8, 1/16 (1/32 first 12")	1"	up to 8'	B1
PG5M	028245	5 m	m, cm, mm	25mm	up to 8'	B3
PG8M	028252	8 m	m, cm, mm	25mm	up to 8'	B3

*See Pages 70-71

TOGGLE SERIES

PGT_V 19 SKUS, 10 LENGTHS

This high-visibility, Keson-Orange series of tape measures features a toggle locking mechanism. The bright orange color makes these tapes easy to locate. This style remains a classic and is among our most popular. That is why we offer all of our unit options in this style. We even have 3 lengths (our FD sub-series) that break inches out in fractions on one edge of the blade and in decimals on the other edge (see blade B7).

FEATURES < TOGGLE SERIES

- 1. Nylon-Coating** extends life of the blade.
- 2. High-Impact, High-Visibility, Keson-Orange ABS Case** protects the blade and stands up to heavy use.
- 3. No Grip Case** design is simple to hold and slides easily in and out of any containers: tool bucket, bag, leather sheath, even pocket.



PGT1825V

A: 5/8-inch wide, nylon-coated, short tape



A20 = M: cm, mm

B: 1-inch wide, nylon-coated, short tape



B2 = ENG: ft., 1/10, 1/100



B3 = METRIC: cm, mm



B4 = ENG/SAE: ft., 1/10, 1/100 & ft., in., 1/8, 1/16



B5 = SAE/M: ft., in., 1/8, 1/16 & cm, mm

A7 & B7 = Vertical Reading SAE/Dec: ft., in., 1/8, 1/16 & .125, .250, .375, etc.

PRODUCT FEATURES & BENEFITS

Lock	Toggle
Case	High-impact, high visibility ABS
Blade	Nylon-coated steel

MODEL	UPC 052837	LENGTH	UNITS	WIDTH (IN)	STAND OUT (FT)	BLADE*
PGT1810V	027941	10 ft.	ft, in, 1/8, 1/16 (1/32 first 12")	5/8"	up to 5'	A1
PGT18M10V	028009	10 ft./3m	ft, in, 1/8, 1/16 & cm, mm	5/8"	up to 5'	A5
PGT1812V	027958	12 ft.	ft, in, 1/8, 1/16 (1/32 first 12")	5/8"	up to 5'	A1
PGT181012V	027910	12 ft.	ft, 1/10, 1/100 & ft, in, 1/8, 1/16	5/8"	up to 5'	A4
PGT1816V	027965	16 ft.	ft, in, 1/8, 1/16 (1/32 first 12")	1"	up to 8'	B1
PGT18M16V	028016	16 ft./5m	ft, in, 1/8, 1/16 & cm, mm	1"	up to 8'	B5
PGT1825V	027972	25 ft.	ft, in, 1/8, 1/16 (1/32 first 12")	1"	up to 8'	B1
PGT181025V	027927	25 ft.	ft, 1/10, 1/100 & ft, in, 1/8, 1/16	1"	up to 8'	B4
PGT18M25V	028023	26 ft./8m	ft, in, 1/8, 1/16 & cm, mm	1"	up to 8'	B5
PGT1830V	027989	30 ft.	ft, in, 1/8, 1/16 (1/32 first 12")	1"	up to 8'	B1
PGT181033V	027934	33 ft.	ft, 1/10, 1/100 & ft, in, 1/8, 1/16	1"	up to 8'	B4
PGT1033V	028375	33 ft	ft, 1/10, 1/100	1"	up to 8'	B2
PGT1833V	027996	33 ft.	ft, in, 1/8, 1/16 (1/32 first 12")	1"	up to 8'	B1
PGTFD12V	028030	12 ft.	Vertical Reading Fractional (ft, in, 1/8, 1/16) & Decimal (.125, .250, .375, etc.)	5/8"	up to 5'	A7
PGTFD16V	028047	16 ft.	Vertical Reading Fractional (ft, in, 1/8, 1/16) & Decimal (.125, .250, .375, etc.)	1"	up to 8'	B7
PGTFD25V	028054	25 ft.	Vertical Reading Fractional (ft, in, 1/8, 1/16) & Decimal (.125, .250, .375, etc.)	1"	up to 8'	B7
PGT3MV	028269	3 m	m, cm, mm	16mm	up to 8'	A20
PGT5MV	028276	5 m	m, cm, mm	25mm	up to 8'	B3
PGT8MV	028283	8 m	m, cm, mm	25mm	up to 8'	B3

*See Page 70

ULTRA BRIGHT BLADE

PG_UP 6 SKUS, 4 LENGTHS

Our Ultra Bright class of short tape measures are easy to read in low light environments, and stay visually cleaner than black and white blades. Great for in-shadow measurements, for instance, those in cabinets and in corners. Also helpful in the meager light of dawn and of dusk. We've increased the number size to make them easier to read in any condition. We also have added a vertical reading feet and inches scale on the reverse side for vertical measurements.

We placed these high-contrast, large-numbered, blades in a solid-ABS housing that is further protected by rubber casing.

FEATURES < ULTRA BRIGHT SERIES

- 1. Ultra Bright Blades** are easier to read in low light.
- 2. Vertical Scale on the Reverse** makes it easier to measure vertical surfaces.
- 3. Highly Visible Housing** makes it easy to find.



HV = High Visibility

PG1825UB

HV

B: 1-inch wide, nylon-coated, short tape



B31 = SAE: ft., in., 1/8, 1/16



B34 = ENG/SAE: ft., 1/10, 1/100, & ft., in., 1/8, 1/16 (1/32 in. first ft.)



B35 = SAE/M: ft., in., 1/8, 1/16 & cm, mm



B22 = an easy-to-read SAE vertical blade (on all Ultra Bright Blades).

PRODUCT FEATURES & BENEFITS

Blade Special	Ultra Bright Blade coloring with larger numbers	You can read the blade more easily in low light applications				
Blade Return	Impact Absorbing Bumper	Helps protect the end hook on tape return.				
Lock	Slide					
Case	High-Impact black ABS, high-visibility rubber grip	Quality case, easy to spot if dropped				
Blade	Nylon-coated steel					
Impact Durability	High-visibility rubber grip	Holds up to accidental drops				
MODEL	UPC 052837	LENGTH	UNITS	WIDTH (IN)	STAND OUT (FT)	BLADE*
PG1816UB	028306	16 ft.	ft, in, 1/8, 1/16	1	up to 8'	B31 & B22
PG1825UB	028313	25 ft.	ft, in, 1/8, 1/16	1	up to 8'	B31 & B22
PG181025UB	028337	25 ft.	ft, in, 1/10, 1/100 & ft, in, 1/8, 1/16	1	up to 8'	B34 & B22
PG18M25UB	028320	25 ft./7.5m	ft, in, 1/8, 1/16 & cm, mm	1	up to 8'	B35 & B22
PG1830UB	028344	30 ft.	ft, in, 1/8, 1/16	1	up to 8'	B31 & B22
PG181033UB	028351	33 ft.	ft, in, 1/10, 1/100 & ft, in, 1/8, 1/16	1	up to 8'	B34 & B22

*See Page 71

WIDE BLADE

PG_WIDEV 6 SKUS, 4 LENGTHS

Our Wide Blade tapes feature 1 3/16-inch blades. We also printed them with larger numbers so they are easier to read. As with all Wide Blade tapes, they have a longer stand out than a standard 1-inch tape. We also have users who insist that when running ours up a wall (with the attachment on the floor), they travel higher than other wide tapes before falling away.

FEATURES < WIDE BLADE SERIES

- Stand out up to 10'** makes it easier for one person to get the job done.
- Nylon-Coating** extends life of the blade.
- High-Impact, High-Visibility, Keson-Orange ABS Case** with rubber grip protects the blade and stands up to heavy use.



PG1825WIDEV

HV = High Visibility Option

C: 1-3/16-inch wide, nylon-coated, short tape



C1 = SAE: ft., in., 1/8, 1/16 (1/32 in. first ft.)



C4 = ENG/SAE: ft., 1/10, 1/100, & ft., in., 1/8, 1/16 (1/32 in. first ft.)



C5 = SAE/M: ft., in., 1/8, 1/16 & cm, mm

PRODUCT FEATURES & BENEFITS

Lock	Slide					
Case	High-visibility and black ABS	High-visibility rubber grip				
Blade	Nylon-coated steel					
Impact Durability	High-visibility rubber grip	Holds up to accidental drops				
MODEL	UPC 052837	LENGTH	UNITS	WIDTH (IN)	STAND OUT (FT)	BLADE*
PG1825WIDEV	027835	25 ft.	ft, in, 1/8, 1/16 (1/32 first 12")	1-3/16"	up to 10'	C1
PG181025WIDEV	027781	25 ft.	ft, in, 1/10, 1/100 & ft, in, 1/8, 1/16	1-3/16"	up to 10'	C4
PG18M25WIDEV	028436	25 ft./7.5m	ft, in, 1/8, 1/16 & cm, mm	1-3/16"	up to 10'	C5
PG1830WIDEV	028399	30 ft.	ft, in, 1/8, 1/16 (1/32 first 12")	1-3/16"	up to 10'	C1
PG181033WIDEV	028443	33 ft.	ft, in, 1/10, 1/100 & ft, in, 1/8, 1/16	1-3/16"	up to 10'	C4
PG1835WIDEV	028405	35 ft.	ft, in, 1/8, 1/16 (1/32 first 12")	1-3/16"	up to 10'	C1

*See Page 72

AUTOMATIC LOCK

PG_AL, 6 SKUS, 1 LENGTH

Our AutoLock Series is a best seller in offering of tapes. The Automatic Lock features blades that stay out without the user needing to engage a lock. A push button releases the blade and enables it to retract. These tapes come with a rubber grip and are in a compact housing. They are available in a chrome coated or a high-visibility orange ABS case.

FEATURES < AUTO LOCK SERIES

- 1. Automatic Locking Blades** stay out without engaging a lock.
- 2. Nylon-Coating** extends life of the blade.
- 3. Stainless Steel or High-Impact, High Visibility, Keson-Orange ABS Case** with rubber grip protects the blade and stands up to heavy use.



HV PG1825ALV

A: 5/8-inch wide, nylon-coated, short tape

B: 1-inch wide, nylon-coated, short tape



A9 = SAE: ft., in., 1/8, 1/16 (1/32 in. first ft.)



B1 = SAE: ft., in., 1/8, 1/16 (1/32 in. first ft.)



B5 = SAE/M: ft., in., 1/8, 1/16 & cm, mm



B6 = ENG/M: ft., 1/10, 1/100 & cm, mm



B9 = SAE: ft., in., 1/8, 1/16 (1/32 in. first ft.) with Magnetic Tip

HV = High Visibility Option

PRODUCT FEATURES & BENEFITS

Lock	Automatic, button-release	
Case	Chrome-coated ABS/ High-visibility orange ABS	Rubber grip/High visibility
Blade	Nylon-coated steel	
Impact Durability	High-visibility rubber grip	Holds up to accidental drops

MODEL	UPC 052837	LENGTH	UNITS	WIDTH (IN)	STAND OUT (FT)	BLADE*
PG1825AL	027606	25 ft.	ft, in, 1/8, 1/16 (1/32 first 12")	1"	up to 8'	B1
PG18M25AL	027866	25 ft./7.5m	ft, in, 1/8, 1/16 & cm, mm	1"	up to 8'	B5
PG10M25AL	027712	25 ft./7.5m	ft, in, 1/10, 1/100 & cm, mm	1"	up to 8'	B6
PG181025AL	027705	25 ft.	ft, in, 1/10, 1/100 & ft. in, 1/8, 1/16	1"	up to 8'	B4
PG1825ALV	027804	25 ft.	ft, in, 1/8, 1/16 (1/32 first 12")	1"	up to 8'	B1
PG1816ALVMAG	028702	16 ft.	ft, in, 1/8, 1/16 (1/32 first 12")	5/8"	up to 8'	A9

*See Pages 70-71



PROFESSIONAL

PGPRO_ 6 SKUS, 5 LENGTHS

We have two case styles in our Pro Series of tape measures: a stainless or high-impact, high-visibility, Keson-Orange ABS. The entire family features stronger locks than our chrome and toggle series. They also offer our highest impact resistance and feature a slotted rubber grip for a comfortable and slip-resistant hold.

FEATURES < PROFESSIONAL SERIES

- 1. Stainless Components** extend tape life in wet environments.
- 2. Nylon-Coating** extends life of the blade.
- 3. Stainless or High-Impact, High Visibility, Keson-Orange ABS case** with rubber grip protects the blade and stands up to heavy use.

A: 5/8-inch wide, nylon-coated, short tape



A1 = SAE: ft., in., 1/8, 1/16 (1/32 in. first ft.)

B: 1-wide, nylon-coated, short tape inch



B1 = SAE: ft., in., 1/8, 1/16 (1/32 in. first ft.)



HV = High Visibility Option

PRODUCT FEATURES & BENEFITS

Lock	Slide					
Case	Stainless or High visibility orange ABS					Rubber grip/High visibility
Blade	Nylon-coated steel					
Impact Durability	High-visibility rubber grip					Holds up to accidental drops
MODEL	UPC 052837	LENGTH	UNITS	WIDTH (IN)	STAND OUT (FT)	BLADE*
* PGPRO1825	027545	25 ft.	ft, in, 1/8, 1/16 (1/32 first 12")	1"	up to 8'	B1
* PGPRO1830	027552	30 ft.	ft, in, 1/8, 1/16 (1/32 first 12")	1"	up to 8'	B1
PGPRO1812V	027873	12 ft.	ft, in, 1/8, 1/16 (1/32 first 12")	5/8"	up to 4'	A1
PGPRO1816V	027880	16 ft.	ft, in, 1/8, 1/16 (1/32 first 12")	1"	up to 8'	B1
PGPRO1825V	027897	25 ft.	ft, in, 1/8, 1/16 (1/32 first 12")	1"	up to 8'	B1
PGPRO1835V	027903	35 ft.	ft, in, 1/8, 1/16 (1/32 first 12")	1"	up to 8'	B1

* PGPRO1825 and PGPRO1830 while supplies last

*See Page 70



MAGNETIC TIP

PG_MAG 4 SKUS, 4 LENGTHS

The magnetic hook end sticks to attach to any metal surface. Stick it to a metal door frame and you can pace off 10 feet or more. Great for drop ceiling work, steel framing, HVAC, and shop work.

A: 5/8-inch wide, nylon-coated, short tape

B: 1-inch wide, nylon-coated, short tape



FEATURES < MAGNETIC TIP SERIES

- 1. Magnetic Tip** holds fast to metal attachment points.
- 2. Nylon-Coating** extends life of the blade.
- 3. High-Impact, High Visibility, Keson-Orange ABS case** with rubber grip protects the blade and stands up to heavy use.



PRODUCT FEATURES & BENEFITS

Lock	Slide or Button release	
Case	Chrome-coated ABS/High visibility orange ABS	Rubber grip/High visibility
Blade	Nylon-coated steel	
Impact Durability	High-visibility rubber grip	Holds up to accidental drops

MODEL	UPC 052837	LENGTH	UNITS	WIDTH (IN)	STAND OUT (FT)	BLADE*
PG1816ALVMAG	028702	16 ft.	ft, in, 1/8, 1/16 (1/32 first 12")	5/8"	up to 8'	A9
PG1825VMAG	027828	25 ft.	ft, in, 1/8, 1/16 (1/32 first 12")	1"	up to 8'	B9
PG18M26VMAG	028726	26 ft.	ft, in, 1/8, 1/16 & cm, mm	1"	up to 8'	B10
PG1835VMAG	028733	35 ft.	ft, in, 1/8, 1/16 (1/32 first 12")	1"	up to 8'	B9

*See Pages 70-71

ECONOMY SERIES

PG_ 2 SKUs, 1 LENGTH

The co-molded plastic housing holds a lacquer-coated blade with easy to read marking of each eight, quarter and half inch. A side brake will slow or stop the blade return when engaged. A good tape at a very reasonable price.

B: 1-inch wide, lacquer-coated, short tape

FEATURES < ECONOMY SERIES

- 1. Side Brake** slows or stops the blade return when engaged.
- 2. Lacquer Coated** blade.
- 3. High-Impact, High-Visibility, ABS Case** with rubber grip protects the blade and stands up to heavy use.

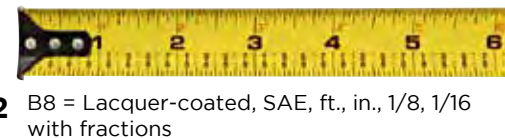
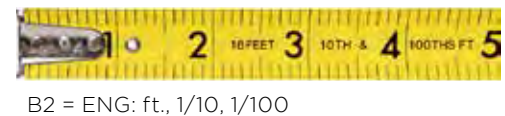

PRODUCT FEATURES & BENEFITS

Lock	Slide	
Case	High-impact, high-visibility ABS with rubber grip	

MODEL	UPC 052837	LENGTH	UNITS	WIDTH (IN)	STAND OUT (FT)	BLADE*
PG25	022076	25 ft.	ft, in, 1/8, 1/16 with fractions	1"	up to 8'	B8
PG2510	026371	25 ft.	ft, 1/10, 1/100	1"	up to 8'	B2

*See Pages 70-71

SPECIALTY MEASURES



KESON KEYCHAIN

Keychain tape measure available in both Feet & Inches as well as Metric measurements. Countertop display box is available.



PG18M6KC



PG186KC

MODEL	UPC 052837	LENGTH	UNITS
PG186KC	028719	6 ft.	ft, in & 1/8
PG18M6KC	028740	6 ft.	m, cm, mm

BRASS EXTENDER

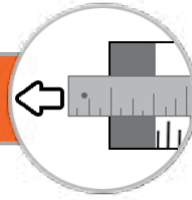

The brass extender makes measuring tight openings a snap. Extends up to 6 inches, and sliding rule stops at each end to resist falling out. A very useful tool for carpenters.

FEATURES < BRASS EXTENDER

1. Six-inch brass extender allows for accurate measuring in tight places.
2. Measures in feet and inches.
3. 1/16-inch graduations.

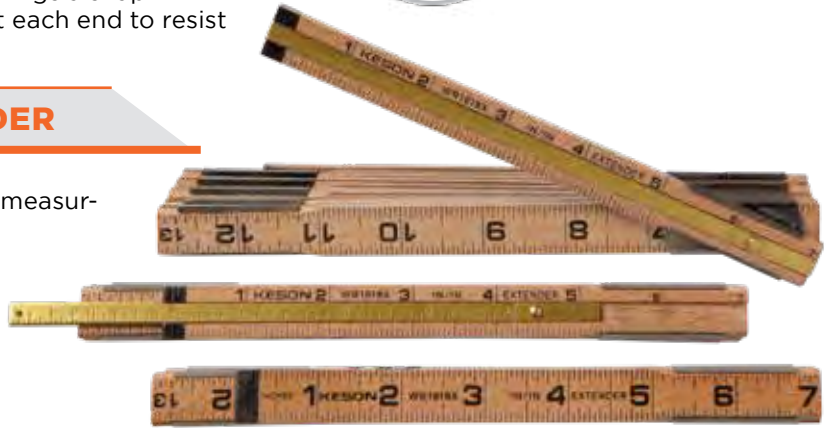

WR1818X

INSIDE READ

This wood ruler has inside marking. Numeration starts on the inside of the rule, so the measurement lies close to the work.

FEATURES < INSIDE READ

1. Measurements are marked on both sides, both edges, graduated to 1/16-inch.
2. Measures in feet and inches.
3. Designed for carpentry and wood-working.



WR1818

ENGINEER'S



Designed for engineer or other measurements requiring tenths and feet. Decimal points on engineer's scale prevent reading errors.

FEATURES < ENGINEER'S

1. Graduated in feet, 10ths and 100ths.
2. Regular outside marking in feet, inches, graduated to 1/16-inch.
3. Engineer's side has foot marks in red, and decimal points.

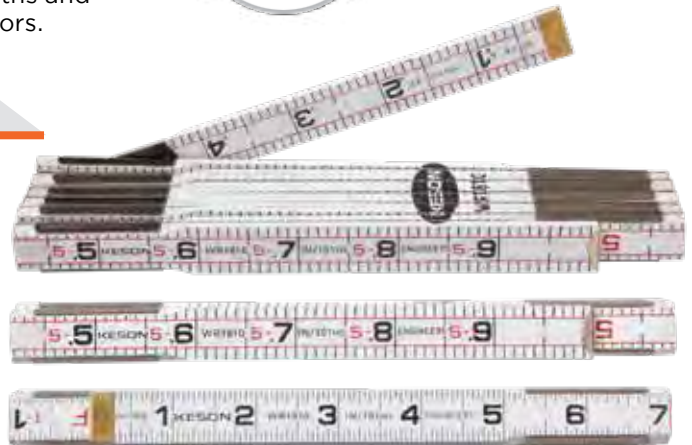

WR1810

METRIC

metric

This 2-meter folding ruler measures in mm, cm, and meter graduations.

FEATURES

1. Measures in mm, cm, m & feet and inches.
2. 2 meter total length.
3. Metric measurements on one side, feet and inches on the other.



WR18M

BRICK MASON



Designed for use in bricklaying and mason's work, with a brick mason's scale on the inside.

FEATURES < BRICK MASON

1. Vertical Brick Mason scale on the inside rule.
2. Measures in feet and inches, graduated to 1/16-inch.
3. High-quality materials, clear protective coating.



WR18BL

MODEL	UPC 052837	LENGTH	UNITS	WIDTH (IN)	MATERIAL	SPECIAL
WR1818X	028511	6 ft.	ft, in & ft, in, with 6 in extender	5/8	Beechwood	Brass Extender
WR1818	028528	6 ft.	ft, in, 1/8, 1/16	5/8	Beechwood	Inside Read
WR1810	028535	6 ft.	ft, in, 1/8, 1/16 & ft, 1/10, 1/100	5/8	Beechwood	Engineer's
WR18M	028559	6.5 ft./2m	ft, in, 1/8, 1/16 & m, cm, mm	5/8	Beechwood	Metric
WR18BL	028542	6 ft.	ft, in & brick mason units	5/8	Beechwood	Brick Mason

DIAMETER TAPES

The diameter of a circular object, like a tree or a pipe, is easily measured using a Keson diameter tape. The tape is calibrated in units of 3.14(pi) inches. The tape is actually measuring the tree or pipe's circumference, but the units on the tape are adjusted by pi enabling you to get a diameter by wrapping this tape around a circular object.

Our PD618 has a stainless steel case which features a reflective surface and textured rubber grip to keep the tape from slipping. Our D18646 features the same blade in a plastic case.

Limited warranty.

MODEL	UPC 052837	LENGTH	WIDTH	UNITS	CASE TYPE	BLADE MATERIAL	BLADE*
D18646	005703	6 ft.	1/4 in.	ft, in, (1/64 first 12") One side: diameter inches to 64ths Other side: blank space before zero	white ABS	steel	D2, D12
PD618	027750	6 ft.	1/4 in.	Side 1 (Top): inches in pi to the 100ths Side 2 (Bottom): continuous ft, in, 1/8/, 1/16	steel	steel	D1, D11

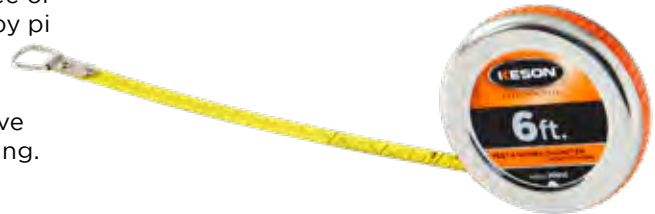

PD618



D18646

POCKET TAPE MEASURES

These small tapes are perfect for carrying in a pocket. The unique arch design of the PG1812SQ enables the tape to slip in and out without catching. It comes with a removable belt clip. The PG1810 has a magnetic back so it can stick to a file cabinet, cubical frame, door frame, or refrigerator.

Limited warranty.

MODEL	UPC 052837	LENGTH	WIDTH	UNITS	CASE TYPE	BLADE MATERIAL	BLADE*
PG10	027596	10 ft.	1/4 in.	ft., in., 1/8, 1/16, 1/4	magnetic back	steel	
PG1812SQ	027798	12 ft.	5/8 in.	ft., in., 1/8, 1/16, (1/32 first 12")	special	steel	A1



PG10

PG1812SQ

POCKET RODS

This 6-1/2 foot vertical-reading leveling rod or grading rod is packed in a compact like a tape measure. It's ideal for checking a grade without having to carry a full-size rod. Great for foundation work, grading, swimming pools and construction photo records. Easy-to-read numbers are printed on both sides.

FEATURES

- Built-in target on 2 sides.
- Nylon coated facing not affected by moisture.
- Non-glare surface.
- Convenient surveyors pole.
- Heavy-duty end hook.

"Markings are clearly visible for photographing. I use it for appraisal work for damaged vehicles. No other product can be seen clearly in pictures while capturing the object behind it."
Damage Appraiser, David

Limited warranty.

MODEL	UPC 052837	LENGTH	UNITS	ZERO PT.
PR610	005208	6.5 ft.	ft. & 10ths	hook end
PR618	005307	6.5 ft.	ft. & in.	hook end
PR2M	020416	2 m	metric	hook end



PR610

PR618

PR2M

SURVEYOR'S ROPE

Makes an ideal drag chain for rough surveying measurements. Numbers are graduated from the strap handle upward to the end of the rope.

FEATURES

- Tough, flexible and lightweight.
- White with black and red markings.
- Coating: Clear Coat.
- Tensile Strength: 100kg / 200 lbs.

Limited warranty.

MODEL	UPC 052837	LENGTH	WIDTH	UNITS	BLADE MATERIAL
SR18100	005505	100 ft.	1/4 in.	ft. & in.	fiberglass
SR10100	005604	100 ft.	1/4 in.	ft. & 10ths	fiberglass
SR18200	005512	200 ft.	1/4 in.	ft. & in.	fiberglass
SR10200	005611	200 ft.	1/4 in.	ft. & 10ths	fiberglass
SR18300	005529	300 ft.	1/4 in.	ft. & in.	fiberglass
SR10300	005628	300 ft.	1/4 in.	ft. & 10ths	fiberglass
SR30M	021772	30 m	6.35mm	metric	fiberglass
SR50M	021789	50 m	6.35mm	metric	fiberglass
SR100M	021802	100 m	6.35mm	metric	fiberglass



SR18300

DEPTH GAUGES

Developed for seismographic measuring, these tough fiberglass tapes are used by a variety of industries to measure depth. Attach any weight to the snap ring and lower to measure depth. The depth gauges are incredibly durable, flexible and lightweight with graduations printed on both sides.

FEATURES

- Numbers are graduated from the weighted end of the tape strap.
- Tough, flexible, and lightweight with graduations printed on both sides.
- White with black and red markings.
- Coating: Clear Coat.
- Tensile Strength: 100kg / 200 lbs.

Limited warranty.

MODEL	UPC 052837	LENGTH	WIDTH	UNITS	BLADE MATERIAL
DG2518	025931	25 ft.	1/4 in.	ft. & in.	fiberglass
DG5018	005406	50 ft.	1/4 in.	ft. & in.	fiberglass
DG10018	005413	100 ft.	1/4 in.	ft. & in.	fiberglass
DG20018	005420	200 ft.	1/4 in.	ft. & in.	fiberglass
DG30018	028184	300 ft.	1/4 in.	ft. & in.	fiberglass
DG15M	026081	15 m	6.35mm	m, dm, cm	fiberglass
DG30M	026098	30 m	6.35mm	m, dm, cm	fiberglass
DG50M	026104	50 m	6.35mm	m, dm, cm	fiberglass



DG20018



WARNING!

Products on this page can expose you to chemicals including DI(2-ETHYLHEXYL) PHTHALATE which is known to the State of California to cause cancer or birth defects or reproductive harm. For more information, visit www.p65Warnings.ca.gov.

MARKING

CHALK LINE
REELS

CHALK

MASON TWINE

PAINT

SPECIALTY
MARKING

FLAGGING &
BARRICADE
TAPE



CHALK LINE REELS

A LITTLE ABOUT CHALK LINE REELS

A chalk line is a very simple tool that performs an essential task: it provides a perfectly straight line that is temporary to almost permanent. The material cost to do this essential task is very reasonable. In fact, once you own the reel, it's almost free.

At Keson, we've taken the time to learn a lot about chalk line reels from end-users. As the only US manufacturer of chalk and chalk line reels, we are in a unique position to interact and respond with the people who build in and build up our communities. These builders have told us a lot about what's important in a chalk line reel, and what works and what doesn't. We continuously add to and improve our chalk and chalk line reels based on the feedback from end-users.

What's more, we offer suppliers the most complete Line Chalking Systems for your customers.

Size Class	Standard				Giant		
							
SKU	K1	P100	K3X	K3XPro	G100, G110 G150BOLD	G3X G3X150BOLD	G130, G150
Chalk Fill Closure	Slide Door	Grommet	BigMouth®	BigMouth®	BigMouth®	BigMouth®	BigMouth®
Line Structure	Twisted	Braided	Twisted	Braided	Braided	Braided	Braided
Line Material	Poly	Poly	Poly	Poly	Poly or Cotton	Poly	Poly or Cotton
Line Thickness	Standard	Bold	Standard	Precision	Giant Bold	Giant Bold	Giant
Page No.	56	57	56	55	58 57	58 57	58

CAPACITY The more chalk you can functionally put into a CLR, the more snaps you can get per fill up.

Standard: K1: 2 oz
P100, K3X, K3XPro: 3 to 3.5 oz

Giants: Little Giants: 12 - 16 oz
Giants: 24 - 27 oz

CHALK FILL CLOSURE All Keson CLR's use a BigMouth® Grommet (except the K1). Two advantages of a grommet: openings are round, just like the openings for chalk bottles, and the grommet is an easy open and securely close system. Slide doors are rectangular, and can accidentally slide open.

Rectangle Slide: K1
Small BigMouth®: K3X, K3XPro
BigMouth®: G100, G110, G150BOLD, G3X, G3X150BOLD, G130, G150

GEAR RATIO The higher the gear ratio, the faster you can reel in a chalk line. As chalk lines are pulled from the reel, and as they are retrieved, the string comes into contact with the chalk inside the reel. This is what coats it for the next strike. Go out or come in too fast, and you are missing the opportunity to fully coat your line. Also, too rapidly bringing in a line can cause jams and string twisting.

1X 100 feet in about 60 seconds
Rewind: 30 feet in about 15 seconds

3X 100 feet in about 25 seconds
Rewind: 30 feet in about 10 seconds

LINE STRUCTURE How a string is put together determines how much chalk a line holds and how much chalk a line lays down. Strings of the same diameter and material perform differently based on their structure.

Twisted:

Economical
Picks up more chalk
Puts down more chalk
Stronger than braided

Braided:

Uses less chalk
Puts down less chalk
with less ghosting











LINE MATERIAL What a string is made of impacts how much chalk a line holds and how much chalk a line lays down. Strings of the same diameter and structure perform differently based on their material.

Natural (Cotton):

Picks up more chalk
Puts down more chalk
Will mildew and weaken
in damp environments

Synthetic (Poly):

Picks up less chalk
Puts down less chalk
Lasts longer, stronger,
more durable, and dampness does not affect

String Thickness	Precision	Standard	BOLD	GIANT
Width of snapped line	<0.99mm 	1.00-1.25mm 	1.26-2.00mm 	>2.00mm 
1X SKUS		 K1	 P100, G150BOLD (formerly G140FL)	 G100, G110 G130, G150 G100C G150C
3X SKUS	 MADE IN USA	 MADE IN USA	 MADE IN USA	 MADE IN USA
	K3XPro	K3X	G3X150BOLD	G3X

**LINE THICKNESS:
PRECISION**

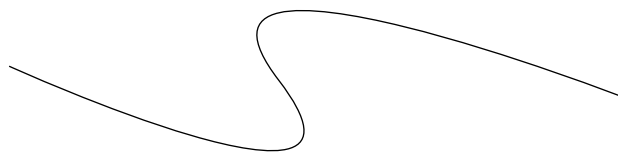

Precision chalk lines leave a line like that of a mechanical pencil. This synthetic, braided line does not pick up a lot of chalk when exiting the reel. When it's snapped, there is not a lot of over spray or ghosting around the line.

FEATURES < PRECISION STRING

K3XPRO

1. **BigMouth® chalk port** for easy fill up and also ensures a protected seal.
2. **Flush handle and patented wedge shape** enables easy in and out of tool pouch.
3. **3X rewind with clutch release** for fast line pay out and retrieval.
4. **Metal rewind arm and tough ABS case**
5. **Oversize hook holds true**
6. **Made in the USA**

APPLICATIONS

Indoor work, fine woodworking, cabinetry, tile, mosaic work



K3XPRO

MODEL	UPC 052837	HOUSING	LENGTH	CAPACITY	SPECIAL
K3XPRO	028641	AL/ABS	100 ft	2 oz	3:1

Measuring Wheels

Levels

Long Tapes

Short Tapes

Specialty Measures

Chalk Line Reels

Chalk

Twine/Paint

Specialty Marking

Flagging Tape Etc.

**LINE THICKNESS:
STANDARD**

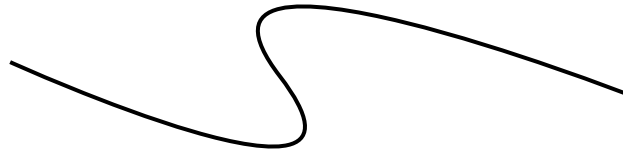
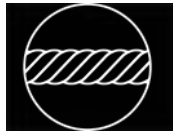

Most popular & the original offering.

Standard lines are similar in size to a felt tip pen line. Our twisted synthetic line picks up and puts down more chalk than our precision line. There is a bit of overspray on the lines.

FEATURES < STANDARD STRING

K1

1. **Compact and Light**
2. **Self-sealing grommet** for spill-free refills.
3. **Slide Door** for refills



K3X

1. **BigMouth® chalk port** for easy fill up and a sure, protected seal.
2. **Flush handle and patented wedge shape** enables easy in and out of tool pouch.
3. **3X rewind with clutch release** for fast line pay out and retrieval.
4. **Metal rewind arm** and tough ABS case.
5. **Made in the USA**



MODEL	UPC 052837	HOUSING	LENGTH	CAPACITY	SPECIAL
* K1	022656	AL	100 ft	2-3 oz	1:1
K3X	028597	ABS	100 ft	2-3 oz	3:1

* Combo/Sets Available

800.345.3766 • FAX 800.345.8849 • WWW.KESON.COM • SALESORDERS@KESON.COM

**LINE THICKNESS:
BOLD**

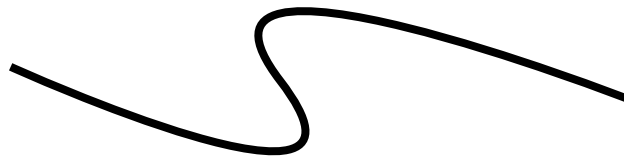

Our bold string leaves lines a little larger than a felt-tip, but not quite a Sharpie. This string is more often used in higher traffic areas and outdoors.

FEATURES < BOLD STRING

P100

1. **Unique shape** great for corner work.
2. **Heavy-duty steel crank** for long life.
3. **Holds 3 oz. of chalk**
4. **100 feet** bold string.



P100

G150BOLD (substitutes for G140FL)

1. **Holds almost 1 pound of chalk** for fewer refills.
2. **BigMouth® chalk port** for easy fill up and a sure, protected seal.
3. **150 feet** bold string, and pull ring.
4. **One-piece steel crank handle** for long life.



G150BOLD

G3X150BOLD

1. **Ergonomic, glovable grip** designed to reduce wrist strain.
2. **BigMouth® chalk port** for easy fill up and a sure, protected seal.
3. **12 ounce capacity**
4. **3X rewind** for fast line pay out and retrieval.



G3X150BOLD

MODEL	UPC 052837	HOUSING	HANDLE	LENGTH	CAPACITY	SPECIAL
P100	023486	ABS	METAL	100 ft	2-4 oz	1:1
G150BOLD	028689	ABS	METAL	100 ft	12 oz	1:1
G3X150BOLD	028672	ABS	METAL	100 ft	12 oz	3:1

**LINE THICKNESS:
GIANT**

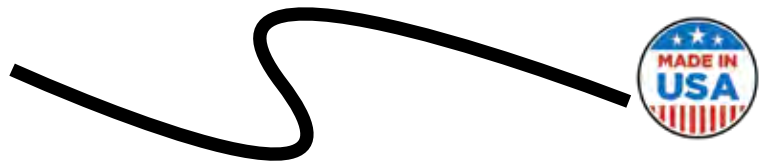

Our giant string leaves huge bold lines. Often used in parking lots, on streets, and on concrete, the Giant lines are easy to see.

FEATURES < GIANT STRING

G100

1. Holds almost 1 pound of chalk for fewer refills.
2. **BigMouth®** chalk port for easy fill up and a sure, protected seal.
3. 100 feet giant string, and pull ring.
4. One-piece steel crank for long life.



G150

1. Holds over 1 pound of chalk for fewer refills.
2. 150 feet giant string, and pull ring.
3. One-piece steel crank for long life.



G3X

1. Ergonomic, glovable grip designed to reduce wrist strain.
2. 12 ounce capacity
3. 3X rewind for fast line pay out and retrieval.



MODEL	UPC 052837	HOUSING	HANDLE	LENGTH	CAPACITY	SPECIAL
* G100	020089	ABS	Metal	100 ft	12 oz	1:1
G110	021895	ABS	Metal	110 ft	12 oz	1:1
G110D	023882	ABS	Metal	110 ft	12 oz X2	2 boxes
* G100C	026418	ABS	Metal	100 ft	12 oz	1:1
G130	005864	ABS	Metal	130 ft	24 oz	1:1
G150	021901	ABS	Metal	150 ft	24 oz	1:1
G150C	026777	ABS	Metal	150 ft	24 oz	1:1
G3X	028498	ABS	ABS	100 ft	12 oz	3:1
G3X100	026432	ABS	ABS	100 ft	12 oz	3:1

* Combo/Sets Available



A LITTLE ABOUT PROCHALK®

ALL MARKING CHALK IS NOT CREATED EQUAL

Keson is the only company making marking chalk in the United States. We have formulated our colors to meet the diverse needs of our customers. The color and the amount of the pigment determines the vividness and permanence of the line. We believe we have created the best marking chalk in the world. It sticks to your line until you decide you want it to stick to something else. Over the years, we've fine-tuned our formulas to produce chalk that performs with consistent excellence, batch after batch.

FIVE LEVELS OF INTENSITY

We've engineered a range of colors with five variations of intensity.

ProChalk Standard for your basic chalk line needs that are easier to clean up or let wear away naturally.

ProChalk High Visibility which include our Glo-Orange, Glo-Lime and Yellow formulations for highly visible applications that will wear or wash away naturally in a few days.

ProChalk Semi-Permanent for weather- and water-resistant lines that hit and stick for a long time but will eventually wear away naturally.

ProChalk Permanent for weatherproof and waterproof lines that aren't going to go away any time soon. Most users are choosing this level of intensity for applications that are going to be covered. This level is engineered for more extreme conditions.

ProChalk Ultimate Dye which is almost 100% pigment for lines that are intended will be laid down once. Period.



Permanency	Standard		High-Visibility			Semi-Permanent		Permanent			Ultimate Dye	
Colors	Blue	White	Lime	Orange	Yellow	Black	Red	Black	Blue	Red	Blue	Red
Permanence Rank	1		2			3		4			5	
Best for	Interior/ Exterior		Exterior			Exterior		Exterior			Exterior	
Applications Include:	Interior Layout, Roofing, Siding, Paneling		Corrections, Plumbing, Electrical, Roofing, Masonry			Exterior Layout, Concrete Layout, Roofing, metal Fabrication		Exterior Layout, Concrete Layout, Extreme Conditions, Long- Term Applications			Exterior Layout, Concrete Layout, Extreme Conditions, Long- Term Applications	

⚠️ WARNING!

This product (ProChalk) can expose you to chemicals including CRYSTALLINE SILICA and/or CARBON BLACK or FORMALDEHYDE which is known to the State of California to cause cancer or birth defects or reproductive harm. For more information, visit www.p65Warnings.ca.gov.

PROCHALK® STANDARD

INTERIOR OR EXTERIOR USE

Applications include interior layout, as well as roofing, siding, and concrete. For interior or exterior use.

1 2 3 4 5
Performance Ranking

MODEL	UPC 052837	COLOR	WEIGHT	SPECIAL FEATURES
8B	006120	blue	8 oz.	Best seller!
8W	006113	white	8 oz.	
103B	020584	blue	3 lbs	
105B	006328	blue	5 lbs.	
105W	006311	white	5 lbs.	
125B	006526	blue	25 lbs.	
125W	006519	white	25 lbs.	Best seller!
148B	006625	blue	48 lbs.	
148W	006618	white	48 lbs.	Best seller!



PROCHALK® HIGH VISIBILITY

STRIKE ONCE, STRIKE BOLD!

Exterior applications include plumbing, electrical, roofing, and masonry.

1 **2** 3 4 5
Performance Ranking

MODEL	UPC 052837	COLOR	WEIGHT	SPECIAL FEATURES
8GL	006427	glo-lime	8 oz.	Glo-color!
8GO	006403	glo-orange	8 oz.	Glo-color!
8Y	006137	yellow	8 oz.	Glo-color!
103GO	020591	glo-orange	3 lbs.	Glo-color!
105GL	020188	glo-lime	5 lbs.	Glo-color!
105GO	006410	glo-orange	5 lbs.	Glo-color!
105Y	006335	yellow	5 lbs.	Glo-color!
125GO	006540	glo-orange	25 lbs.	Glo-color!
125Y	006533	yellow	25 lbs.	Glo-color!
148GO	006649	glo-orange	48 lbs.	Glo-color!
148Y	006632	yellow	48 lbs.	Glo-color!



PROCHALK® SEMI-PERMANENT

MARKING CHALK WATERPROOF

Exterior applications include concrete layout, roofing, metal fabrication.



MODEL	UPC 052837	COLOR	WEIGHT	SPECIAL FEATURES
8BLACK	025954	black	8 oz.	
8R	006106	red	8 oz.	
103BLACK	026203	black	3 lbs.	
103R	020577	red	3 lbs.	Best seller!
105BLACK	026210	black	5 lbs.	
105R	006304	red	5 lbs.	Best seller!
125R	006502	red	25 lbs.	
148R	006601	red	48 lbs.	



PROCHALK® PERMANENT

WEATHERPROOF MARKING

Exterior applications include exterior layout, extreme conditions, concrete layout, long-term applications.



MODEL	UPC 052837	COLOR	WEIGHT	SPECIAL FEATURES
PM8BLACK	021482	black	8 oz.	waterproof
PM8BLUE	021505	blue	8 oz.	waterproof
PM8RED	021529	red	8 oz.	waterproof
PM103BLACK	021499	black	3 lbs.	waterproof
PM103BLUE	021512	blue	3 lbs.	waterproof
PM103RED	021536	red	3 lbs.	waterproof
PM105BLACK	025299	black	5 lbs.	waterproof
PM105BLUE	025688	blue	5 lbs.	waterproof
PM105RED	025695	red	5 lbs.	waterproof



These are concentrated marking products. Lines snapped with ProChalk Semi-Permanent, Permanent, and Ultimate Dye grades may be visible as long as one year after striking. The colors also may bleed through light-colored paint.

PROCHALK® ULTIMATE DYE WATERPROOF PERMANENT

Exterior applications include concrete layout, exterior layout, extreme conditions, long-term applications.



1 2 3 4 **5**
Performance Ranking

MODEL	UPC 052837	COLOR	WEIGHT	SPECIAL FEATURES
5BD	025916	blue	5 oz.	chalk-dye
5RD	026838	red	5 oz.	chalk-dye
5BLACKD		black	5 oz.	chalk-dye
103BD	026036	blue	3 lbs.	chalk-dye
103RD	026856	red	3 lbs.	chalk-dye
103BLACKD		black	3 lbs.	chalk-dye



Keson is proud to be a partner with TroopsDirect in its mission of helping American service members. We regularly donate pallets of glo orange and blue chalk to our troops in Afghanistan. Troops use the donation for marking and identifying IED lanes by temporarily discoloring their location with marking chalk, which allows troops and local residents to pass safely.

MASON TWINE

BRAIDED MASON TWINE

Braided twine doesn't come apart even when reused. It is perfect for large jobs and everyday use. You can also nick it with a trowel and it won't unwind. Another benefit is that braided twine does not spin as much as a twisted line, bringing plumb bobs to rest sooner.

FEATURES

- 18-gauge line with an approximate tensile strength of 155 pounds.
- 250 feet = 1/4 pound, 500 feet = 1/2 pound, 1,000 feet = 1 pound.



MODEL	UPC 052837	COLOR	LENGTH
BWB250	020478	black & white	250 ft.
BWB500	020485	black & white	500 ft.
BWB1000	020492	black & white	1000 ft.
GB250	008278	green	250 ft.
GB500	008285	green	500 ft.
GB1000	008292	green	1000 ft.
OB250	008216	orange	250 ft.
OB500	008223	orange	500 ft.
OB1000	008230	orange	1000 ft.

MODEL	UPC 052837	COLOR	LENGTH
PB250	008247	pink	250 ft.
PB500	008254	pink	500 ft.
PB1000	008261	pink	1000 ft.
WB250	108152	white	250 ft.
WB500	108169	white	500 ft.
WB1000	108176	white	1000 ft.
YB250	108183	yellow	250 ft.
YB500	008193	yellow	500 ft.
YB1000	008209	yellow	1000 ft.

TWISTED MASON TWINE

Twisted line is a fine choice for mason line and other marking needs. Choosing twisted line is often an economical choice. You get 10% more line per spool.

FEATURES

- 18-gauge line with an approximate tensile strength of 160 pounds.
- 275 feet = 1/4 pound, 545 feet = 1/2 pound, 1,090 feet = 1 pound.



MODEL	UPC 052837	COLOR	LENGTH
GT275	108121	green	275 ft.
GT545	008131	green	545 ft.
GT1090	108145	green	1090 ft.
OT275	008063	orange	275 ft.
OT545	008070	orange	545 ft.
OT1090	008087	orange	1090 ft.
PT275	008094	pink	275 ft.
PT545	108107	pink	545 ft.
PT1090	008117	pink	1090 ft.

MODEL	UPC 052837	COLOR	LENGTH
WT275	008001	white	275 ft.
WT545	008018	white	545 ft.
WT1090	008025	white	1090 ft.
YT275	008032	yellow	275 ft.
YT545	008049	yellow	545 ft.
YT1090	008056	yellow	1090 ft.

PAINT



ULTRA-MARK® PAINT

Formulated to generate superior brilliance for long-range visibility. Before marking a dark surface, spray a coat of white to enhance the brightness of the paint. The Ultra-Mark spray paint contains no fluorocarbons, making it non-toxic after drying. Top discharge valve for ease of use. All Keson paint is water based.

Use with **PA14**, **PA35**, **RRPA18** and **RRPA182** applicators (see page 17).

HOW MUCH IS ENOUGH?

A 16-ounce can provides approx. 250 feet of a 4-inch wide line. A 20-ounce can covers approx. 300 feet with the same 4-inch line.

How much Paint is in the can? Compare the Net Weights.

Federal law requires that the cans clearly label the net weight of paint.

20 ounce cans =

Keson: 17 oz. of paint + 3 oz. of propellant (for 16 oz. cans it's 14:2)

Most Competitors: 15 - 16 oz. of paint + 4 or 5 oz. of propellant (for their 16 oz. cans it's 13:3)

100% of Keson paint is made in the USA.

Shelf life of a can of paint is approximately 1 year.

UNIFORM COLOR CODE		
	WHITE	Proposed Excavation
	PINK	Temporary Survey Markings
	RED	Electric Power Lines, Cables, Conduit & Lighting Cables
	YELLOW	Gas, Oil, Steam, Petroleum or Gaseous Materials
	ORANGE	Communication, Alarm or Signal Lines, Cables or Conduit
	BLUE	Potable Water
	GREEN	Sewers and Drain Lines

MODEL	UPC 052837	WEIGHT	COLOR
SP16B	009053	16 oz.	blue
SP16G	009046	16 oz.	green
SP16RO	009015	16 oz.	red-orange
SP16W	009176	16 oz.	white
SP20B	009145	20 oz.	blue
SP20BK	021970	20 oz.	black
SP20G	009169	20 oz.	green
SP20GO	021963	20 oz.	glo-orange
SP20GP	009121	20 oz.	glo-pink
SP20R	009138	20 oz.	red
SP20RO	009114	20 oz.	red orange
SP20W	021956	20 oz.	white
SP20Y	009152	20 oz.	yellow
CS16	020553	16 oz.	clear
CS20	009077	20 oz.	clear



20 oz.

16 oz.

16 or 20 oz.

CHALK LINE SAVER

CLEAR SPRAY WITH INVERTED TIP WHY CHALK LINE SAVER?

Clear spray protects chalk line from wind, rain, and shuffling feet. Save hours of rework by protecting your layout!

PAINT APPLICATORS

Measure and mark simultaneously with RRPA18 and RRPA182.

See full information on page 17.

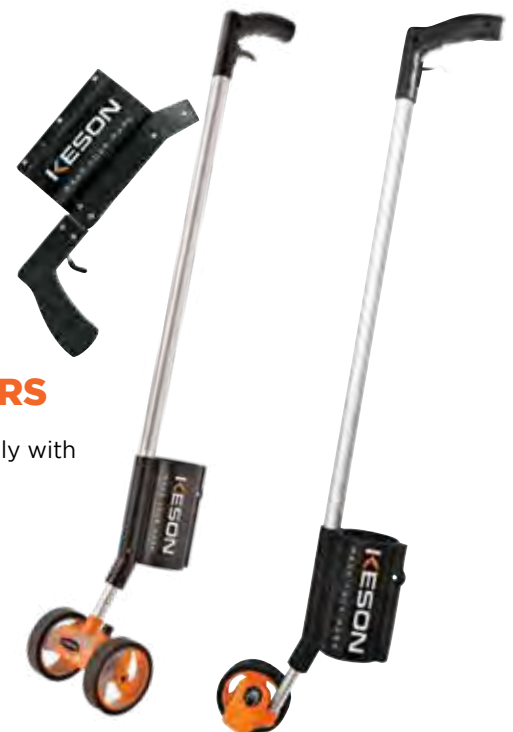

⚠️ WARNING!

This product (ULTRA-MARK PAINT) can expose you to chemicals including Ethylbenzene (100-41-4) which is known to the State of California to cause cancer and Toluene (108-88-3) (Chalk Line Saver) which is known to cause reproductive harm. For more information, visit www.p65Warnings.ca.gov.

SPECIALTY MARKING

VALVE PAINT MARKERS (PAINT PENS)

WHY VALVE PAINT MARKERS (aka PAINT PENS)?

- Marks on all surfaces: metal, wood, glass, plastic, rubber, cardboard and paper.



MODEL	UPC 052837	COLOR	TYPE
VPMB	023660	blue	Valve paint marker/paint pen
VPMBK	023677	black	
VPMR	023684	red	
VPMW	023653	white	
VPMY	023646	yellow	

HARD LUMBER CRAYONS AND HOLDERS

Ideal for warmer climates, and for marking on dry and wet wood, paper, cartons, stone, concrete, tiles, and plastic. Weather and wear resistant.



MODEL	UPC 052837	COLOR
LCBlack	009237	black
LCBlue	009220	blue
LCGPink	021314	glo pink
LCRed	009206	red
LCWhite	009213	white
LCYellow	009251	yellow
PS100	008124	

CARPENTER PENCILS



MODEL	UPC 052837	SPECIAL FEATURES
LP72	007905	Black lead
LP72R	020560	Red lead
LP72WHITE	007736	White wood, black lead

CHINA MARKERS



MODEL	UPC 052837	COLOR	SPECIAL FEATURES
CMBBULK	023790	blue	Available only in bulk
CMBKBULK	023806	black	
CMYBULK	023776	yellow	

HALF-MOON MARKING CHALK

Used on rail cars, concrete, asphalt, wood and other surfaces, this chalk is ideal for layout work and marking for estimating.



MODEL	UPC 052837	COLOR	SPECIAL FEATURES
HMBULKW	024223	white	Half-moon

SOAPSTONE

Keson soapstone is primarily used by welders for metal marking or by plumbers for pipe marking.

Use Keson Chalk Line Saver (p. 43) to make the mark last.



MODEL	UPC 052837	COLOR	SPECIAL FEATURES
SS144BULK	024230	white	Soapstone
SH500	024247	NA	Soapstone holder
SS3H	023592	white	3 pieces of soapstone with holder

FLAGGING & BARRICADE TAPE

BARRICADE TAPE

PROFESSIONAL - 3" WIDE

High-strength, high-visibility barricade tape is manufactured with a superior quality, virgin, yellow opaque poly-material. It is printed with ultra-bond, jet black ink that penetrates the plastic surface. It is scratch-proof and weather-resistant.

MODEL	UPC 052837	COLOR	LENGTH	LEGEND
BT1200E	026548	yellow	1,000 ft.	caution, caution, caution
BT1211	007653	yellow	1,000 ft.	caution: cuidado
BT1214	010226	red	1,000 ft.	danger, danger
BT300	007660	yellow	300 ft.	caution, caution, caution
BT511	84174904792-1	yellow	500 ft.	caution, cuidado)
BT514	84174905213-4	red	500 ft.	danger



FLAGGING TAPE

1-3/16" WIDE - BOXED

MODEL	UPC 052837	LENGTH	COLOR
FTGL	006823	150 ft.	glo-lime
FTGO	006809	150 ft.	glo-orange
FTGP	006830	150 ft.	glo-pink
FTGR	006816	150 ft.	glo-red
FTB	006731	300 ft.	blue
FTG	010646	300 ft.	green
FTO	006717	300 ft.	orange
FTP	010653	300 ft.	pink
FTR	006700	300 ft.	red
FTW	006748	300 ft.	white
FTY	006724	300 ft.	yellow



FLOURESCENT

⚠️ WARNING!

Products on this page can expose you to chemicals including DI(2-ETHYLHEXYL) PHTHALATE which is known to the State of California to cause cancer or birth defects or reproductive harm. For more information, visit www.p65Warnings.ca.gov.

FOIL UNDERGROUND DETECTABLE TAPE

PERMANENT MESSAGE

Color band and black ink imprint are encapsulated in the tape. Ink does not extend to edges, giving maximum bond between plies.

ALUMINUM CORE

A solid detectable core makes it the choice for locating nonmetallic lines.

DURABLE

Constructed with prime resin, it's durable. Tolerates -94° F to 200° F temperature range.

ENDORSED

Meets OSHA regulation 1926-956 (C) (I) covering location of underground utility lines.



MODEL	UPC 052837	COLOR	LENGTH	LEGEND	WIDTH
FDT2BEL	022939	red	1,000 ft.	electric line	2 in.
FDT2BFOL	023080	orange	1,000 ft.	fiber optic line	2 in.
FDT2BGL	022991	yellow	1,000 ft.	gas line	2 in.
FDT2BSL	023110	green	1,000 ft.	sewer line	2 in.
FDT2BWL	023059	blue	1,000 ft.	water line	2 in.
FDT3BEL	022946	red	1,000 ft.	electric line	3 in.
FDT3BFOL	023080	orange	1,000 ft.	fiber optic line	3 in.
FDT3BGL	023004	yellow	1,000 ft.	gas line	3 in.
FDT3BSL	023127	green	1,000 ft.	sewer line	3 in.
FDT3BWL	023066	blue	1,000 ft.	water line	3 in.
FDT6BEL	022953	red	1,000 ft.	electric line	6 in.

SURVEYOR STAKE FLAGS

2-1/2" X 3-1/2" FLAGS ON A 21" STAKE

MODEL	UPC 052837	COLOR	BUNDLE
STK21B	010288	blue	100
STK21G	010301	green	100
STK21GL	010264	glo-lime	100
STK21GO	010240	glo-orange	100
STK21GP	010271	glo-pink	100
STK21GR	010257	glo-red	100
STK21W	006977	white	100
STK21Y	010295	yellow	100



! WARNING!

Products on this page can expose you to chemicals including DI(2-ETHYLHEXYL) PHTHALATE which is known to the State of California to cause cancer or birth defects or reproductive harm. For more information, visit www.p65Warnings.ca.gov.

E = 3/8-inch wide, 2x nylon coated steel, long tape



E1 = Hook, Zero = Hook end, SAE: ft., in., 1/8

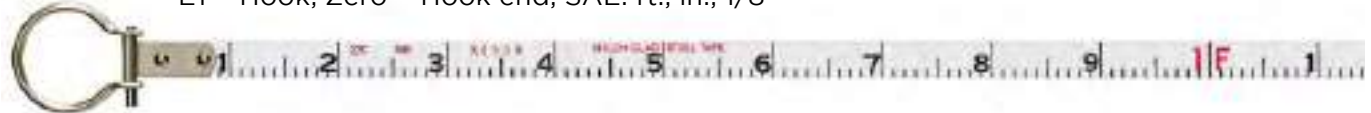

E2 = Ring, Zero = Tape end, ENG: ft., 1/10, 1/100



E3 = Hook, Zero = Hook end, Metric: cm, mm



E15 = Double Hook, Zero = Hook end, SAE (Black and Red)/Metric (Red): ft., in., 1/8 & cm, mm



E17 = Ring, Zero = Tape end + .3 meters, Metric: cm, mm



E19 = Ring, Zero = Tape end + 1 foot, ENG: ft., 1/10, 1/100



E22 = Hook, Zero = Hook end, ENG: ft., 1/10, 1/100



E23 = Ring, Zero = Tape end, Metric: cm, mm

G = 3/8-inch, lacquer-coated steel, long tape



G1 = Hook, Zero = Hook end, SAE: ft., in., 1/8



G2 = Hook, Zero = Hook end, ENG: ft., 1/10, 1/100

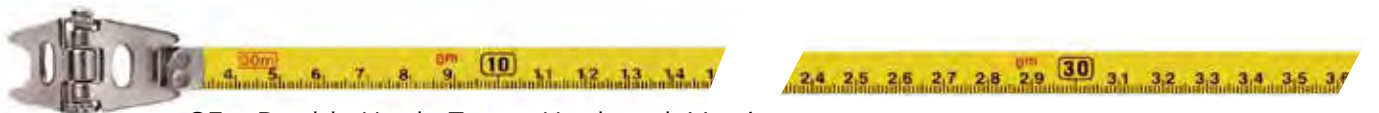

G3 = Double Hook, Zero = Hook end, Metric: cm, mm

F = 1/2-inch wide, fiberglass, long tape



F1 = Hook, Zero = Hook end, SAE: ft., in., 1/8



F2 = Hook, Zero = Hook end, ENG: ft., 1/10, 1/100



F3 = Hook, Zero = Hook end, Metric: cm, 2mm



F12 = Hook, Zero = Hook end, Metric: cm, 5mm



F13 = Hook, Zero = Hook end, Metric (YELLOW): cm, 2mm



F14 = Hook, Zero = Hook end, ENG (YELLOW): ft., 1/10, 1/100



F20 (front view) = Ring, Zero = Tape end, SAE: ft., in., 1/8



F20 (back view) = Ring, Zero = Tape end, ENG (YELLOW): ft., 1/10, 1/100



F31 = Hook, Zero = Hook end, SAE: ft., in., 1/8



F32 = Hook, Zero = Hook end, ENG: ft., 1/10, 1/100



F43 = Hook, Zero = Hook end, Metric (YELLOW): cm, 2mm



F44 = Hook, Zero = Hook end, ENG (YELLOW): ft., 1/10, 1/100

A = 5/8-inch wide, nylon-coated, short tape



A1 = SAE: ft., in., 1/8, 1/16 (1/32 first ft.)



A2 = ENG: ft., 1/10, 1/100



A4 = ENG/SAE: ft., 1/10, 1/100 & ft., in., 1/8, 1/16



A5 = SAE/M: ft., in., 1/8, 1/16 & cm, mm



A7 = Vertical Reading Fractional (ft., in., 1/8, 1/16) & Decimal (.125, .250, .375, etc.)



A9 = SAE: ft., in., 1/8, 1/16 (1/32 first ft.)



A20 = Metric, m, cm, mm

B = 1-inch wide, nylon-coated, short tape



B1 = SAE: ft., in., 1/8, 1/16 (1/32 in. first ft.)



B2 = ENG: ft., 1/10, 1/100



B3 = Lacquer-coated, Metric: cm, mm



B4 = ENG/SAE: ft., 1/10, 1/100 & ft., in., 1/8, 1/16



B5 = SAE/M: ft., in., 1/8, 1/16 & cm, mm

B = 1-inch wide, nylon-coated, short tape (con't.)

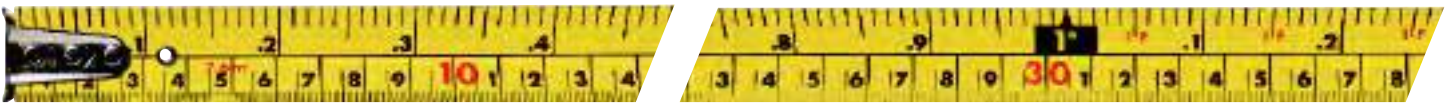

B6 = ENG/M: ft., 1/10, 1/100 & cm, mm

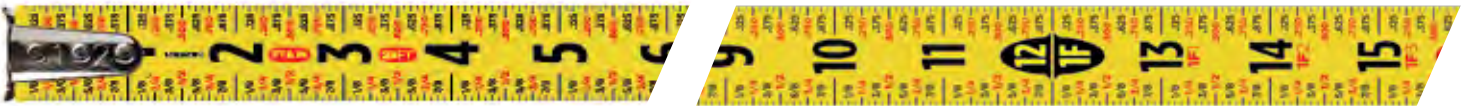

B7 = Vertical Reading Fractional (ft., in., 1/8, 1/16) & Decimal (.125, .250, .375, etc.)



B8 = Lacquer-coated, SAE: ft., in., 1/8, 1/16 with fractions

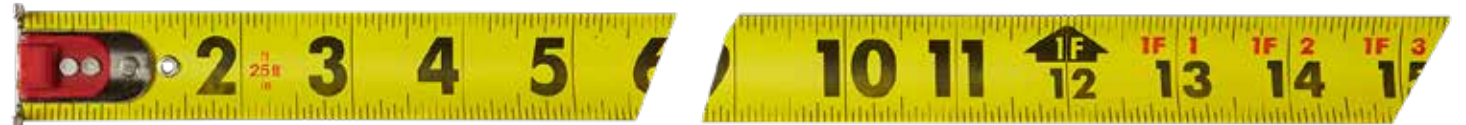

B9 = Magnet, SAE: ft., in., 1/8, 1/16 (1/32 in. first ft.)



B10 = Lacquer-coated, SAE/M: ft., in., 1/8, 1/16 & cm, mm



B18 = Lacquer-coated, SAE, ft., in., 1/8, 1/16



B20 = Metric, m, cm, mm



B22 = Vertical Reading, SAE: ft., in., 1/8, 1/16 (1/32 in. first ft.)



B31 = Ultra Bright, SAE: ft., in., 1/8, 1/16



B34 = Ultra Bright, ENG/SAE: ft., 1/10, 1/100 & ft., in., 1/8, 1/16



B35 = Ultra Bright, SAE/m: ft., in., 1/8, 1/16 & cm, mm

C = 1-3/16 inch wide, nylon-coated, short tape

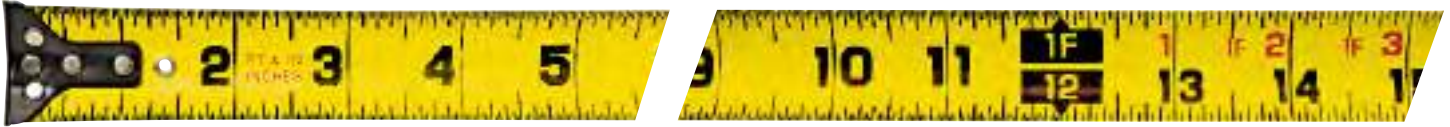

C1 = SAE: ft., in., 1/8, 1/16 (1/32 in. first ft.)



C4 = ENG/SAE: ft., 1/10, 1/100 & ft., in., 1/8, 1/16



C5 = SAE/M: ft., in., 1/8, 1/16 & cm, mm

D = 1/4-inch wide, lacquer-coated pocket tape



D1 = SAE: ft., in., 1/8, 1/16



D11 = diameter inches to the 100th



D2 = SAE: ft., in., 1/8, 1/16



D12 = diameter inches to the 64th

103B.....	60	FDT2BSL.....	67	LKB48.....	22	NR18200.....	31
103BD.....	62	FDT2BWL.....	67	LKB48M.....	23	NR30M.....	31
103BLACK.....	61	FDT3BEL.....	67	LKB72.....	22	NR30ME.....	31
103BLACKD.....	62	FDT3BFOL.....	67	LKB72M.....	23	NR30MH.....	31
103GO.....	60	FDT3BGL.....	67	LKB78.....	22	NR50M.....	31
103R.....	61	FDT3BSL.....	67	LKB7832.....	22	NR50ME.....	31
103RD.....	62	FDT3BWL.....	67	LKB7832M.....	23	NR50MH.....	31
105B.....	60	FDT6BEL.....	67	LKB78M.....	23	NR60M.....	31
105BLACK.....	61	FLT10165.....	34	LKB96.....	22	NR60ME.....	31
105GL.....	60	FLT10200.....	34	LKB24D.....	24	NR60MH.....	31
105GO.....	60	FLT1810200.....	34	LKB48D.....	24	NRS100M.....	30
105R.....	61	FLT18165.....	34	LKB48DM.....	24	NRS10100H.....	30
105W.....	60	FLT18200.....	34	LKGOM.....	27	NRS10200H.....	30
105Y.....	60	FLT18M165.....	34	LKI24.....	25	NRS10300H.....	30
125B.....	60	FLT18M200.....	34	LKI48.....	25	NRS18100.....	30
125GO.....	60	FLT50MM.....	34	LKI72.....	25	NRS18200.....	30
125R.....	61	FTB.....	66	LKL3.....	27	NRS18300.....	30
125W.....	60	FTG.....	66	LKS118.....	26	NRS18M100.....	30
125Y.....	60	FTGL.....	66	LKS39.....	26	NRS18M200.....	30
148B.....	60	FTGO.....	66	LKS59.....	26	NRS18M330.....	30
148GO.....	60	FTGP.....	66	LKS78.....	26	NRS30M.....	30
148R.....	61	FTGR.....	66	LKS7839.....	26	NRS50M.....	30
148W.....	60	FTO.....	66	LKS98.....	26	OB1000.....	63
148Y.....	60	FTP.....	66	LKTFM.....	27	OB250.....	63
5BD.....	62	FTR.....	66	LKTFRM.....	27	OB500.....	63
5BLACKD.....	62	FTW.....	66	LKTRF.....	27	OT1090.....	63
5RD.....	62	FTY.....	66	LKTSF.....	27	OT275.....	63
8B.....	60	G100.....	58	LP72.....	65	OT545.....	63
8BLACK.....	61	G100BOLD.....	57	LP72R.....	65	OTR100M.....	36
8GL.....	60	G100C.....	58	LP72WHITE.....	65	OTR100MM.....	36
8GO.....	60	G110.....	58	MC10100.....	37	OTR10100.....	36
8R.....	61	G110D.....	58	MC1050.....	37	OTR10165.....	36
8W.....	60	G130.....	58	MC10M100.....	37	OTR10200.....	36
8Y.....	60	G150.....	58	MC10M50.....	37	OTR10300.....	36
BT1211.....	66	G150C.....	58	MC18100.....	37	OTR1050.....	36
BT1214.....	66	G3X.....	58	MC18100.....	37	OTR10M100.....	36
BT511.....	66	G3X100.....	58	MC1810100.....	37	OTR10M165.....	36
BT514.....	66	G3X150BOLD.....	57	MC181050.....	37	OTR10M200.....	36
BWB1000.....	63	GB1000.....	63	MC1850.....	37	OTR10M300.....	36
BWB250.....	63	GB250.....	63	MC18M100.....	37	OTR10M50.....	36
BWB500.....	63	GB500.....	63	MC18M50.....	37	OTR15M.....	36
CMBBULK.....	65	GT1090.....	63	MP201.....	12	OTR15MM.....	36
CMBKBULK.....	65	GT275.....	63	MP301.....	11	OTR18100.....	36
CMYBULK.....	65	GT545.....	63	MP301DM.....	11	OTR1810100.....	36
CS16.....	64	HMBULKW.....	65	MP301M.....	11	OTR1810200.....	36
CS20.....	64	K1.....	56	MP315M.....	12	OTR1810300.....	36
D18646.....	50	K3X.....	56	MP401.....	11	OTR181050.....	36
DG10018.....	51	K3XPRO.....	55	MP401E.....	10	OTR18165.....	36
DG15M.....	51	LCBLACK.....	65	MP401P.....	11	OTR18200.....	36
DG20018.....	51	LCBLUE.....	65	MP415.....	12	OTR18300.....	36
DG2518.....	51	LCGPINK.....	65	NR100.....	31	OTR1850.....	36
DG30018.....	51	LCRED.....	65	NR10100.....	31	OTR18M100.....	36
DG30M.....	51	LCWHITE.....	65	NR10100E.....	31	OTR18M165.....	36
DG5018.....	51	LCYELLOW.....	65	NR10100H.....	31	OTR18M200.....	36
DG50M.....	51	LKB24.....	22	NR10200.....	31	OTR18M300.....	36
FDT2BEL.....	67	LKB24M.....	23	NR10200E.....	31	OTR18M50.....	36
FDT2BFOL.....	67	LKB32.....	22	NR10200H.....	31	OTR18M50.....	36
FDT2BGL.....	67	LKB32M.....	23	NR18100.....	31	OTR30M.....	36
				NR18165.....	31	OTR30MM.....	36

OTR50M.....	36	PG25.....	46	RRT6.....	13	VPMBK.....	65
OTR50MM.....	36	PG2510.....	46	RRT610.....	13	VPMR.....	65
OTRS10100H.....	35	PG5M.....	40	RRT6M.....	13	VPMW.....	65
OTRS10200H.....	35	PG8M.....	40	SH500.....	65	VPMY.....	65
OTRS10300H.....	35	PGPRO1812V.....	45	SNR100M.....	29	WB1000.....	63
OTRS18100.....	35	PGPRO1816V.....	45	SNR100ME.....	29	WB250.....	63
OTRS1810100.....	35	PGPRO1825.....	45	SNR100MH.....	29	WB500.....	63
OTRS1810100E.....	35	PGPRO1825V.....	45	SNR10100.....	29	WR1810.....	49
OTRS1810200.....	35	PGPRO1830.....	45	SNR10100H.....	29	WR1818.....	49
OTRS1810200E.....	35	PGPRO1835V.....	45	SNR10200.....	29	WR1818X.....	49
OTRS1810300E.....	35	PGT1033V.....	41	SNR10200H.....	29	WR18BL.....	49
OTRS1810330.....	35	PGT181012V.....	41	SNR10300.....	29	WR18M.....	49
OTRS18200.....	35	PGT181025V.....	41	SNR10300E.....	29	WT1090.....	63
OTRS18300.....	35	PGT181033V.....	41	SNR10300H.....	29	WT275.....	63
OTRS18M100.....	35	PGT1810V.....	41	SNR18100.....	29	WT545.....	63
OTRS18M200.....	35	PGT1812V.....	41	SNR18200.....	29	YB1000.....	63
P100.....	57	PGT1816V.....	41	SNR18300.....	29	YB250.....	63
PA14.....	17	PGT1825V.....	41	SP16B.....	64	YB500.....	63
PA35.....	17	PGT1830V.....	41	SP16G.....	64	YT1090.....	63
PB1000.....	63	PGT1833V.....	41	SP16RO.....	64	YT275.....	63
PB250.....	63	PGT18M10V.....	41	SP16W.....	64	YT545.....	63
PB500.....	63	PGT18M16V.....	41	SP20B.....	64		
PD618.....	50	PGT18M25V.....	41	SP20BK.....	64		
PG10.....	50	PGT3MV.....	41	SP20G.....	64		
PG1012.....	40	PGT5MV.....	41	SP20GO.....	64		
PG1016.....	40	PGT8MV.....	41	SP20GP.....	64		
PG1025.....	40	PGTFD12V.....	41	SP20R.....	64		
PG10M25.....	40	PGTFD16V.....	41	SP20RO.....	64		
PG10M25AL.....	44	PGTFD25V.....	41	SP20W.....	64		
PG1810.....	40	PM103BLACK.....	61	SP20Y.....	64		
PG181012.....	40	PM103BLUE.....	61	SR100M.....	51		
PG181025.....	40	PM103RED.....	61	SR10100.....	51		
PG181025AL.....	44	PM105BLACK.....	61	SR10200.....	51		
PG181025UB.....	42	PM105BLUE.....	61	SR10300.....	51		
PG181025WIDEV.....	43	PM105RED.....	61	SR18100.....	51		
PG181033.....	40	PM8BLACK.....	61	SR18200.....	51		
PG181033UB.....	42	PM8BLUE.....	61	SR18300.....	51		
PG181033WIDEV.....	43	PM8RED.....	61	SR30M.....	51		
PG1812.....	40	PR2M.....	50	SR50M.....	51		
PG1812SQ.....	50	PR610.....	50	SS144BULK.....	65		
PG1816.....	40	PR618.....	50	SS3H.....	65		
PG1816ALVMAG.....	44, 46	PS100.....	65	ST10010.....	32		
PG1816UB.....	42	PT1090.....	63	ST10018.....	32		
PG1825.....	40	PT275.....	63	ST10018M.....	32		
PG1825AL.....	44	PT545.....	63	ST101003X.....	32		
PG1825ALV.....	44	RR102.....	16	ST10503X.....	32		
PG1825VMAG.....	46	RR10M.....	16	ST181003X.....	32		
PG1825UB.....	42	RR110.....	16	ST18100Y.....	32		
PG1825WIDEV.....	43	RR112.....	16	ST18503X.....	32		
PG1830.....	40	RR182.....	16	ST1850Y.....	32		
PG1830UB.....	42	RR30.....	14	ST18M1003X.....	32		
PG1830WIDEV.....	43	RR3010.....	14	ST18M100Y.....	32		
PG1835WIDEV.....	43	RR30M.....	14	ST18M503X.....	32		
PG1835VMAG.....	46	RR310.....	15	ST5010.....	32		
PG1835.....	40	RR318N.....	15	ST5018.....	32		
PG186KC.....	47	RR3M.....	15	STK21B.....	67		
PG18M6KC.....	47	RR40.....	14	STK21G.....	67		
PG18M10.....	40	RR410.....	15	STK21GL.....	67		
PG18M16.....	40	RR418.....	15	STK21GO.....	67		
PG18M25.....	40	RRPA18.....	17	STK21GP.....	67		
PG18M25AL.....	44	RRPA182.....	17	STK21GR.....	67		
PG18M25UB.....	42	RRT12.....	13	STK21W.....	67		
PG18M25WIDEV.....	43	RRT1210.....	13	STK21Y.....	67		
PG18M26VMAG.....	46	RRT12M.....	13	VPMB.....	65		

ENHANCE YOUR PRECISION

WORK WITH THE WORLD'S MOST ACCURATE BOX BEAM LEVELS

THE SPECIALIST IN MEASURING AND MARKING TOOLS FOR CONSTRUCTION

SOLA offers a wide range of premium-quality measuring and marking tools for construction professionals. With a product range of more than 1,500 items, we support craftsmen across the world in achieving their objectives with higher precision and productivity.

PATENTED FOCUS VIAL

- › Quicker and much easier to read
- › +60% magnification of bubble
- › 4x higher contrast over ring vials
- › No split bubble



HIGHEST PRECISION

- › Standard position:
 $\leq 0.0003 \text{ in./in. (} 0.017^\circ, 0.30 \text{ mm/m)}$
- › Inverted position:
 $\leq 0.0005 \text{ in./in. (} 0.029^\circ, 0.50 \text{ mm/m)}$

PREMIUM MEASURING AND MARKING TOOLS MADE IN AUSTRIA SINCE 1949



Box beam levels



Precision spirit levels



Short levels



Digital levels



Pencils



Deep hole markers



810 N. COMMERCE STREET
AURORA, ILLINOIS 60504

800.345.3766 • FAX: 800.345.8849 • WWW.KESON.COM • SALESORDERS@KESON.COM