

NICOLOCK[®]

PAVING STONES • RETAINING WALLS • OUTDOOR LIVING



SUMMERSET



GRILLS



26", 32", 40" SIZZLER
Shown with Optional Rotisserie Kit



32", 40" SIZZLER PRO
Shown with Optional Rotisserie Kit



32", 38", TRL / 44" TRLD



THE OVEN



SIDE BURNERS



SINGLE SIDE BURNER
SSSB1



SIZZLER DOUBLE SIDE BURNER
SIZSB2



SIZZLER PRO LIGHTED
DOUBLE SIDE BURNER
SIZPROSB2



TRL LIGHTED DOUBLE
SIDE BURNER
TRL SB2



SEAR SIDE BURNER
TRLS5



TRL LIGHTED POWER BURNER
TRLPB2



FREE STANDING CARTS



SUMMERSET SIZZLER CART
CART-SIZ



SUMMERSET SIZZLER PRO CART
CART-SIZDC



SUMMERSET TRL DELUXE CART
CART-TRLDC



OVEN CART
CART-OVEN



REFRIGERATION



21" 4.5C COMPACT REFRIGERATOR
SSRFR-21S
Reversible Door



21" 4.5C DELUXE COMPACT REFRIGERATOR
SSRFR-21D / SSRFR-21DR
Available with Right Opening Door



24" 5.3C DELUXE OUTDOOR RATED 2-DRAWER REFRIGERATOR
SSRFR-24DRZ



24" OUTDOOR RATED DUAL ZONE WINE COOLER
SSRFR-24W / SSRFR-24WD
Available in Single Zone



24" 6.6C DELUXE OUTDOOR RATED KEGERATOR (SINGLE / DOUBLE TAP TOWER)
SSRFR-24DK1 / SSRFR-24DK2



24" 5.3C OUTDOOR RATED REFRIGERATOR
SSRFR-24S / SSRFR-24SR
Available with Right Opening Door



24" 5.3C DELUXE OUTDOOR RATED REFRIGERATOR
SSRFR-24D / SSRFR-24DR
Available with Right Opening Door



15" OUTDOOR RATED FRIDGE WITH GLASS DOOR
SSRFR-15G
Available with Stainless Door



15" OUTDOOR RATED DUAL ZONE WINE COOLER
SSRFR-15WD
Available in Single Zone

ICE CHESTS



17" 1.7C DROP-IN COOLER (20LB ICE CAPACITY)
SSIC-17



28" 2.7C DROP-IN COOLER (40LB ICE CAPACITY)
SSIC-28



15" DROP-IN SINK & HOT/COLD FAUCET
SSNK-15D

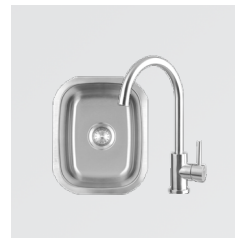

19" UNDERMOUNT SINK & 360° HOT/COLD FAUCET
SSNK-19U



30" LIGHTED BEVERAGE & PREP STATION
SSBC-30L

SINKS AND BAR PREP



OUTDOOR KITCHEN COMPONENTS

STORAGE DRAWERS



20" VENTED LIQUID PROPANE TANK OR TRASH DRAWER
SSDR1-20LP / SSTD1-20



17" DOUBLE DRAWER
SSDR1-17 / SSDR2-17 / SSDR3-17
Available as Single and Triple Drawer



26" UTENSIL DRAWER
SSDR1-26U



17" PAPER TOWEL HOLDER
SSTH-17



32" DOUBLE HORIZONTAL DRAWER
SSDR2-32H

ACCESS DOORS



33" VENTED DOUBLE ACCESS DOOR
SSDD-33V

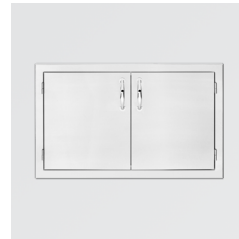

DOUBLE ACCESS DOOR (26"-45")
SSDD-26 / SSDD-30 / SSDD-33 / SSDD-36
SSDD-39 / SSDD-42 / SSDD-45



VERTICAL ACCESS DOOR (16", 18", 20")
SSDV-16 / SSDV-18 / SSDV-20

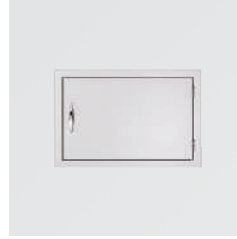

HORIZONTAL ACCESS DOOR
SSDH-18 / SSDH-22 / SSDH-27

DOOR/DRAWER COMBOS



2-DRAWER & ACCESS DOOR COMBO (30", 33", 36", 42")
SSDC2-30" / SSDC2-33" / SSDC2-36" / SSDC2-42"



30" 3-DRAWER & ACCESS DOOR COMBO
SSDC3-33



30" 2-DRAWER & LP TANK PULLOUT DRAWER COMBO
SSDC2-33LP



17" VERTICAL 2-DRAWER & PAPER TOWEL HOLDER COMBO
SSTDC-17

DRY STORAGE



36" 2-DRAWER DRY STORAGE PANTRY & ENCLOSED CABINET COMBO

SSDP-36DC



36" 2-DRAWER DRY STORAGE PANTRY & ACCESS DOOR COMBO

SSDP-36DC



36" WARMING DRAWER

SSWD-36



MADERA REAL WOOD COMPONENTS

MADERA DRY STORAGE

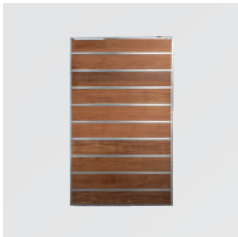

20" MADERA FULL HEIGHT VERTICAL DRY STORAGE PANTRY
SSMP-20V

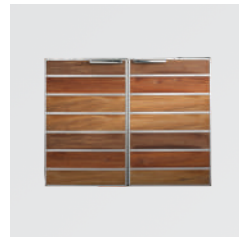
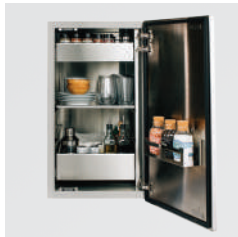

30" MADERA HORIZONTAL DRY STORAGE PANTRY
SSMP-30DC

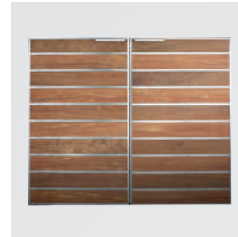

40" MADERA FULL HEIGHT VERTICAL DRY STORAGE PANTRY
SSMP-40V



MADERA ACCESS DOORS

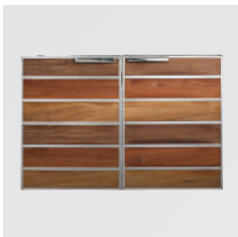

30" MADERA DOUBLE ACCESS DOOR
SSMDD-30

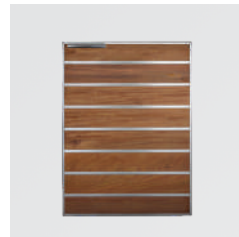

20" MADERA VERTICAL ACCESS DOOR
SSMDV-20



MADERA COMBOS

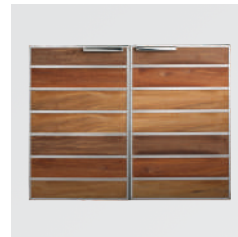

30" MADERA DRY STORAGE 2-DRAWER & ACCESS DOOR COMBO
SSMDP-30AC



MADERA DRAWERS

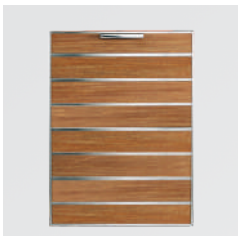

20" MADERA DOUBLE TRASH / RECYCLING 2-BIN PULLOUT DRAWER
SSMTD2-20

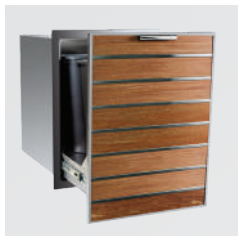

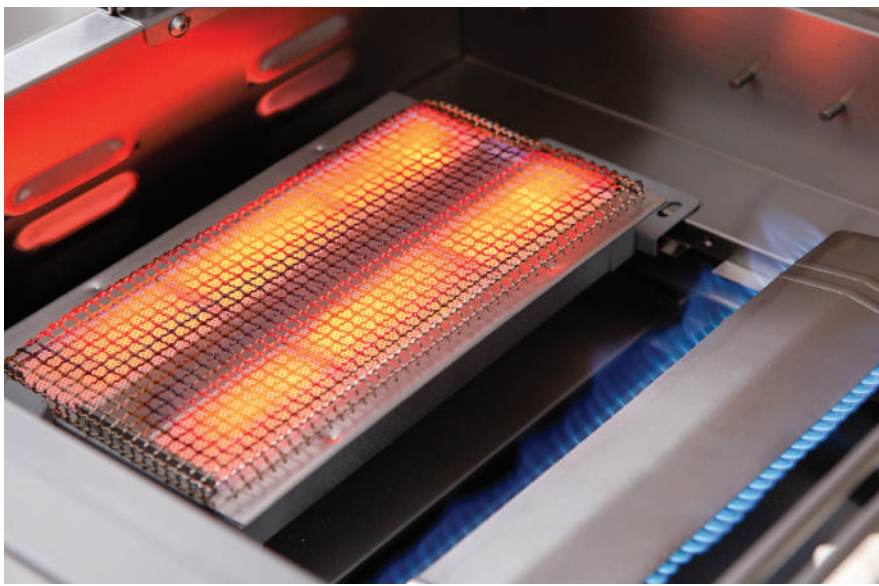

GRILL AND ISLAND ACCESSORIES

GRILL & SIDE BURNER LINERS



GRILL LINER
GL



SIDE BURNER LINER
GL

SIZZLER/ SIZZLER PRO SIDE BURNER BRACKET



SIDE BURNER BRACKET
CART-SIZ-SB2BK

SEAR BURNERS

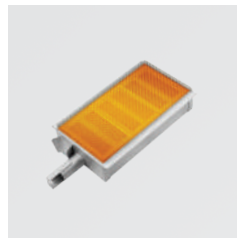

INFRARED SEAR BURNER
IRB-SIZ / IRB-TRL

ROTISSERIE KITS



SUMMERSET ROTISSERIE KITS
ROTKIT

SMOKER TRAYS



SMOKER TRAYS
SSMK-SIZ / SSMK-TRL

GAS TIMER / MOUNTING PLATES



GAS TIMER WITH EMERGENCY SHUTOFF / MOUNTING PLATE
ESTOP1-0H / ESTOP2-SH

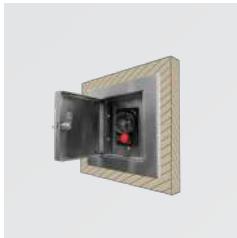

GAS TIMER WITH LOCKING CABINET
ESTOP-LC-KIT / ESTOP-RM-KIT
From Super Surface Mount Installation



EXPANDABLE MASONRY GAS TIMER KIT
ESTOP-CP-KIT

CUTTING BOARD & TRASH CHUTE



14" TRASH CHUTE & CUTTING BOARD WITH LID
SSTC-14

SUMMERSET GRIDDLE



14" SUMMERSET GRIDDLE PLATE
SSGP-14

VENT HOODS



VENT HOOD (36", 48", 60")
SSVH-36 / 48 / 60



SUMMERSET'S LIFETIME WARRANTY

Summerset Professional Grills is backed by the strongest warranty in the industry! In addition to precision engineering and outstanding performance, Summerset grill series include a LIFETIME WARRANTY. Now you can use a grill with the peace of mind that you have an industry leading warranty.

SUMMERSET GRILL SERIES

- Lifetime Warranty on construction and manufacturer defects
- Lifetime Warranty on frame and housing
- Lifetime Warranty on cooking grates, burners and valves
- 1 year Warranty on all other parts, components, and electrical

COMPONENTS

- Lifetime Warranty on construction, workmanship and materials for all stainless steel components, including doors, drawers, ice chests, beverage centers, sinks and grill liners
- 1 year on all other parts and electrical
- Limited (5 year) Warranty on carts
- Limited (1 year) Warranty on grill covers

REFRIGERATION

- 2 year warranty on all construction and compressor (SSRFR-21S, SSRFR-21D, SSRFR-21DR, SSRFR-24S, SSRFR-24SR, SSRFR-24W, SSRFR-24WD, SSRFR-15G, SSRFR-15S, SSRFR-15WD, SSRFR-15W)
- 3 year warranty on all construction and compressor (SSRFR-24D, SSRFR-24DR, SSRFR-24DK1, SSRFR-24DK2, SSRFR-24DR2)
- 1 year warranty on all electrical components

MADERA PRODUCTS

- Lifetime warranty on construction, workmanship and materials for all stainless steel components

CUTOUTS

For cutouts, dimensions or more information on your Summerset product, visit Summersetgrills.com/cutouts or scan this QR Code with your smartphone's camera app.

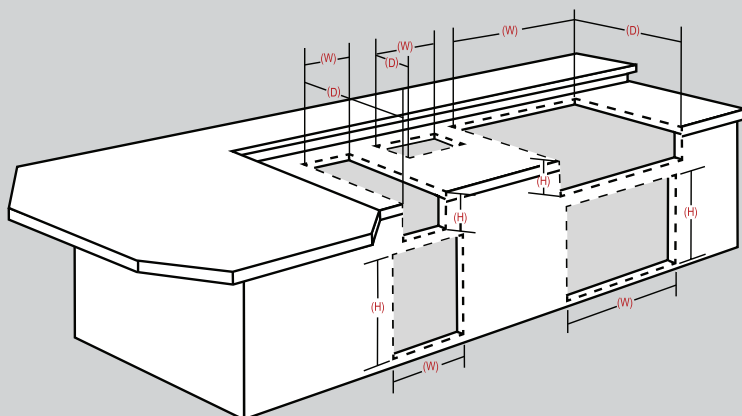

Summerset's Lifetime Warranty is valid for original purchaser at original site of delivery with proof of purchase and photo documentation only. Registration form must be submitted within 30 days of the purchase date to validate the warranty. Warranty is void upon transfer of ownership. Warranty does not apply to products installed in any commercial, rental, or non-residential application. Warranty covers replacement parts only. Manufacturer is not responsible for labor or labor-related costs. Warranty does not cover discoloration, surface rust, corrosion, or oxidation, which may occur due to harsh environments, chemicals, or overheating. Warranty will not apply for damage resulting from improper installations, abuse, extreme environments, grease fires, or misuse. Regular and proper maintenance is required. Coastal, humid, and/or salt environments are subject to manufacturer review. All out-of-box claims must be made within 30 days of purchase and must be made prior to installation. Any product installed damaged will be considered damaged during installation and not covered under warranty. Warranty and registration forms are available at www.SummersetGrills.com. Please be advised - all display models are sold "as is" and the warranty covers the following items only: main burners (Lifetime), grates (Lifetime), burner covers (1 year). All warranties are subject to the review and approval of the manufacturer.